

# Process Analytics Catalog

**INGOLD**

Leading Process Analytics

**THORNTON**

Leading Pure Water Analytics

International  
2020



pH  
DO & Ozone  
CO<sub>2</sub>  
TOC/Microbial Detection  
Conductivity/Resistivity  
Turbidity  
Housings & Cleaning Systems  
Sodium/Silica Analyzers  
Chloride/Sulfate Analyzer  
Gas Analyzers



## Process Analytics Measurement Solutions for Industrial Applications

**METTLER TOLEDO**

# METTLER TOLEDO's Distribution Network

## Worldwide

**METTLER TOLEDO provides full sales and service coverage worldwide. Wherever our customers are, we are the competent partner. Many global manufacturers rely on our long-standing experience to ensure the highest levels of product and process quality control.**

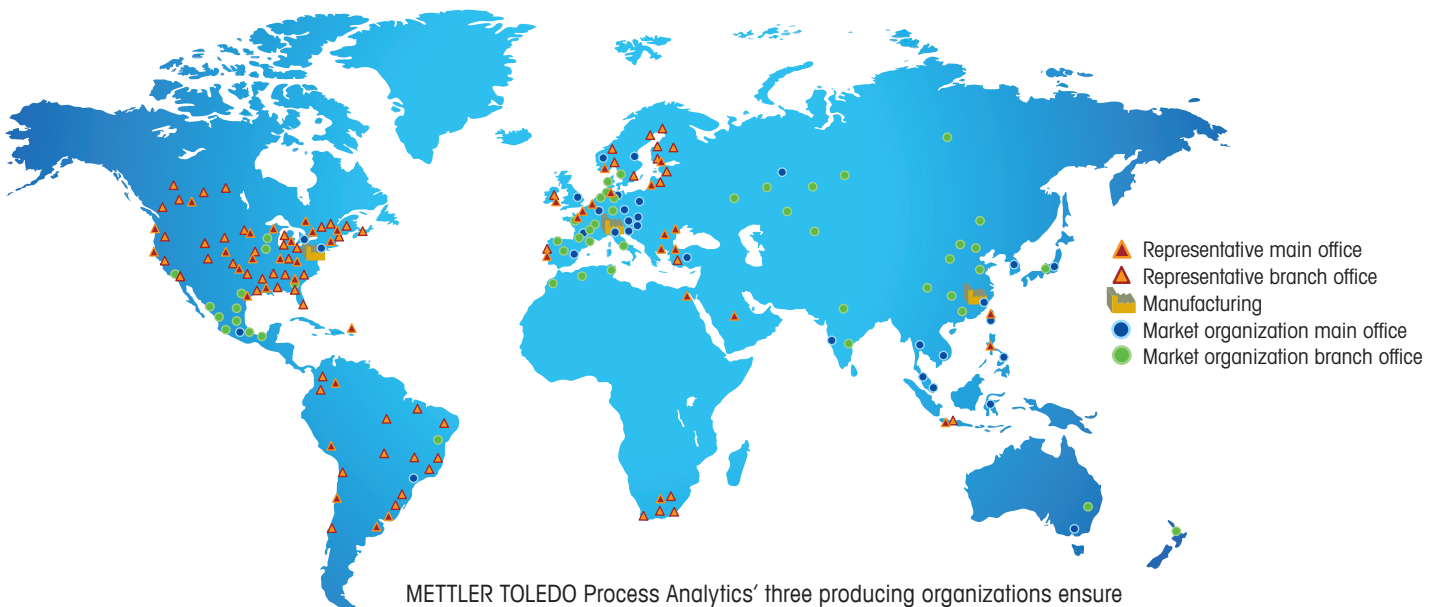

### Distribution network

Based at several global production sites, with more than twenty market organizations, and numerous sales representatives, METTLER TOLEDO maintains a distribution network all around the world. Satisfaction of our customers is based on three pillars:

- Consulting
- Products
- After-sales service

Our highly skilled experts are at your disposal to support you in finding the best solution for your measurement application, including planning, product selection, and installation.

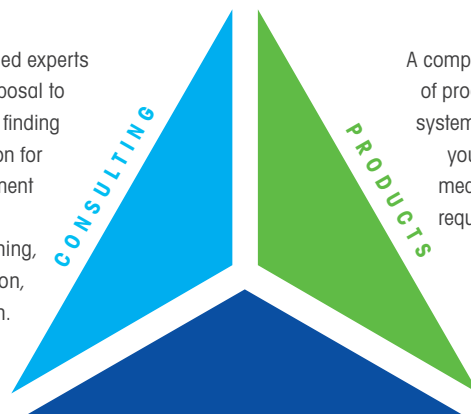

A complete range of products and systems to meet your specific measurement requirements.

### AFTER-SALES SERVICE

With our customized, lifelong service management, we are able to assist in managing measurement loops throughout their entire life cycle.

**INGOLD**

Leading Process Analytics

---

**THORNTON**

Leading Pure Water Analytics

---

# **Process Analytics Measurement Solutions**

---

## for Industrial Applications

# Table of Contents

## Process Analytics Catalog

<b>■ Introduction</b>			
About METTLER TOLEDO	4	InPro 5000 i	56
Tools and Services	6	InPro 5500 i	58
System Integration	8		
Intelligent Sensor Management (ISM)	10	<b>■ Turbidity/Optical Density</b>	
		Versatile Turbidity Measurement	60
<b>■ Ingold</b>		InPro 8050/InPro 8100 (Single Fiber)	62
<b>■ pH</b>		InPro 8200 (Dual Fiber)	64
pH and ORP Systems	14	InPro 8300 RAMS Series	66
METTLER TOLEDO pH Electrodes	16		
InPro 2000 (i)	18	<b>■ Conductivity</b>	
InPro 3100 (i)	20	Conductivity/Resistivity Systems	68
InPro 3250 (i)	22	InPro 7000-VP	70
InPro 3300	24	InPro 7100-VP	72
InPro 4010	25	InPro 7100 (i)	74
InPro 4260 (i)/InPro 4281 i	26	InPro 7250	76
InPro 4550/InPro 4501	28		
InPro 4800 (i)/InPro 4881 i	30	<b>■ Transmitters</b>	
InPro 4850 i	32	Transmitters for All Parameters	78
Puncture pH Electrodes	34	M200	80
pH Buffers, Electrolytes, Cleaning and Storage Solutions	35	M300 Process	82
Pro2Go Portable pH/ORP Meter	36	M400 4-wire	84
		M700	88
		M800	90
		M100 Head Mount	93
<b>■ Dissolved Oxygen</b>		M100 DIN Rail	94
Dissolved Oxygen Measurement Systems	38	M100 Sensor Mount Transmitter	95
InPro 6860 i Optical Oxygen Sensor	40	M80 Sensor Mount Transmitter	96
Powering Accessories for InPro 6860 i	42	M400 2-Wire	98
InPro 6960 i/InPro 6970 i Optical Oxygen Sensor	44		
InPro 6800/InPro 6850 i (12 & 25 mm)	46	<b>■ ISM Productivity Tools</b>	
InPro 6900 (i)/InPro 6950 i	48	iSense	102
InTap: Portable Optical DO Analyzer	50	Verification Kits	104
InPro 6050	52		
Oxygen Accessories and Spare Parts	53	<b>■ Housings</b>	
		Process Connection Hardware	106
<b>■ Dissolved Carbon Dioxide</b>		Sockets, Flanges, and Plugs	108
In Situ Monitoring of Dissolved CO <sub>2</sub> in Bioreactors	54	InFit 761 e	110
In-line CO <sub>2</sub> Measurement in Beverages	55	InFit 764 e	111

InFit 762 e/763 e	112	<b>pH Electrodes</b>	
InDip 500 Series	113	pH and ORP Systems	162
InFlow Series	114	pH/ORP Sensors with ISM	164
Product Configurators and Sensor Fit Guides for InFit, InFlow and InDip Housings	115	pHure Sensor with ISM	166
InTrac 776 e	118	pHure Sensor LE with ISM	168
InTrac 777 e/779 e	119	pH/ORP Housings, Buffer Solutions	170
InTrac 797 e/799 e	120	<b>Dissolved Oxygen and Ozone Sensors</b>	
InTrac 781 /784	121	Oxygen Measurement Systems	172
InTrac 785/787	122	Ozone Measurement Systems	173
Product Configurators and Sensor Fit Guides for InTrac Housings	123	Pure Water Optical DO Sensor	174
		High Performance DO Sensors with ISM	176
		pureO <sub>3</sub> Dissolved Ozone Sensor with ISM	178
<b>Automation</b>		<b>Total Organic Carbon (TOC)</b>	
EasyClean	126	Total Organic Carbon (TOC)	180
EasyClean Configuration	127	4000TOC e	182
EasyClean 400	128	6000TOC i	184
EasyClean 200 e	129	450TOC	188
EasyClean 150/100	130	TOC Pump Module	190
EasyClean Ordering Information	131	<b>Microbial Detection Analyzer</b>	
		7000RMS	192
<b>Cables</b>		<b>Sodium Analyzer</b>	
Cables and Connections	132	2300 Na Sodium Analyzer	194
Cable Terminations	133	<b>Silica Analyzer</b>	
Cable Availability Cross Reference Table	134	2850Si Silica Analyzer)	196
		<b>Ion Analyzer</b>	
<b>Gas Analytics</b>		3000 CS Chloride/Sulfate Analyzer	198
<b>Rethinking Gas Analytics</b>		<b>Transmitters</b>	
Introduction	138	Transmitters for All Parameters	200
Gas Oxygen Sensors and Analyzers	140	M200	202
Measurement Theory	142	M300 Water	206
GPro 500 Sensor	144	M800 Multi-Parameter, Multi-Channel Transmitter	210
InPro 6000G Sensor Series	148	<b>Trademark Notice</b>	212
<b>Thornton</b>			
<b>Conductivity/Resistivity</b>			
Conductivity/Resistivity Systems	152		
UniCond Conductivity/Resistivity Sensors with ISM	154		
DCC1000 e System with ISM	156		
Analog Conductivity Sensors	158		



#### Info

General information  
about the product



#### Quick Tip

Useful tips and  
tricks for the product



#### Did You Know

Additional and  
helpful information

# METTLER TOLEDO

## The Leader in Process Analytical Measurement

### METTLER TOLEDO Group

METTLER TOLEDO specializes in providing precision instruments with the most comprehensive range of services on a global level. With more than 14,200 employees, the company generates annual sales of over US\$ 2.5 billion. Mettler-Toledo International Inc. has been listed on the New York Stock Exchange since 1997 (MTD).

METTLER TOLEDO instruments are used for critical research and development applications and also for quality control purposes. The pharmaceutical, micro-electronics, chemical, food & beverage, and cosmetic industries are among the principal users.

METTLER TOLEDO enjoys an excellent reputation as an innovator, and currently invests more than US\$ 120 million per

year in research and development, having increased overall R & D spending. METTLER TOLEDO makes every effort to meet the highest quality standards, resolutely applying Total Quality Management at both the product and process level, but specifically as part of our support for customers to comply with international guidelines.

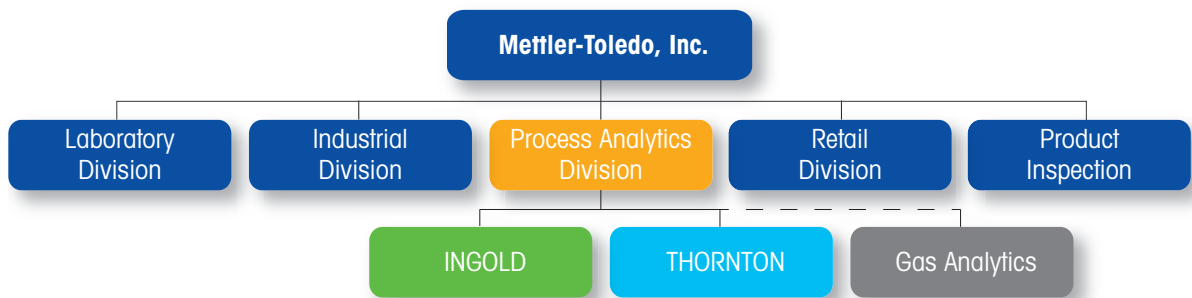

### METTLER TOLEDO Process Analytics

Within the METTLER TOLEDO Group, the Process Analytics division concentrates on analytical measurement solutions for industrial manufacturing processes. The division consists of two business units: Ingold and Thornton, both recognized leaders in their respective markets and technologies. Ingold is a worldwide leader in pH, dissolved oxygen, CO<sub>2</sub>, conductivity

and turbidity solutions for process analytical measurement systems in chemical, food & beverage, biotechnology and pharmaceutical industries. Its core competence is high quality in-line measurement of these parameters in demanding chemical process and hygienic and sterile applications. Thornton is the leader in pure and ultrapure water monitoring instrumentation used in semiconductor,

microelectronics, power generation, pharmaceutical, and biotech applications. Its core competence is the in-line measurement of conductivity, resistivity, TOC, bioburden, dissolved oxygen and ozone in determining and controlling water purity. The division recently expanded into Gas Analytics with a series of TDL analyzers offering unique in situ solutions.

### Ingold – Leading Process Analytics

Ingold has a long track record of innovative high-quality solutions for demanding process analytics applications.

Ingold was founded in 1948 by Dr. Werner Ingold. Today, Ingold provides the broadest range of in-line analytical measurement solutions for industrial processes in the biotechnology, pharmaceutical, chemical, and beverage industries. Ingold offers systems for the measurement para-

meters of pH/ORP, dissolved oxygen (DO), dissolved CO<sub>2</sub>, conductivity and turbidity.

Latest developments include optical DO sensors and intelligent in-line sensor management solutions for optimized maintenance management in demanding applications.



### Thornton – Leading Pure Water Analytics

Thornton is the market leader in critical ultrapure and pure water analytics, where accuracy and reliability are essential.

Thornton Inc., founded in 1963 by Dr. Richard Thornton, a Professor at Massachusetts Institute of Technology, has been part of the Process Analytics Division since 2001. Thornton offers innovative analytical instruments and sensors for the measurement of resistivity, conductivity, TOC, bioburden, pH, dissolved oxygen (DO), sodium, silica and ozone.

Thornton instrumentation is trusted globally in the pharmaceutical, biotech, power generation and microelectronics sectors. With the introduction of its microbial contamination analyzer, Thornton is the world's only producer of conductivity, TOC and bioburden measurement solutions for USP-regulated ultrapure waters.



### Rethinking Gas Analytics – Measure where it really matters

Providing innovative in situ TDL solutions for compact installations, alignment-free and easy-to-use.

In Gas Analytics we provide a broad range of in situ and at-line analytical measurement solutions for industrial processes in the chemical, petrochemical, refining and pharmaceutical industries. Our innovative sensors and analyzers cover oxygen, carbon monoxide, car-

bon dioxide, hydrogen sulfide, hydrogen chloride, methane, ammonia and water vapor, with more parameters to come.

The employed tunable diode laser and optical technology combine high measurement accuracy with ease of installation and use.



## www.mt.com/pro

### Fast and Competent On-line Support

Visit our website at any time for fast and competent information. The very latest, updated product and support documentation is available in many different languages.

#### ■ Unlimited access

##### What you need:

- Fast access to product documentation
- Suitable process analytical solution
- Access to certificates

##### What we offer:

- Information on products and measurement solutions
- Success stories about our solutions in your industry
- Country specific information and service offerings
- Personalized access
- Multilingual information
- Extensive download offerings

#### ■ Complete measuring solutions

##### We provide measuring systems for:

- pH/ORP
- Dissolved O<sub>2</sub>/O<sub>2</sub> in gas phase
- Dissolved CO<sub>2</sub>
- Conductivity/Resistivity
- Bioburden
- TOC
- Sodium and Silica
- Chloride, Sulfate ions
- O<sub>3</sub> (dissolved ozone)
- Turbidity

##### Find our offerings in:

- Pharmaceutical processes
- Biotech and hygienic processes
- Chemical and petrochemical processes
- Water purification processes
- Wastewater applications





# Customer Service/Technical Service

## Seven Reasons to Choose METTLER TOLEDO

**Customer service at METTLER TOLEDO strives to provide you with added value including professional product services as well as leading edge technical support.**

### **Our focus is customer success**

The METTLER TOLEDO organization has the largest, best-trained global service network in the industry. Our worldwide presence and reputation for outstanding quality make us the logical choice not only to provide classical services but also for services that go far beyond those of other providers.

We understand that customers today are interested in value-added solutions that give them competitive advantages in the marketplace. And that is what we endeavor to deliver. Providing the highest levels of service and customer satisfaction is very important to METTLER TOLEDO Ingold/Thornton and we understand that you expect not only the highest quality products, but also superior customer and technical support when you need it.

Service from METTLER TOLEDO goes far beyond the initial purchase. We pride ourselves in being available for you, whether it is to answer a technical question, provide details on system operation or to manage requests for service.

When you purchase products from METTLER TOLEDO you have the satisfaction of relying on proven products in your process and having a world class service organization standing behind them.

METTLER TOLEDO offers comprehensive, tailored service plans to meet your needs. Please contact your local METTLER TOLEDO representative for your individual solution. Please see the phone number of your local representative on the last page of this catalog.

### **Our customers benefit from**

- **Quicker repairs and calibration**
- **Reliable, professional, efficient service**
- **Fast response time**
- **Higher system "uptime"**
- **Innovative and leading edge support services that meet future needs**
- **Regulatory compliance**
- **Improved productivity and enhanced competitiveness**



## Asset Management and Plant Maintenance With HART, FOUNDATION Fieldbus and PROFIBUS

**Open fieldbus integration of your process analytical measurement technology into your control system via digital fieldbus technology.**

Open fieldbus protocols such as HART, FOUNDATION fieldbus and PROFIBUS are currently regarded as standard in the process industry. Only fieldbus technology enables full use of the functional advantages of digital communication to be able to achieve improved resolution of measured values, intelligent instrument diagnostics and new control strategies.

### **METTLER TOLEDO integration with HART, FOUNDATION fieldbus and PROFIBUS**

These standardized communication protocols allow a central overview of the whole plant network. In addition, they offer the opportunity of comfortable instrument configuration and a higher level of process information to improve plant performance. Field process instrumentation becomes an integral part of the control and operation level. This technology provides an optimized and continuously available interface for your plant management and maintenance planning.

### **Integrated device descriptions**

Our intelligent analytical instruments include electronic device descriptions (DD) for various process instrument configuration software tools to support seamless integration into the control and engineering level.

### **Fieldbus communication in connection with asset management and predictive maintenance and information**

By applying HART, FOUNDATION fieldbus or PROFIBUS, seamless integration of advanced Intelligent Sensor Management (ISM) diagnostics information into your process control system is guaranteed.

The use of asset management and predictive maintenance are an important element in improving plant management. The fieldbus technology of HART, FOUNDATION fieldbus and PROFIBUS supports the online status integration information requirements in an unprecedented way.

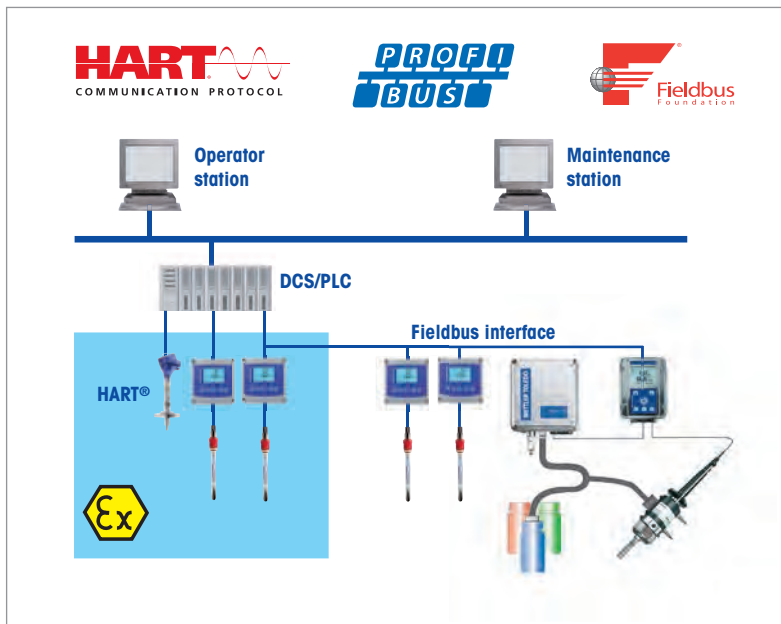



## Intelligent Sensor Management

### Predictive Maintenance for Process Analytics

**ISM®, a breakthrough technology from METTLER TOLEDO, allows users of process analytical equipment to benefit from accurate diagnostics that predict when sensor maintenance will be required, while also increasing production process safety.**

#### What exactly is ISM?

It is a digital technology that incorporates intelligent algorithms into sensors and analyzers. The combination of on-board microprocessors and algorithms that actually learn from

process conditions, simplifies sensor and analyzer handling and workflows. ISM delivers a level of performance that analog systems simply cannot provide, including:



#### Increased accuracy and measurement confidence

With ISM the process parameter value is calculated directly in the sensor, resulting in higher accuracy than analog probes. Moreover, the digital signal is unaffected by plant conditions and is stable over long cable runs, providing you with greater assurance in your processes.

#### Online sensor diagnostics

ISM sensors continuously check themselves for wear. Inside the probe sophisticated algorithms learn from process variables to calculate when sensor calibration or replacement will be due. The Adaptive Calibration Timer and Dynamic Lifetime Indicator allow you to use your resources more efficiently.

#### Easy, error-free operation

ISM sensors store their own calibration data. They can be quickly and accurately calibrated away from the process in any suitable location. When they are connected to an ISM transmitter, this data is uploaded and the transmitter configures itself automatically.

#### ISM sensor offering

The parameters covered by ISM sensors is wide and includes:

- pH/ORP
- dissolved oxygen
- gas phase oxygen
- dissolved carbon dioxide
- conductivity
- TOC

## Reasons to switch to ISM

ISM reduces signal noise

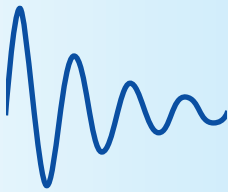

ISM lowers operating costs



ISM simplifies compliance



ISM means easy handling



Discover more reasons to switch to ISM at: ► [www.mt.com/ism](http://www.mt.com/ism)





# Process Analytics Measurement Solutions for Industrial Applications

## pH and ORP Systems For Harsh Industrial to Pure Water Applications

**With many decades of experience in designing pH/ORP electrodes, METTLER TOLEDO offers a state-of-the-art solution for practically any type of process analytical application.**

### Functional definition

pH can be described as a measurement of the relative acidity of a solution. Oxidation reduction potential (ORP) as measured with an ORP electrode, provides an indication of the oxidative state of the solution. It is important to measure, and often to control the pH and/or ORP of a solution for several reasons:

- To produce products with consistent well defined properties
- To efficiently produce products at optimal cost

- To avoid health risks
- To protect the environment
- To prevent physical/chemical damage to materials
- To meet regulatory requirements
- To expand scientific knowledge

The accurate measurement of pH/ORP is critical in most industries. Each application has unique physical requirements of chemical, temperature, and pressure resistance and possibly hygienic design. Another factor is what is to be done with the measurement:

monitoring only, data logging or process control.

### pH electrode selection

It is important to understand the details of the application before selecting a pH electrode. The table on page 15 gives an initial glance at the various electrodes available and typical applications. Selection of a pH electrode requires a thorough knowledge of the process. Once the requirements are known, comparison of the electrode specifications detailed in this catalog will identify the appropriate sensor.



InPro 3250i

InPro 4850i

InPro 4260i

InPro 4281i



**Table:**  
**Ingold pH electrode selection guide**  
**by industries and applications**

Refer to page:	<b>Troubleshooter (liquid)</b> InPro 2000(O)/465	<b>Low maintenance (mainly gel)</b> InPro 3100(O)	InPro 3250(O) (liquid)	InPro 4800(O)/InPro 4880i	DPA	DPAS	<b>Low maintenance (solid electrolyte)</b> InPro 4260(O)/InPro 4280i	InPro 4501	InPro 4550	DXK	Puncture pH electrode <b>Low maintenance (dual-membrane)</b> InPro 4850i	
	p. 18	p. 20	p. 22	p. 30	–	–	p. 26	p. 28	p. 28	–	p. 34	p. 32
<b>Industrial Processes</b>												
Chemical production monitoring	•		•	•	•		•	•	•	•		
Chlorine production	•			•								•
Dyestuff production				•			•	•	•	•		
Mining				•			•	•	•	•		
Petroleum & refining	•		•	•			•	•	•			
Pulp & paper	•			•			•	•	•			
<b>Pharmaceutical Industry</b>												
BioPharma												
Upstream	•	•	•			•						
Downstream	•	•	•			•						
ChemPharma	•	•	•			•	•					
<b>Food &amp; Beverage Processes</b>												
Brewery & beverage production	•	•	•									
Dairy												
Milk processing	•		•									
Yogurt production	•	•	•									
Cheese making	•	•	•							•	•	
Meat										•	•	
Wine	•	•	•									
Sugar & starch	•	•	•	•			•	•	•			
Yeast	•	•	•									
Cleaning solutions (CIP)		•	•									
<b>Water Treatment</b>												
Air scrubbers	•			•			•	•		•		
Cooling water	•		•				•	•		•		
Neutralization			•	•	•		•	•		•		
Potable water	•	•	•									
<b>Wastewater Treatment</b>												
Flue gas neutralization	•		•	•			•	•		•		
Galvanic wastewater			•	•	•		•	•		•		
Industrial wastewater				•			•	•		•		
Precipitation of heavy metals	•		•				•	•		•		
Sludge dewatering							•	•		•		

This table serves as an initial selection guide to suitable Ingold pH electrodes for given applications. Since

process conditions vary considerably at different stages of production, it is necessary to refer to the detailed

technical specifications of the electrode to ensure compatibility.

## METTLER TOLEDO pH Electrodes

### The Problem Solvers...Through 60 Years of Innovation!

The design of the pH electrode reflects the potential problems each application may present. On these two pages, application questions are raised, and the METTLER TOLEDO Ingold solutions are described.

#### Is frequent steam sterilization or autoclaving a requirement?

When frequent steam sterilization, autoclaving, or other dramatic process temperature cycling is encountered, the "Argenthal™" reference system maintains a constant concentration of silver chloride at the reference electrode silver wire, providing stable and repeatable reference voltages.

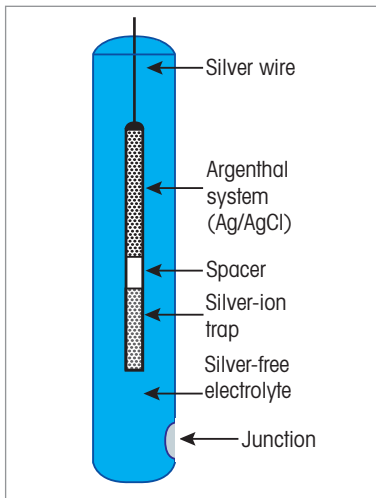

Reference electrode  
Argenthal system/silver-ion trap

#### Does the sample contain components which could react with the reference electrolyte?

One source of problems is the reaction of silver-ions in the reference electrolyte with sulfide or other complexing compounds in the sample medium. The unique Ingold internal "silver-ion trap" prevents silver ions from entering the bulk electrolyte. Alternatively, use of "double junction" electrodes and selection of specialized electrolytes also serve to ensure chemical compatibility.

#### Is a watertight connection required?

The IP 68 watertight cable connection provides excellent signal transmission in all environments.



#### What are the temperature and pressure requirements of the installation?

Temperature and pressure requirements of a process must be met to ensure safe operation of the system as well as accurate performance of the electrode. Electrodes are available with specifications

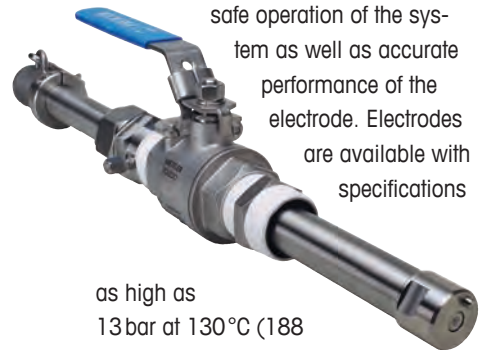

as high as  
13 bar at 130°C (188  
psig at 266°F) to handle  
aggressive process situations.



# InPro 2000 (i) For the Most Extreme Requirements



InPro 2000

InPro 2000i/SG

The InPro 2000 (i) is a combination pH electrode with an integral temperature sensor designed for highly demanding applications. Three liquid electrolytes are available adding versatility; 3M KCl is a classic electrolyte offering high flow for improved junction cleaning, Viscolyt™ has limited flow for reduced maintenance needs, and Friscolyt™ is ideal for process media with high protein or organic solvent content, and in low temperatures. Applications range from biotechnical processes requiring in-situ sterilization to dirty industrial processing chemicals.

### Specifications

pH range	0 – 14 pH
Temperature	0 to 140 °C (32 to 284 °F)
Operating pressure	0 to 6 barg, 0 to 87 psig (in pressurized housing)
Cable connection	ISM: K8S; Analog: VP
Process connection	METTLER TOLEDO Housing Adapter
Reference system	Argenthal with silver-ion trap
Type of junction	Ceramic junction
Reference electrolyte	Selectable; 3M KCl, Viscolyt, or Friscolyt
Lengths	120 mm, 150 mm, 250 mm, 450 mm
Lower shaft diameter	12 mm
Temperature sensor	ISM: Digital; Analog: Pt 100 or Pt 1000
Sterilizable	Yes
Autoclavable	Yes
pH membrane	High alkali glass (HA)

**Certificates and Approvals** METTLER TOLEDO Quality Certificate, Pressure Equipment Directive guidelines (PED) 97/23/EC, ATEX: Ex ia IIC T6/T5/T4/T3 Gα/Gb, FM: IS Cl. I, II, III, Div 1, GR ABCDEFG/T6

### Intelligent Sensor Management (ISM)

pH electrodes with integrated ISM functionality allow Plug and Measure and advanced diagnostics. ISM simplifies the installation, handling and maintenance of measurement equipment. For more information see ISM introduction pages 10–11.

### Features Overview

- User-selectable reference solution allows optimum compatibility with process media
- Flowing liquid electrolyte ensures fast response and accurate pH measurement
- Silver-ion trap prevents sulfide poisoning of junction
- Refillable electrolyte extends operational life
- Domed glass membrane impedes bubble formation for greater reliability
- Watertight connector (IP68)
- Integral temperature sensor, more accurate temperature compensation
- ATEX and FM certification for hazardous areas

▶ [www.mt.com/InPro2000](http://www.mt.com/InPro2000)

## Ordering Information

ISM Electrodes	Length	Electrolyte	Temp. Signal	Order Number
InPro 2000i/SG	120 mm	3M KCl	Digital	52 003 521
InPro 2000i/SG	150 mm	3M KCl	Digital	30 068 948
InPro 2000i/SG	250 mm	3M KCl	Digital	30 068 949
InPro 2000i/SG	450 mm	3M KCl	Digital	30 069 160
InPro 2000i/SG	120 mm	Viscolyt	Digital	52 003 522
InPro 2000i/SG	150 mm	Viscolyt	Digital	52 003 523
InPro 2000i/SG	250 mm	Viscolyt	Digital	52 003 524
InPro 2000i/SG	450 mm	Viscolyt	Digital	52 003 525
InPro 2000i/SG	120 mm	Friscolyt	Digital	52 003 526
InPro 2000i/SG	150 mm	Friscolyt	Digital	52 003 527
InPro 2000i/SG	250 mm	Friscolyt	Digital	52 003 528
InPro 2000i/SG	450 mm	Friscolyt	Digital	52 003 529
<b>Analog Electrodes</b>				
InPro 2000	120 mm	Viscolyt	Pt 100	52 001 426
InPro 2000	120 mm	Viscolyt	Pt 1000	52 001 427
InPro 2000	250 mm	Viscolyt	Pt 100	52 001 428
InPro 2000	250 mm	Viscolyt	Pt 1000	52 001 429
InPro 2000	450 mm	Viscolyt	Pt 100	52 001 738
InPro 2000	450 mm	Viscolyt	Pt 1000	52 001 792
InPro 2000	120 mm	3M KCl	Pt 100	52 001 430
InPro 2000	120 mm	3M KCl	Pt 1000	52 001 431
InPro 2000	250 mm	3M KCl	Pt 100	52 001 432
InPro 2000	250 mm	3M KCl	Pt 1000	52 001 433
InPro 2000	450 mm	3M KCl	Pt 100	52 001 794
InPro 2000	450 mm	3M KCl	Pt 1000	52 001 777
InPro 2000	120 mm	Friscolyt	Pt 100	52 001 434
InPro 2000	120 mm	Friscolyt	Pt 1000	52 001 435
InPro 2000	250 mm	Friscolyt	Pt 100	52 001 436
InPro 2000	250 mm	Friscolyt	Pt 1000	52 001 437
InPro 2000	450 mm	Friscolyt	Pt 100	52 001 655
InPro 2000	450 mm	Friscolyt	Pt 1000	52 001 666

### InPro 2000 (i) Electrolytes

To cope optimally with the conditions prevailing in different types of chemical processes, a wide variety of electrolytes is available:

#### 9816 Viscolyt

Mostly frequently used CP electrolyte with limited outflow and therefore long refill intervals.

#### 9823 KCl

Classic electrolyte with high electrolyte outflow for improved diaphragm cleaning.

#### 9848 Friscolyt

Used for media with proteins/organic solvent content.

### Did You Know

The InPro 2000 (i) is the next generation of the 465 style electrode featuring temperature compensation and VP connection. For other connectors and styles, the 465 also is available. For further information please contact your local sales organization.

Suitable Housings	p.
InFit 763 e.....	112
InFit 764 e.....	111
InTrac 776 e.....	118
InTrac 784 .....	121

## InPro 3100 (i) Versatile and Robust



InPro 3100

InPro 3100i



Also available for upside-down installation as InPro 3100 (i) UD.

The InPro 3100 (i) is a combined pH electrode and temperature sensor designed specially for in-line pH measurements in bio-processes where CIP and SIP are used. This rugged gel-filled electrode leads the industry for fast and precise measurements, even after repeated autoclaving or sterilization cycles at 140 °C (284 °F). The electrode utilizes METTLER TOLEDO's silver-ion trap, keeping the reference junction clear even in the presence of sulfide-bearing solutions. With the InPro 3100 (i) UD, upside-down mounting is possible.

### Specifications

pH range	0–14 pH	
Temperature	InPro 3100 (i):	0 to 80 °C (32 to 176 °F) for operation 0 to 140 °C (32 to 284 °F) for sterilization
	InPro 3100 (i) UD:	0 to 80 °C (32 to 176 °F) for operation 0 to 130 °C (32 to 266 °F) for sterilization
Operating pressure	0 to 6 barg @ 140 °C (0 to 87 psig @ 284 °F)	
Cable connection	ISM: K8S; Analog: VP	
Process connection	Pg 13.5 thread	
Reference system	Argentinal with silver-ion trap	
Type of junction	Ceramic junction	
Reference electrolyte	Gel	
Lengths	120 mm, 150 mm, 225 mm, 325 mm, 425 mm	
Shaft diameter	12 mm	
Temperature sensor	ISM: Digital;	
	Analog: Pt 100 or Pt 1000	
Sterilizable	Yes	
Autoclavable	Yes	
pH membrane	High alkali glass (HA)	

**Certificates and Approvals** METTLER TOLEDO Quality Certificate, Pressure Equipment Directive guidelines (PED) 97/23/EC, ATEX: Ex ia IIC T6/T5/T4/T3 Ga/Gb, FM: IS Cl. I, II, III, Div 1, GR ABCDEFG/T6

### Intelligent Sensor Management (ISM)

pH electrodes with integrated ISM functionality allow Plug and Measure and advanced diagnostics. ISM simplifies the installation, handling and maintenance of measurement equipment. For more information see ISM introduction pages 10–11.

### Features Overview

- Fully autoclavable or sterilizable in-situ
- Gel electrolyte reduces maintenance
- Resistant to poisoning substances
- EHEDC certified
- Pressure resistant up to 6 barg (87 psig)
- Watertight connector (IP68)
- Integral temperature sensor permits automatic temperature compensation

► [www.mt.com/InPro3100](http://www.mt.com/InPro3100)

## Ordering Information

ISM Electrodes	Length	Temp. Signal	Order Number
InPro 3100i/SG	120 mm	Digital	52 003 515
InPro 3100i/SG	150 mm	Digital	52 003 516
InPro 3100i/SG	225 mm	Digital	52 003 517
InPro 3100i/SG	325 mm	Digital	30 090 877
InPro 3100i/SG	425 mm	Digital	30 091 063
InPro 3100iUD	120 mm	Digital	52 005 433
InPro 3100iUD	225 mm	Digital	52 003 583
Analog Electrodes			
InPro 3100	120 mm	Pt 100	52 000 656
InPro 3100	120 mm	Pt 1000	52 000 658
InPro 3100UD	120 mm	Pt 100	52 002 531
InPro 3100UD	120 mm	Pt 1000	52 002 752
InPro 3100	150 mm	Pt 100	52 000 659
InPro 3100	150 mm	Pt 1000	52 000 660
InPro 3100	225 mm	Pt 100	52 000 661
InPro 3100	225 mm	Pt 1000	52 000 662
InPro 3100UD	225 mm	Pt 100	52 005 354
InPro 3100	325 mm	Pt 100	52 000 663
InPro 3100	325 mm	Pt 1000	52 000 664
InPro 3100	425 mm	Pt 100	52 000 665
InPro 3100	425 mm	Pt 1000	52 000 666



### Did You Know

All pH electrodes, even those with gel or solid polymer reference systems, contain a liquid electrolyte in the pH half cell which must be in contact with the internal silver wire in order for the sensor to measure accurately.

Sensors therefore must be installed at least 15° from horizontal to prevent air bubble interference. Exception: the InPro 3100 (i) UD “upside-down” electrode.

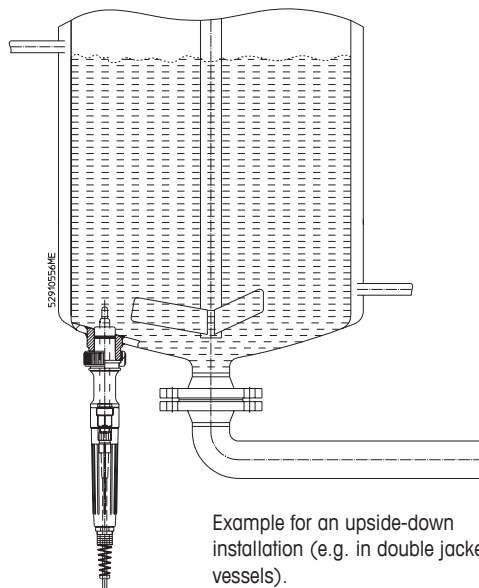

### Suitable Housings

	p.
InFit 761 e .....	110
InFit 762 e .....	112
InDip .....	113
InTrac 777 e .....	119
InTrac 797 e .....	120
InTrac 781 .....	121
InTrac 785/787 .....	122

# InPro 3250 (i) Highest Performance, Highest Accuracy



InPro 3253

InPro 3250i

### Features Overview

- Fully autoclavable or sterilizable in-situ (InPro 3250 (i), InPro 3253 (i))
- Pressurized electrolyte reduces maintenance
- MaxCert™, including biocompatibility according to USP 26, Chapter 87

The InPro 3250 (i) family is a pre-pressurized, liquid-filled, low-maintenance pH sensor and temperature sensor for in-line measurements in demanding applications. Its durable design is well suited for harsh chemical process conditions or to meet the stringent demands of sterile biotech applications where CIP and SIP are used. These rugged electrodes lead the industry for fast and precise measurements, even after repeated autoclaving or sterilization cycles at 140 °C (284 °F). The InPro 3250 (i) family is available with an expanded selection of different pH-sensitive glass membranes. This guarantees the best possible measurement performance under the most diverse operating conditions, both in chemical and biotech processes. The platinum-auxiliary electrode (solution ground) which functions to eliminate ground loop problems, allows for use of advanced sensor diagnostics, or can be used as an ORP (redox) sensor. Also available with Intelligent Sensor Management (ISM) for Plug and Measure and advanced diagnostics.

### Specifications

pH range	0 – 14 pH InPro 3250 (i); 0 – 12 pH InPro 3253 (i); 1 – 11 pH InPro 3251 (i), InPro 3252
Temperature	0 to 100 °C (32 to 212 °F) InPro 3250 (i), InPro 3253 (i); –25 to 80 °C (–13 to 176 °F) InPro 3251 (i); 0 to 80 °C (32 to 176 °F) InPro 3252
Operating pressure	0 to 4 barg (0 to 58 psig)
Cable connection	ISM: K8S; Analog: VP
Process connection	Pg 13.5 thread
Reference system	Argenthal with silver-ion trap
Type of junction	Ceramic junction
Reference electrolyte	Pre-pressurized liquid
Lengths	120 mm, 225 mm, 325 mm, 425 mm
Shaft diameter	12 mm
Temperature sensor	ISM: digital Analog: Pt 100 or Pt 1000
Sterilizable	Yes, up to 140 °C (284 °F)
Autoclavable	Yes
pH membrane	Various by applications
<b>Certificates and Approvals</b>	METTLER TOLEDO Quality Certificate, Pressure Equipment Directive guidelines (PED) 97/23/EC, ATEX: Ex ia IIC T6/T5/T4/T3 Ga/Gb, FM: IS Cl. I, II, III, Div 1, GR ABCDEFG/T6

### Intelligent Sensor Management (ISM)

pH electrodes with integrated ISM functionality allow Plug and Measure and advanced diagnostics. ISM simplifies the installation, handling and maintenance of measurement equipment. For more information see ISM introduction pages 10–11.



**Ordering Information**

<b>ISM Electrodes</b>	<b>Length</b>	<b>Temp. Signal</b>	<b>Order Number</b>		
<b>– with alkali resistant glass</b>					
InPro 3250i/SG	120mm	Digital	52 005 373		
InPro 3250i/SG	225mm	Digital	52 005 374		
InPro 3250i/SG	325mm	Digital	52 005 375		
InPro 3250i/SG	425mm	Digital	52 005 376		
<b>– for applications at low temperatures</b>					
InPro 3251 i/SG	120mm	Digital	52 003 693		
<b>– with steam sterilizable glass</b>					
InPro 3253i/SG	120mm	Digital	52 005 377		
InPro 3253i/SG	225mm	Digital	52 005 378		
InPro 3253i/SG	325mm	Digital	52 005 379		
InPro 3253i/SG	425mm	Digital	52 005 380		
<b>Analog Electrodes</b>	<b>Length</b>	<b>Temp. Signal</b>	<b>Order Number</b>	<b>Temp. Signal</b>	<b>Order Number</b>
<b>– with alkali resistant glass</b>					
InPro 3250	120mm	Pt 100	52 002 547	Pt1000	52 002 548
InPro 3250	225mm	Pt 100	52 002 552	Pt1000	52 002 553
InPro 3250	325mm	Pt 100	52 002 554	Pt1000	52 002 555
InPro 3250	425mm	Pt 100	52 002 556	Pt1000	52 002 557
InPro 3250 SG	120mm	Pt 100	52 002 558	Pt1000	52 002 559
InPro 3250 SG	225mm	Pt 100	52 002 560	Pt1000	52 002 561
InPro 3250 SG	325mm	Pt 100	52 002 562	Pt1000	52 002 563
InPro 3250 SG	425mm	Pt 100	52 002 564	Pt1000	52 002 565
<b>– for applications at low temperatures</b>					
InPro 3251	120mm	Pt 100	52 002 585	–	–
InPro 3251	225mm	Pt 100	52 002 586	–	–
<b>– for applications in hydrofluoric acid cont. media</b>					
InPro 3252	120mm	Pt 100	52 002 587	–	–
InPro 3252	225mm	Pt 100	52 002 588	–	–
InPro 3252	250mm	Pt 100	52 002 589	–	–
<b>– with steam sterilizable glass</b>					
InPro 3253	120mm	Pt 100	52 002 566	Pt1000	52 002 567
InPro 3253	225mm	Pt 100	52 002 568	Pt1000	52 002 569
InPro 3253	250mm	Pt 100	52 002 570	–	–
InPro 3253	325mm	Pt 100	52 002 571	Pt1000	52 002 572
InPro 3253	425mm	Pt 100	52 002 573	Pt1000	52 002 574
InPro 3253 SG	120mm	Pt 100	52 002 576	Pt1000	52 002 577
InPro 3253 SG	225mm	Pt 100	52 002 578	Pt1000	52 002 579
InPro 3253 SG	325mm	Pt 100	52 002 580	Pt1000	52 002 581
InPro 3253 SG	425mm	Pt 100	52 002 582	Pt1000	52 002 583

**InPro Sensor Designation**

The last digit of the InPro designation indicates the

pH glass type:

00: High alkali glass (HA)

01: Low temperature glass (LoT)

02: Hydrofluoric acid resistant glass (HF)

03: Steam sterilizable glass (A41)

**Suitable Housings****p.**

InFit 761 e .....	110
InFit 762 e .....	112
InFlow .....	114
InDip .....	113
InTrac 777 e .....	119
InTrac 797 e .....	120
InTrac 781 .....	121
InTrac 785/787 .....	122



# InPro 3300

## The Non-Glass Solution



The InPro 3300 is a solid-state, non-glass pH sensor utilizing Ion Selective Field Effect Transistor (ISFET) technology. The unbreakable design eliminates the risk of broken glass, making this sensor ideally suited for the food and beverage industry. Combining the ISFET with Ingold’s Argenthal reference system, this sensor is designed to provide accurate results after repeated sterilization cycles. The use of on-line pH measurement allows for automated process control, and eliminates costly and time consuming grab sample analysis.

### Specifications

pH range	0–14 pH (retract during CIP)
Temperature	0 to 80 °C (32 to 176 °F)
Operating pressure	0 to 5 barg @ 80 °C (0 to 72 psig @ 176 °F)
Cable connection	VP
Process connection	Pg 13.5 thread
Reference system	Gel electrolyte, Argenthal
Type of junction	Ceramic junction
Lengths	120 mm, 225 mm, 325 mm
Shaft diameter	12 mm
Temperature sensor	Pt 1000
Sterilizable	Yes, up to 130 °C (266 °F)
Autoclavable	Yes
pH membrane	ISFET (solid state), requires ±3VDC

**Certificates and Approvals** METTLER TOLEDO Quality Certificate, Quality certificate, Pressure Equipment Directive guidelines (PED) 97/23/EC

### Ordering Information

Product Description	Length	Order Number
InPro 3300/Pt1000	120 mm	52 002 253
InPro 3300/Pt1000	225 mm	52 002 496
InPro 3300/Pt1000	325 mm	52 002 497
M700 ISFET option*		52 121 274

\* Only for transmitter M700

For pH buffers, refer to “pH and Redox Accessories” section.

For cables, cable lengths and for terminating connectors, refer to “Cables” section on pages 132–135.

### Features Overview

- Non-glass ISFET design – ensures process safety by eliminating possibility of broken glass
- Sterilizable to 130 °C (266 °F)
- Gel electrolyte results in extended operational life and reduced maintenance costs

Suitable Housings	p.
InFit 761 e.....	110
InTrac 777 e.....	119
InTrac 797 e.....	120
InTrac 781 .....	121

▶ [www.mt.com/InPro3300](http://www.mt.com/InPro3300)

# InPro 4010

## With Solid Polymer Electrolyte



The InPro 4010 is a low maintenance, economical pH sensor targeted towards industrial wastewater processes. Available with an internal temperature sensor which provides accurate temperature reading and compensation in a single unit. The solid polymer electrolyte is in direct contact with the sample medium, eliminating potential for junction fouling. The plastic body makes this a rugged sensor with reliable performance in contaminated liquids.

### Specifications

pH range	2 – 12 pH
Temperature	0 to 60 °C (32 to 140 °F)
Operating pressure	1 barg at 60 °C (15 psig @ 140 °F)
Cable connection	VP
Process connection	Pg 13.5 thread
Reference system	Argenthal
Type of junction	Open aperture, double junction
Reference electrolyte	Solid polymer
Lengths	120 mm
Shaft diameter	12 mm
Temperature sensor	Pt 100, Pt 1000 or none
Sterilizable	No
Autoclavable	No
pH membrane	General purpose glass
<b>Certificates and Approvals</b>	METTLER TOLEDO Quality Certificate

### Ordering Information

pH Electrodes	Length	Temperature Sensor	Order Number
InPro 4010	120 mm	Pt 100	52 000 511
InPro 4010	120 mm	Pt 1000	52 000 512
InPro 4010	120 mm	None	52 000 510

For pH buffers, refer to “pH and Redox Accessories” section.

For cables, cable lengths and for terminating connectors, refer to “Cables” section on pages 132 – 135.

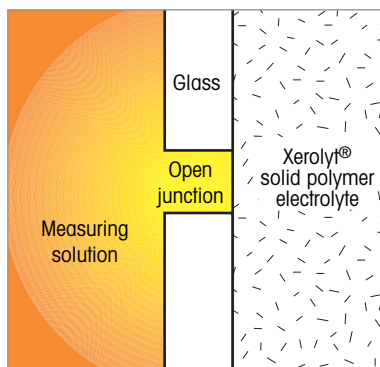

Open reference junction

### Features Overview

- Open aperture junction resists fouling
- Solid polymer electrolyte requires no refilling, reduces maintenance
- Double junction reference design resists poisoning
- VarioPin Connector – IP 68, Easy connection, excellent signal transmission
- Integral temperature sensor permits automatic temperature compensation
- Plastic body prevents breakage

Suitable Housings	p.
InFit 761e .....	110
InFit 762e .....	112
InFlow .....	114
InDip .....	113
InTrac 777 e .....	119
InTrac 785/787 .....	122

► [www.mt.com/InPro4010](http://www.mt.com/InPro4010)

## InPro 4260 (i)/InPro 4281 i Reliable, Long-lasting Electrodes

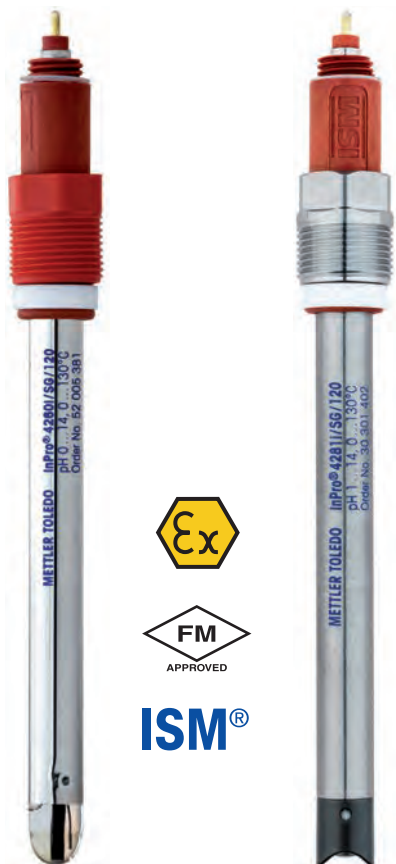

InPro 4260i

InPro 4281i

The InPro 4260 (i)/InPro 4281 i is a combined pH electrode and temperature sensor family designed for highly demanding chemical applications. InPro 4260 (i)/InPro 4281 i electrodes feature Xerolyt® Extra polymer reference electrolyte for precise pH measurement and longer lifetime, even under the most difficult industrial environments. Also available with Intelligent Sensor Management (ISM) for Plug and Measure and advanced diagnostics.

### Specifications

pH range	0–14 pH InPro 4260 (i); 1–14 pH InPro 4261 (i), InPro 4281 (i)
Temperature	InPro 4260 (i), InPro 4281 i: 0 to 130°C (32 to 266°F) InPro 4262 (i): 0 to 80°C (32 to 176°F)
Operating pressure	15 barg @ 25 °C, 7 barg @ 130 °C (0 to 217 psig @ 77 °F, 101 psig @ 266 °F)
Cable connection	ISM: K8S; Analog: VP
Process connection	Pg 13.5 thread
Reference system	Argenthal
Type of junction	Open junction with direct contact to media
Reference electrolyte	Xerolyt® Extra
Lengths	120 mm, 225 mm, 425 mm
Shaft diameter	12 mm
Shaft materials	InPro 426x (i): Glass; InPro 428x i: Titanium
Temperature sensor	ISM: Digital; Analog: Pt100 or Pt1000
Sterilizable	No
Autoclavable	No
pH membrane	Various by applications
Solution ground	InPro 426x (i): Platinum; InPro 428x i: Titanium
<b>Certificates and Approvals</b>	METTLER TOLEDO Quality Certificate, Pressure Equipment Directive guidelines (PED) 97/23/EC, ATEX: Ex ia IIC T6/T5/T4/T3 Ga/Gb, FM: IS Cl. I, II, III, Div 1, GR ABCDEFG/T6 EN 10204-3.1 (InPro 4281 i)

### Intelligent Sensor Management (ISM)

pH electrodes with integrated ISM functionality allow Plug and Measure and advanced diagnostics. ISM simplifies the installation, handling and maintenance of measurement equipment. For more information see ISM introduction pages 10–11.

### Features Overview

- Xerolyt polymer electrolyte
- Open junction eliminates clogging
- Resistant to poisoning substances
- Expanded pH range covers 0–14 pH
- Resistant to solvents, strong acids and alkali
- Domed glass membrane impedes bubble formation for greater reliability
- Watertight connector (IP68), integral temperature sensor
- ATEX and FM certified for hazardous areas
- InPro 4281 i electrode is made with a rugged titanium shaft, providing exceptional chemical resistance and durability.
- InPro 4281 i features a flat pH membrane suited for fibers and high solids samples

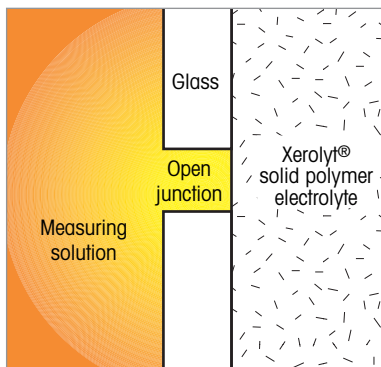

Open reference junction

► [www.mt.com/InPro4260](http://www.mt.com/InPro4260)

## Ordering Information

ISM Electrodes	Length	Temp. Signal	Order Number
InPro 4260 i/SG	120 mm	Digital	52 005 381
InPro 4260 i/SG	225 mm	Digital	52 005 382
InPro 4260 i/SG	425 mm	Digital	52 005 407
InPro 4262 i/SG	120 mm	Digital	30 018 467
InPro 4262 i/SG	225 mm	Digital	30 018 468
InPro 4281 i/SG	120 mm	Digital	30 301 402
InPro 4281 i/SG	225 mm	Digital	30 301 403
InPro 4281 i/SG	425 mm	Digital	30 301 404
<b>Analog Electrodes</b>			
InPro 4260	120 mm	Pt 100	52 002 986
InPro 4260	120 mm	Pt 1000	52 002 987
InPro 4260	225 mm	Pt 100	52 002 988
InPro 4260	225 mm	Pt 1000	52 002 989
InPro 4260	425 mm	Pt 100	52 002 992
InPro 4260	425 mm	Pt 1000	52 002 993
InPro 4260SG	120 mm	Pt 100	52 003 545
InPro 4260SG	120 mm	Pt 1000	52 003 546
InPro 4260SG	225 mm	Pt 100	52 003 547
InPro 4260SG	225 mm	Pt 1000	52 003 548
InPro 4262	120 mm	Pt 100	52 003 549
InPro 4262	120 mm	Pt 1000	52 003 550
InPro 4262	225 mm	Pt 100	52 003 551
InPro 4262	225 mm	Pt 1000	52 003 552
InPro 4262	425 mm	Pt 100	52 003 553
InPro 4262	425 mm	Pt 1000	52 003 554



### Did You Know

The InPro 4260 (i) family now also includes a hydrofluoric acid resistant glass formulation. Solution ground stabilizes the high impedance pH signal and provides an additional reference point for sensor diagnostics which can detect changes in performance due to influence of the media.



### InPro Sensor Designation

The last digit of the InPro designation indicates the pH glass type:

- 00 – High alkali glass (HA)
- 01 – Low temperature glass (LoT)
- 02 – Hydrofluoric acid resistant glass (HF)
- 03 – Steam sterilizable glass (A41)

Suitable Housings	p.
InFit 761 e.....	110
InFit 762 e.....	112
InFlow .....	114
InDip .....	113
InTrac 777 e.....	119
InTrac 797 e.....	120
InTrac 781 .....	121
InTrac 785/787 .....	122

# InPro 4550/InPro 4501

## The Rugged Solution



InPro 4550

InPro 4501 VP

The InPro 4550/4501 are rugged, low maintenance, combination pH/temperature sensors, designed to handle harsh chemical processes and industrial wastewater applications. The durable polymer body houses a solid polymer reference electrolyte, making the electrode robust from both physical and chemical attack. A solution ground prevents ground loop problems and allows advanced sensor diagnostics. The solid polymer electrolyte is in direct contact with the sample medium, eliminating potential for junction fouling. The InPro 4501's flat glass pH membrane is protected against breakage and is self-cleaning in flowing applications. The higher pressure/temperature specifications of the InPro 4550 target demanding applications with heavily contaminated media and aggressive industrial chemicals.

### Specifications

	InPro 4550	InPro 4501
pH range	0–14 pH	1–14 pH
Temperature	0 to 130 °C (32 to 266 °F)	0 to 100 °C (32 to 212 °F)
Operating pressure	0 to 7 barg @ 130 °C (0 to 101 psig @ 266 °F)	0 to 6 barg @ 65 °C (0 to 87 psig @ 149 °F)
Cable connection	VP	VP or fixed cable
Process connection	1" MNPT	1" MNPT
Reference system	Argenthal	Argenthal
Type of junction	Open aperture, double junction	Open aperture, double junction
Reference electrolyte	Xerolyt Extra, solid polymer	Xerolyt Extra, solid polymer
Solution ground	Titanium	Titanium
Immersion length	72.5 mm (from front threads)	72.5 mm (from front threads)
Process connection	1" MNPT, 2-places	1" MNPT, 2-places
Temperature sensor	Pt 100, Pt 1000	Pt 100, Pt 1000
Body material	PPS (polyphenylene sulfide)	PVDF
Sterilizable	No	No
Autoclavable	No	No
pH membrane	High alkali glass (HA)	Flat membrane with low temperature glass (LoT)

Certificates and Approvals	METTLER TOLEDO Qual. Cert., Pressure Equipment Directive guidelines (PED) 97/23/EC, ATEX: Ex ia IIC T6/T5/T4/T3 Ga/Gb, FM: IS Cl. I, II, III, Div 1, GR ABCDEFG/T6	METTLER TOLEDO Qual. Cert.
----------------------------	--	----------------------------

### Features Overview

- Withstands high process temperature and pressure (InPro 4550)
- PPS body is highly resistant to chemical attack (InPro 4550)
- Open aperture junction resists fouling
- Solid polymer electrolyte requires no refilling, reduces maintenance
- Watertight connector (IP 68) for easy connection and excellent signal transmission
- Dual NPT threads allow direct mounting into process
- Solution ground allows sensor diagnostics and eliminates ground loop problems

▶ [www.mt.com/InPro4550](http://www.mt.com/InPro4550)  
▶ [www.mt.com/InPro4501](http://www.mt.com/InPro4501)

**Ordering Information**

Electrode	Connection	Cable Length	Temperature Sensor	Order Number
<b>InPro 4550</b>				
InPro 4550	VarioPin	N/A	Pt100	52 002 401
InPro 4550	VarioPin	N/A	Pt1000	52 002 402
<b>InPro 4501</b>				
InPro 4501	VarioPin	N/A	Pt100	59 909 570
InPro 4501	VarioPin	N/A	Pt1000	59 909 571
InPro 4501	Fixed cable	3m (9.8ft)	Pt100	59 909 542
InPro 4501	Fixed cable	3m (9.8ft)	Pt1000	59 909 545
InPro 4501	Fixed cable w/BNC	3m (9.8ft)	Pt100	59 909 543
InPro 4501	Fixed cable	10m (32.8ft)	Pt100	59 909 546
InPro 4501	Fixed cable	10m (32.8ft)	Pt1000	59 909 548
<b>Accessory</b>				
Protective sleeve				52 401 808

For pH buffers, refer to "pH and Redox Accessories" section.

For cables, cable lengths and for terminating connectors, refer to "Cables" section on pages 132–135.



**Did You Know**

The protective sleeve for the InPro 4550 and InPro 4501

keeps the connection clean in dirty environments and protects the cable from stress.



Slotted tip protects the pH glass membrane



Flat glass pH membrane and solution ground

<b>Suitable Housings</b>	<b>p.</b>
InDip 550 .....	113

## InPro 4800 (i)/InPro 4881 i For Harsh Environments



InPro 4800 i



InPro 4881 i

The InPro 4800 (i)/InPro 4881 i is the top-of-the-line combined pH and temperature electrode family designed to handle high-temperature and high-pressure dirty chemical applications. The strong resistance to oxidizing media, solvents, acid and alkali solutions make it suitable for highly demanding industrial applications including chemical processing, chlor-alkali, pulp and paper, dyes and pigments, and sugar processing.

Also available with Intelligent Sensor Management (ISM) for Plug and Measure and advanced diagnostics.

### Specifications

pH range	0 – 14 pH InPro 4800 (i); 1 – 14 pH InPro 4801 (i), InPro4881 i 1 – 11 pH InPro 4802 (i)
Temperature	InPro 4800 (i), InPro 4801 (i), InPro 4881 i: – 5 to 130 °C (23 to 266 °F) InPro 4802 (i): 0 to 80 °C (32 to 176 °F)
Operating pressure	12 barg @ 130 °C (174 psig @ 266 °F)
Cable connection	ISM: K8S; Analog: VP
Process connection	Pg 13.5 thread
Reference system	Ag / AgCl system, pressure-compensated double gel-electrolyte chambers
Type of junction	Exterior: PTFE annular diaphragm Interior: Non-flow ceramic diaphragm
Reference electrolyte	Gel
Lengths	120 mm, 225 mm, 425 mm
Shaft diameter	12 mm
Shaft materials	InPro 480x (i): Glass InPro 488x i: Titanium
Temperature sensor	ISM: Digital; Analog: Pt 100 or Pt 1000
pH membrane	Various by applications
Solution ground	InPro 480x (i): Platinum InPro 488x i: Titanium
Sterilizable	No
Autoclavable	No
Solution ground	Platinum
Glass membrane	InPro 4800: Cylindrical, high alkali quality glass InPro 4801 SG, InPro 4881 i: Flat, low impedance quality glass

**Certificates and Approvals** METTLER TOLEDO Quality Certificate  
Pressure Equipment Directive guidelines (PED) 97/23/EC,  
ATEX: Ex ia IIC T6/T5/T4/T3 Ga/Gb,  
FM: IS Cl. I, II, III, Div 1, GR ABCDEFG/T6  
EN 10204-3.1 (InPro 4281 i)

### Intelligent Sensor Management (ISM)

pH electrodes with integrated ISM functionality allow Plug and Measure and advanced diagnostics. ISM simplifies the installation, handling and maintenance of measurement equipment. For more information see ISM introduction pages 10–11.

▶ [www.mt.com/InPro4800](http://www.mt.com/InPro4800)



## Ordering Information

ISM Electrodes	Length	Temp. Signal	Order Number
InPro 4800 i/SG	120 mm	Digital	52 005 383
InPro 4800 i/SG	225 mm	Digital	52 005 384
InPro 4800 i/SG	425 mm	Digital	52 003 748
InPro 4801 i/SG	120 mm	Digital	52 003 581
InPro 4801 i/SG	225 mm	Digital	52 069 539
InPro 4801 i/SG	425 mm	Digital	52 003 857
InPro 4802 i/SG	120 mm	Digital	52 003 696
InPro 4802 i/SG	225 mm	Digital	52 003 697
InPro 4881 i/SG	120 mm	Digital	30 301 405
InPro 4881 i/SG	225 mm	Digital	30 301 406
InPro 4881 i/SG	425 mm	Digital	30 301 407

## Analog Electrodes

InPro 4800	120 mm	Pt 100	52 002 124
InPro 4800	120 mm	Pt 1000	52 002 125
InPro 4800 SG	120 mm	Pt 100	52 003 541
InPro 4800 SG	120 mm	Pt 1000	52 003 542
InPro 4800	225 mm	Pt 100	52 002 126
InPro 4800	225 mm	Pt 1000	52 002 127
InPro 4800 SG	225 mm	Pt 100	52 003 543
InPro 4800 SG	225 mm	Pt 1000	52 003 544
InPro 4800	425 mm	Pt 100	52 002 129
InPro 4800	425 mm	Pt 1000	52 002 130
InPro 4801 SG	120 mm	Pt 100	52 002 131
InPro 4801 SG	120 mm	Pt 1000	52 002 132
InPro 4802	225 mm	Pt 100	52 002 718
InPro 4802 SG	225 mm	Pt 1000	52 003 398

## Features Overview

- High pressure/high temperature rating 12 barg @ 130 °C (174 psig @ 266 °F)
- Very long diffusion path using two electrolyte chambers
- PTFE annular junction repels dirt
- Resistant to strong oxidizing agents, solvents, acids and alkali, and to poisoning substances
- Watertight connector (IP 68), integral temperature sensor
- InPro 4801 (i) and InPro 4881 i feature a flat pH membrane suited for fibers and high solids samples
- ATEX and FM certified for hazardous areas
- InPro 4881 i electrode is made with a rugged titanium shaft, providing exceptional chemical resistance and durability.



## InPro Sensor Designation

The last digit of the InPro designation indicates the pH glass type:

- 00 – High alkali glass (HA)
- 01 – Low temperature glass (LoT)
- 02 – Hydrofluoric acid resistant glass (HF)
- 03 – Steam sterilizable glass (A41)



## Quick Tip

A combination pH electrode should never be stored dry as this will dehydrate the electrode. Also, do not store an electrode in deionized water, rather, soak the electrode in the pH buffer or electrolyte recommended in the electrode manual.



## Did You Know

The InPro 4801 (i) SG electrode features a unique flat glass membrane ideal for applications with high fiber or solid concentrations.

## Suitable Housings

	p.
InFit 761 e .....	110
InFit 762 e .....	112
InFlow .....	114
InDip .....	113
InTrac 777 e .....	119
InTrac 781 .....	121
InTrac 785/787 .....	122

# InPro 4850 i

## For the Toughest Chlor-Alkali Processes

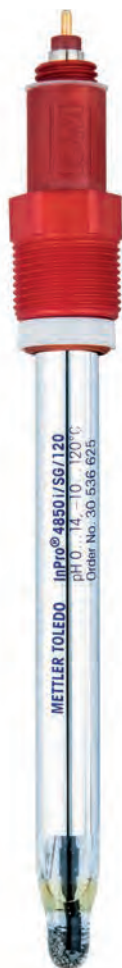

InPro 4850 i is a combination pH electrode featuring a sodium membrane glass that uses the sodium concentration in the process (brine) as a reference. The difference in electrical potential between the pH-glass and the sodium reference glass is converted into the pH value. The sodium reference system is highly resistant to chlorine and other oxidizing agents. This makes the sensor very well suited for the demanding process conditions in chlor-alkali production. Solution ground and shielding eliminate interference, and enable redox measurement. Digital signal conversion ensures 100% signal integrity and stability. Intelligent Sensor Management (ISM) technology simplifies sensor handling and reduces sensor lifecycle costs.

### Specifications

pH range	0 – 14 pH
Temperature	– 10 to 120 °C (14 to 248 °F)
Operating pressure	0 to 12 barg @120 °C (0 to 174 psig @ 248 °F)
Cable connection	ISM: K8S
Process connection	Pg 13.5 thread
Reference system	Sodium sensitive glass membrane
Type of junction	None
Lengths	120 mm, 225 mm
Shaft diameter	12 mm
Temperature sensor	Digital
Sterilizable	No
Autoclavable	No
pH membrane	High alkali glass (HA)
Min. Na+ concentration	10 mg/L when pH > 7; 100 mg/L when 7 > pH > 2; 1 g/L when pH < 2
Storage solution	Storage solution buffer pH = 4.01/Na 3.9 M (P/N 52 004 103)

**Certificates and Approvals** METTLER TOLEDO Quality Certificate, Pressure Equipment Directive guidelines (PED) 97/23/EC ATEX: Ex ia IIC T6/T5/T4/T3 Ga/Gb, FM: IS Cl. I, II, III, Div 1, GR ABCDEFG/T6

### Intelligent Sensor Management (ISM)

pH electrodes with integrated ISM functionality allow Plug and Measure and advanced diagnostics. ISM simplifies the installation, handling and maintenance of measurement equipment. For more information see ISM introduction pages 10–11.

InPro 4850 i requires a near stable sodium concentration for the best measurement results. A 10% difference in brine concentration leads to 0.05 pH error.

### Features Overview

- Hermetically sealed reference system resistant to any effects from poisoning substances such as chlorine.
- Very high resistance to oxidizing media, solvents, and acid or alkali solutions.
- Reliable operation in processes with particularly high pressures and high temperatures.
- Platinum solution ground (SG) electrode enables redox (ORP) measurement and advanced sensor diagnostics, as well as preventing measurement errors due to ground potentials.

▶ [www.mt.com/InPro4850](http://www.mt.com/InPro4850)

### Ordering Information

pH Electrodes	Length	Order Number
InPro 4850i/SG	120mm	30 536 625
InPro 4850i/SG	225mm	30 536 627

pH Buffers	Order Number	Order Number
Designation	1 × 250 ml	6 × 250 ml
pH 2.00, 3.9M NaCl	52 004 100	52 004 101
pH 4.01, 3.9M NaCl	52 004 103	52 004 104
pH 7.00, 3.9M NaCl	52 004 106	52 004 107
pH 9.21, 3.9M NaCl	52 004 109	52 004 110

Redox Buffers	Order Number	Order Number
Designation	1 × 250 ml	6 × 250 ml
Redox buffer 320mV, 3.9M NaCl	30 104 917	–

### AK9 Coax Cables (–25 °C to 70 °C / –13 to 158 °F)

Designation	Connector	Cable Length	Order Number
AK9	open	1 m (3.3ft)	59 902 167
AK9	open	3 m (9.8ft)	59 902 193
AK9	open	5 m (16.4ft)	59 902 213
AK9	open	10m (32.8ft)	59 902 230
AK9	open	20m (65.6ft)	52 300 204

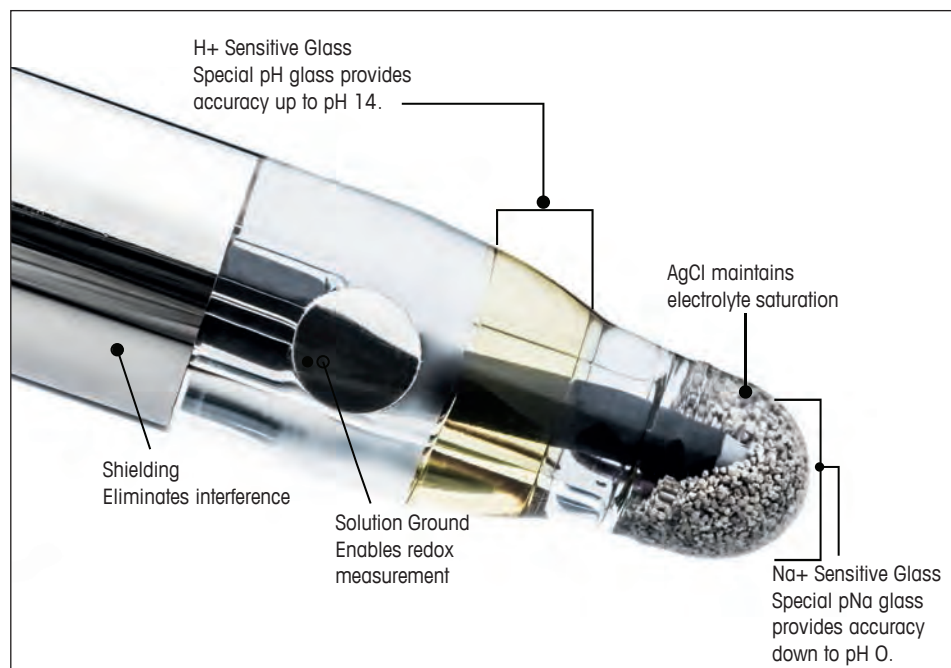

**Did You Know**  
 InPro 4850i is the unique dual-membrane pH sensor with ISM digital signal for resisting chlorine and other oxidizing solutions.

Suitable Housings	p.
InFit 761 e.....	110
InFit 762 e/763 e.....	112
InFlow 751 .....	114
InTrac 787 .....	122



# Puncture pH Electrodes For Cheese and Meat Products



Puncture pH electrodes are specially designed for quick, accurate pH measurement in meat, sausage, cheese, and fruit. The rugged needle-shaped sensing membrane penetrates directly into the medium, without requiring time-consuming sample preparation. The solid polymer reference system eliminates clogging by fats and proteins using an open junction design. The non-refillable reference electrolyte reduces maintenance to a minimum.

### Specifications

pH range	2 – 11 pH
Temperature	0 to 80 °C (32 to 176 °F)
Response time	< 20 s (98 % between pH 4 to 7)
Materials of construction	Glass/PBT (shaft)
Membrane resistance	< 250 MΩ (25 °C/77 °F)
Type of membrane glass	LoT
Temperature sensor	None
Diaphragm	One open aperture junction
Reference system	Argenthal system
Reference electrolyte	Xerolyt Extra solid polymer
Cable and connections	S7-type
Shaft dimensions	Length: 25 mm Diameter: 6 mm
Sterilizable	No
Autoclavable	No

**Certificates and Approvals** METTLER TOLEDO Quality Certificate

### Ordering Information

Product Description	Order Number
Puncture electrode, polymer electrolyte	59 903 311
Puncture knife	59 900 386
Puncture electrode with knife	59 900 388
Cable, 1 m (3.3 ft), DIN connector for 1120/1140 meter	59 902 243
Cable, 1 m (3.3 ft), BNC connector	59 902 246
Cable, 1 m (3.3 ft), stripped ends	59 902 245
Buffer pouch, pH 4.01, pkt. of 30	51 302 069
Buffer pouch, pH 7.00, pkt. of 30	51 302 047
Buffer pouch, pH 9.21, pkt. of 30	51 302 070

### Features Overview

- Specially designed for direct pH measurement in cheese and meat
- Plastic shaft is FDA listed PBT
- Open aperture junction resists fouling
- Solid polymer electrolyte requires no refilling, reduces maintenance
- Optional puncture knife available for particularly hard cheeses and meats
- Use with 1120/1140 portable pH meter



### Did You Know

The pH measurement in cheese, meat, and fruit provides valuable information on product freshness and quality.

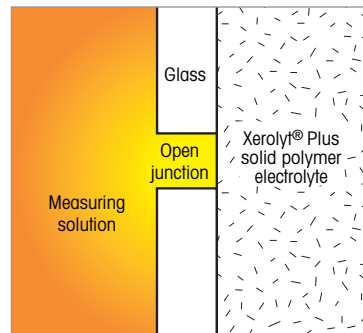

Open reference junction

# pH Buffers, Electrolytes, Cleaning and Storage Solutions

## Optimal Solutions for Your Process Analytics System



METTLER TOLEDO offers a wide selection of accessories to facilitate ease of use and maintenance of high accuracy pH measurement systems. These include buffers for pH calibration, electrolyte solutions for reference electrodes, and pH sensor simulators for evaluating measurement loops. Below is a partial listing of product accessories available for pH and redox systems.

### Ordering Information

<b>pH and Redox Buffers</b>	<b>Volume</b>	<b>Order Number</b>
<b>pH buffers</b>		
pH 4.01 buffer	250ml	51 340 057
pH 7.00 buffer	250ml	51 340 059
pH 9.21 buffer	250ml	51 300 193
pH 10.00 buffer	250ml	51 340 056
pH 2.00 buffer w/3.9M NaCl	250ml	52 004 100
pH 4.01 buffer w/3.9M NaCl	250ml	52 004 103
pH 7.00 buffer w/3.9M NaCl	250ml	52 004 106
pH 9.21 buffer w/3.9M NaCl	250ml	52 004 109
<b>Redox buffers</b>		
Redox buffer 220mV	6 × 250 ml	51 340 081
Redox buffer 468mV	6 × 30 ml	51 319 058
Redox buffer 320mV, w/3.9M NaCl	1 × 250 ml	30 104 917

### Reference Electrolyte Solutions

<b>for Liquid-filled Electrodes</b>	<b>Volume</b>	<b>Order Number</b>
Friscolyt B	250ml	51 340 053
Viscolyt	250ml	51 340 235
3M KCl	250ml	51 340 049

### Cleaning/Storage Solutions

	<b>Volume</b>	<b>Order Number</b>
pH electrode cleaner / proteins	250ml	51 340 068
Reactivating solution	6 × 30 ml	51 319 053
Storage solution, 3M KCl	250ml	51 340 049
Ceramic diaphragm cleaner	250ml	51 340 070



### Did You Know

The primary cause of pH measurement problems is a dirty ceramic diaphragm. Ingold has a complete line of pH cleaning solutions, as well as buffers and electrolyte to keep your electrode functioning properly.

## Pro2Go Portable pH/ORP Meter

Simple, Robust and Mobile



### Features Overview

- Supports analog, puncture and ISM sensors
- ISM diagnostics
- Calibration timer alerts when calibration is due
- Rugged housing for industrial use

### Other Highlights

- Measures pH, ORP and temperature
- IP67 rated housing
- Weatherproof USB interface for data exchange

For periodic pH or redox measurements, a mobile meter is the ideal choice. Designed for laboratory and industrial applications. The intuitive menu on Pro2Go™ ensures out-of-the-box operation for anyone. The meter's ergonomic design allows one-handed operation for both big and small hands. Its light weight makes measurement easy and convenient, even over lengthy periods of repeated measurement.

Pro2Go is compatible with both analog and digital ISM sensors. Its ISM features include Plug and Measure for error-free setup, and display of sensor diagnostics including DLI, ACT and TTM, so operators know when sensor calibration or replacement will be required.

The Pro2Go includes a datalogger that stores up to 2000 measurement data sets and computer interface for easy collection of data from the field.

### Specifications

Measurement parameters	pH, mV and temperature
Sensor type	Analog and ISM sensors
pH measuring range	–2.00 to +20.00 pH
mV range	–2000 to +2000 mV
Temperature input	NTC30K
Temperature measuring range	ATC: –5 to 130 °C (+23 to 266 °F) MTC: –30 to 130 °C (–22 to 266 °F)
Predefined buffer groups	9
Automatic buffer recognition	Yes
Calibration	1-point (offset), 2-point (slope and offset)
Supply voltage batteries	4 × LR6/AA 1.5 V Alkaline or 4 × HR6/AA 1.2 V NiMH rechargeable
Battery life (standby)	200 to 250 hrs
Supply voltage (USB powered)	Connection: Micro-USB Rating: 5 V DC, 100 mA
User interface	Graphic LC Display
Languages	10 (English, German, French, Italian, Spanish, Portuguese, Russian, Chinese, Korean and Japanese)
PC connection	Micro-USB for Data transfer and power
Memory size	2000 datasets (GLP conform)
Dimensions	Height × Width × Depth: 222 × 70 × 35 mm (8.74 × 2.76 × 1.38 inch)
Weight	0.29 kg (0.64 lb)
Material	• Housing: ABS/PC reinforced • Window: Polymethylmethacrylate (PMMA)
Enclosure rating	IP 67
Range of application	For indoor and outdoor use
Approvals	CAN/CSA-C22.2 No. 61010-1-12 UL Std. No. 61010-1 (3rd Edition)

► [www.mt.com/Pro2Go](http://www.mt.com/Pro2Go)

**Ordering Information**

<b>Pro2Go portable pH Meter</b>	<b>Order Number</b>
Pro2Go portable pH Meter including USB cable, sensor cable AK9-BNC/RCA for ISM sensors, rubber holster, wrist strap, CD with documentation and software, Declaration of conformity, Test certificate	30 386 271
<b>Accessories</b>	
Rubber holster	30 487 344
USB cable for PC connection	30 487 345
Power adapter for USB cable (to operate instrument without batteries)	30 487 346
Sensor cable AK9-BNC/RCA for ISM sensors	30 487 466
EasyDirect pH PC software	free download
<b>pH Buffer Solutions</b>	
Buffer pouch pH 4.01 (pkt. of 30)	51 302 069
Buffer pouch pH 7.00 (pkt. of 30)	51 302 047
Buffer pouch pH 9.21 (pkt. of 30)	51 302 070



Data transfer via USB interface.



**Did You Know**

You can get fast and simple data transfer with EasyDirect pH software via USB interface

# Dissolved Oxygen Measurement Systems

## High Reliability and Wide Application Coverage

**Real-time, continuous measurement of dissolved oxygen (DO) is central to the efficiency of many industrial processes. METTLER TOLEDO offers a range of robust DO sensors that utilize a well-established electrochemical measuring principle, plus sensors with the latest optical technology for applications where simplicity of operation is particularly important.**

### Measurement of dissolved oxygen

Proper oxygen levels are important in many processes in biotechnology, pharmaceutical development, food and beverage, chemical manufacturing, and in water and primary waste treatment. Control of dissolved oxygen helps ensure product quality, reduce costs, and provide maximum product yield.

### Optical measurement solutions from METTLER TOLEDO

The heart of the optical sensor is an oxygen-sensitive layer containing immobilized marker molecules. They absorb light from a light emitting diode and are able to release this energy as light at a different wavelength (fluorescence).

The fluorescence depends on the amount of oxygen that is present in the environment of the marker molecules. This effect allows determination of the oxygen concentration in the sample media.

### Advantages of optical oxygen technology

The optical oxygen sensors offer a highly accurate oxygen measurement with enhanced signal stability and fast response time. The sensors are fully steam sterilizable, autoclavable and fulfill all industrial requirements for hygienic design and traceability. Since no electrolyte exchange or sensor polarization is needed, sensor main-

tenance is easy and less error-prone. This sensor type takes advantage of ISM technology.

### Electrochemical oxygen sensors

The large portfolio of Ingold amperometric sensors fulfill the highest industrial requirements in performance and design to accommodate virtually any application. They are equipped with the unique ISM technology.

ISM®



InPro 6860 i



InPro 6960 i  
InPro 6970 i



InPro 6900 i  
InPro 6950 i



InPro 6800  
12 mm and 25 mm



## Application guide for dissolved oxygen sensors

	Amperometric hygienic sensors		Optical hygienic sensors				Non hygienic sensors	
	InPro 6800	InPro 6850i	InPro 6900/InPro 6900i	InPro 6860i nA/InPro 6860i mA HART (MODBUS)	InPro 6960i	InPro 6970i	InPro 6050	Optical InTap
<b>Industrial processes</b>								
<b>Pharmaceutical Industry</b>								
Biotechnological applications	•	•	•					
<b>Chemical Industry</b>	•	•						
<b>Beverage Industry</b>	•	•	•		•	•		•
<b>Wastewater applications</b>							•	

### Transmitter selection

Several Ingold transmitters are available to work in conjunction with our amperometric and optical sensors including the multi-parameter transmitter lines M100, M200, M300, M400, M700 and M800.

### Housings and socket selection

The widest selection of stationary, retractable and submersion housings is provided to match virtually any

process connection. Vessel ports or sockets are used as entry points for the oxygen sensor. METTLER TOLEDO provides a host of ports including the original Ingold 25 mm port which is recognized as a standard in the biotech and pharmaceutical industries.

### Professional service and validation

Sensor service includes rebuilding, cleaning, testing, and recertification of your Ingold sensor, done quickly and

efficiently to minimize downtime.

Validation and testing of oxygen equipment is done with equipment traceable to NIST.

### Integration flexibility

Optical sensors can be integrated directly using their analog (mA-HART) or digital (MODBUS) interface.

## InPro 6860 i Optical Oxygen Sensor

### Easy Handling, Exceptional Performance

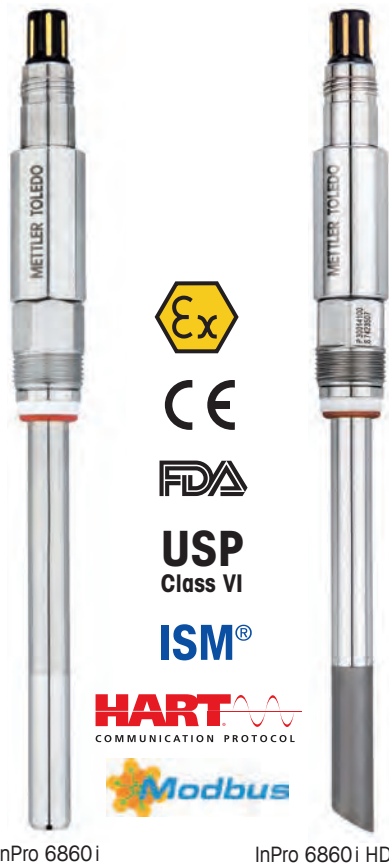

InPro 6860 i

InPro 6860 i HD

#### Features Overview

- Plug and Measure
- Outstandingly fast service
- Immediate availability without need of polarization
- No electrolyte handling
- Low detection limit
- Highest signal stability
- Fast response time
- All wetted parts in accordance to FDA and USP Class VI-standards
- Sterilizable and autoclavable
- Hygienically polished surface
- Digital ISM technology

Combining innovative ISM technology with high-end optical measurement, METTLER TOLEDO offers optical oxygen sensors fully suitable for biopharma applications. The InPro 6860 i offers highly accurate oxygen measurement with enhanced stability, and easy handling without electrolyte change or time-consuming polarization procedures. The sensor is equipped with a digital interface (digital ISM and Modbus RTU) plus analog output signal for direct integration into existing biocontrollers, analog transmitters and into process environments including HART communication protocol.

#### Integrates ISM technology

With ISM, the installation, maintenance, and safety of the system is drastically improved. All sensor relevant data are stored in the sensor. Pre-calibrated systems transfer the data automatically to the transmitter and are therefore ready for measuring within seconds. Changes in the measuring system are monitored via the Dynamic Lifetime Indicator. With these features, error-free and safe operation of the sensor and the transmitter is assured. For more information see ISM introduction pages 10–11.

#### Specifications

##### Performance

Operating range	0 ppb to saturation
Accuracy	$\leq \pm [1\% + 8 \text{ ppb}]$
Response time at 25 °C (77 °F) (Air → N <sub>2</sub> )	98% of final value in <90s

##### Construction

Measuring principle	Fluorescence quenching
Cable connection	VP8
Connector design	Straight
Process connection	Pg 13.5
Sensor body	316 L stainless steel
OptoCap membrane material	PTFE
Surface roughness of wetted parts	N5 / R <sub>a</sub> 16 (R <sub>a</sub> =0.4 μm / 16 μin)
O-ring material	EPDM (FDA positive listed)
Sensor diameter	12 mm

##### Working Conditions

Temperature compensation	Automatic
Measuring temperature range	5 to 60 °C (41 to 140 °F)
Environmental temperature range	InPro 6860 i: –20 to 140 °C (–4 to 284 °F) (sterilizable, autoclavable)

Operating pressure	0.2 to 6 bar (2.9 to 87 psi absolute)
--------------------	---------------------------------------

Design pressure	Maximum 6 bar (87 psi absolute)
-----------------	---------------------------------

##### Certificates and Approvals

METTLER TOLEDO Quality Certificate  
 FDA/USP Class VI, 3.1, N5/R<sub>a</sub>16  
 ATEX

### Ordering Information

Sensor	Length	nA	mA; HART	Modbus	OptoCap BT02T	OptoCap BT02THD	Order Number
InPro 6860 i nA	120 mm	•		•	•		30 014 100
InPro 6860 i nA	220 mm	•		•	•		30 014 101
InPro 6860 i nA	320 mm	•		•	•		30 014 102
InPro 6860 i nA	420 mm	•		•	•		30 014 103
InPro 6860 i nA HD	120 mm	•		•		•	30 449 703
InPro 6860 i nA HD	220 mm	•		•		•	30 449 704
InPro 6860 i nA HD	320 mm	•		•		•	30 526 901
InPro 6860 i nA HD	420 mm	•		•		•	30 526 902
InPro 6860 i nA HD	590 mm	•		•		•	30 526 903
InPro 6860 i mA	120 mm		•	•	•		30 129 734
InPro 6860 i mA	220 mm		•	•	•		30 129 735
InPro 6860 i mA	320 mm		•	•	•		30 129 736
InPro 6860 i mA	420 mm		•	•	•		30 129 737
InPro 6860 i mA HD	120 mm		•	•		•	30 449 705
InPro 6860 i mA HD	220 mm		•	•		•	30 449 706
InPro 6860 i mA HD	320 mm		•	•		•	30 526 900
InPro 6860 i mA HD	420 mm		•	•		•	30 532 157

Transmitter	Order Number
M400 Type 2	30 374 112
M400 Type 3	30 374 113
M400/2H	30 025 514
M400/2(X)H	30 025 515
M400 FF	30 026 616
M400 FF 4-wire	30 374 121
M400 PA	30 026 617
M800 Process, 1-channel	30 026 633
M800 Process, 2-channel	52 121 813
M800 Process, 4-channel	52 121 853
M800 Process, 1-channel SST	30 246 551
M800 Process, 2-channel SST	30 246 552
M800 Process, 4-channel SST	30 246 553

InPro 6860 i Consumables	Order Number
OptoCap BT02T (InPro 6860 i)	30 018 857
OptoCap BT02THD	30 302 172

Accessories	Order Number
iLink Multi (incl. automated humidity and pressure compensation)	30 130 631
iLink Multi Cable/Set oDO (Cable set for all oDO sensors)	30 355 582
Housing Retrofit kit	52 403 811
Power supply in case of need for analog installation of InPro 6860 i	30 014 119

### OptoCap replacement



OptoCap – BT02T electropolished, delivers a hygienically polished surface.

OptoCap – BT02THD stabilizes the measurement signal by its hydrophilic surface by avoiding air bubble interference.



#### Did You Know

The optical oxygen sensors can be used in conjunction with all M400 and M800 transmitters as well as with existing analog and digital MODBUS installations.



#### Did You Know

Oxygen bubble interference can be a common issue when optical oxygen sensors are installed vertically. The new OptoCap™ (BT02THD) with its proprietary design has a surface treatment that efficiently reduces these interferences. This allows greater production control leading to consistent yield, batch to batch.

Suitable Housings	p.
InFit 761 e.....	110
InTrac 777 e.....	119
InTrac 797 e.....	120
InTrac 781 .....	121
InTrac 785 e.....	122

## Powering Accessories for InPro 6860 i Digital Sensor Integration

Combined oDO & pH Junction Box with Bluetooth connectivity



InPro 6860 i  
Adapter T82



InPro 6860 i  
Adapter VP6

### Features Overview

- Uses existing cables to biocontrollers
- Simplified installation
- Flexible powering options

The J-Box BTLE simplifies biocontroller upgrades to advanced InPro 6860 i optical oxygen and digital ISM pH sensors without complicated wiring or grounding requirements. Using a shared power supply, the J-Box BTLE connects both oxygen and pH sensors to biocontrollers using existing and standard T-82 (for oxygen) and AK9 (for pH) cables. Measurement signals are sent from the J-Box as nA for oxygen and mV for pH providing universal connectivity to biocontrollers. Standard 1 or 3 meter cables are available for connection from the J-Box BTLE to the oxygen and pH sensors.

The J-Box BTLE is equipped with a Bluetooth interface. It connects to iSense and iSense Mobile for calibration, maintenance and diagnostic purposes.

The InPro 6860 i Adapter provides functionality with a direct connection to InPro 6860 i optical oxygen sensors. 24 V DC is provided through a standard 2.1 mm × 5.5 mm female barrel connection with existing T-82 cables connected to the adapter's outlet.

### Flexible installation choices

The J-Box BTLE is ideal for installing ISM optical oxygen and pH sensors onto the head plate of a reactor when space is limited.

The InPro 6860 i Powered Adapter is ideal for installations with sufficient space on the head plate of a reactor and where only optical oxygen is required.

### Specifications

#### Performance

Minimum input power requirement	24 V DC (min. 800 mW, 0.03 A)
Power connection	2.5 mm × 5.5 mm male barrel mating to a 2.1 mm × 5.5 mm female barrel connection

#### Combined J-Box Sensor Connections

To InPro 6860 i sensor	Male VarioPin
To ISM pH sensor	Male BNC
Simulated O <sub>2</sub> (nA) to biocontroller	Male T-82 connector* wired for temperature
Simulated pH (mV) to biocontroller	Male K9/K8S

#### InPro 6860 i Adapter Connections

To InPro 6860 i sensor	Female VarioPin
To biocontroller	Male T-82 connector wired for temperature

\* The T-82 Adapter is also available with a VP6 connector.

## Details

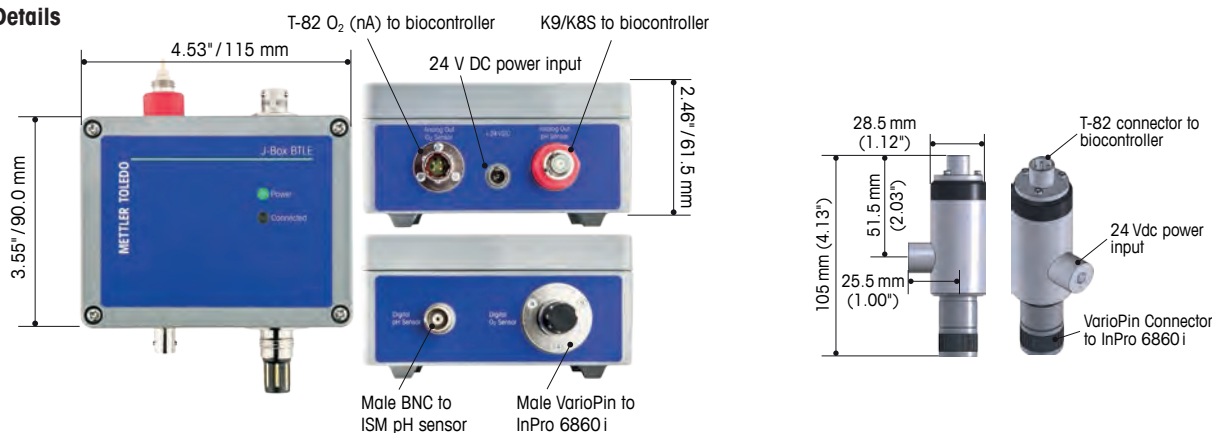

## Ordering Information

Product Description	Order Number
J-Box BTLE	30 365 368
InPro 6860i T-82 Adapter for Biocontroller Retrofit	30 083 984
InPro 6860i VP6 Adapter for Biocontroller Retrofit	30 083 985
Power supply 24 V 0.75 A angled plug	30 323 961

### O<sub>2</sub> Accessory Cables (for J-Box BTLE to InPro 6860i sensor)

Product Description	Order Number
Cable, VP-8, 1 m, Female VP	30 094 370
Cable, VP-8, 3 m, Female VP	30 094 371

### ISM pH Accessory Cables (for J-Box BTLE to ISM pH sensor)

Product Description	Order Number
Cable, AK9, 1 m, Female BNC	59 902 168
Cable, AK9, 3 m, Female BNC	59 902 194

### Biocontroller Retrofit Cables for InPro 6860 i

VP6 (analog)	Order Number	VP8 (digital)	Order Number
All standard VP6 (analog)	see table, pp. 132/133	VP8-ST, 1 m (3.3 ft)	52 300 353
VP6 Connector BNC, 1 m (3.3 ft)	30 032 730	VP8-ST, 3 m (9.9 ft)	52 300 354
VP6 Connector BNC, 3 m (9.9 ft)	30 032 731	VP8-ST, 5 m (16.4 ft)	52 300 355
VP6 Connector LEMO, 1 m (3.3 ft)	30 032 732	VP8-ST, 10 m (32.8 ft)	52 300 356
VP6 Connector LEMO, 3 m (9.9 ft)	30 032 733	VP8-ST, 15 m (49.2 ft)	52 300 357
VP6 Connector Lumberg, 1 m (3.3 ft)	30 032 734	VP8-ST, 20 m (65.6 ft)	52 300 358
VP6 Connector Lumberg, 3 m (9.9 ft)	30 032 735	VP8-ST, 35 m (114.8 ft)	52 300 359



### Did You Know

The J-Box BTLE is an ideal solution to retrofit biocontrollers with InPro 6860i and ISM pH sensors. The integral 2.5 mm × 5.5 mm barrel connector enables simplified power connection. METTLER TOLEDO recommends using a three-pronged grounded 24 V DC power supply for best performance.



### Additional Cable Options

METTLER TOLEDO offers a wide variety of oxygen and pH cables for connecting the J-Box BTLE or InPro 6860i Adapter to your biocontrollers. Please contact your local representative to learn more about our available options.

## InPro 6960 i/InPro 6970 i Optical Oxygen Sensor

### Reliable and Intelligent



#### Features Overview

- Plug and Measure
- Fast maintenance in less than 1 minute
- Immediate availability, no need for polarization
- No electrolyte handling
- Low detection limit
- Highest signal stability
- Fast response time
- All wetted parts in accordance to FDA and USP Class VI-standards
- Fully CIP and SIP resistant
- Hygienically polished surface finish of N5/R<sub>a</sub>16 (R<sub>a</sub>=0.4 μm/16 μin)
- Digital ISM technology

Optical technology in 12 mm design is available for challenging brewery applications such as filler line measurement. These optical sensors offer high performance together with reduced and easier maintenance. The outstanding measurement performance with low detection limit, minimum drift and short response time improves oxygen monitoring and helps to reduce out of spec production. The easy maintenance without liquid handling and polarization increases the availability of the measuring system.

#### ISM

ISM technology helps to make optical oxygen measurement simple and more reliable. Thanks to the Dynamic Lifetime Indicator (DLI) and Adaptive Calibration Timer (ACT), maintenance planning becomes easy and the risk of sensor failures during production time is significantly reduced. For more information see ISM introduction pages 10–11.

#### Specifications

##### Performance

Operating range	InPro 6960 i: 0 ppb to 25 ppm
	InPro 6970 i: 0 ppb to 2000 ppb

Accuracy	InPro 6960 i: $\leq \pm [1 \% + 8 \text{ ppb}]$
	InPro 6970 i: $\leq \pm [1 \% + 2 \text{ ppb}]$

Response time at 25 °C (77 °F) (Air → N <sub>2</sub> )	98 % of final value in <20 s
--	------------------------------

Residual signal in oxygen-free medium	<0.025 % of the signal in ambient air
---------------------------------------	---------------------------------------

##### Construction

Measuring principle	Fluorescence quenching
---------------------	------------------------

Cable connection	5-Pin
------------------	-------

Connector design	Straight
------------------	----------

Process connection	Pg 13.5
--------------------	---------

Sensor body	316 L stainless steel
-------------	-----------------------

Membrane material	Silicone
-------------------	----------

Surface roughness of wetted parts	N5/R <sub>a</sub> 16 (R <sub>a</sub> =0.4 μm/16 μin)
-----------------------------------	--

O-ring material	EPDM (FDA positive listed)
-----------------	----------------------------

Sensor diameter	12 mm
-----------------	-------

##### Working Conditions

Temperature compensation	Automatic
--------------------------	-----------

Measuring temperature range	–5 to 40 °C (23 to 104 °F)
-----------------------------	----------------------------

Environmental temperature range	0 to 121 °C (32 to 250 °F) (sterilizable)
---------------------------------	---

Operating pressure	0.2 to 12 bar (2.9 to 174 psi absolute)
--------------------	---

Design pressure	Maximum 12 bar (174 psi absolute)
-----------------	-----------------------------------

##### Certificates and Approvals

METTLER TOLEDO Quality Certificate,  
FDA/USP Class VI, 3.1, N5/R<sub>a</sub>16

► [www.mt.com/InPro6960i](http://www.mt.com/InPro6960i)

► [www.mt.com/InPro6970i](http://www.mt.com/InPro6970i)

**Ordering Information****12 mm InPro 6960 i/6970 i**

Sensor	Length	Order Number
InPro 6960 i	120 mm	52 206 500
InPro 6960 i	220 mm	52 206 501
InPro 6960 i	320 mm	52 206 502
InPro 6970 i	120 mm	52 206 393
InPro 6970 i	220 mm	52 206 394
InPro 6970 i	320 mm	52 206 395

**Transmitter**

M400 Type 3	30 374 113
M400/2H	30 025 514
M400/2(X)H	30 025 515
M400 FF	30 026 616
M400 PA	30 026 617
M800 SST, 1-channel	30 246 551
M800 SST, 2-channel	30 246 552
M800 Process, 1-channel	30 026 633
M800 Process, 2-channel	52 121 813
M800 Process, 4-channel	52 121 853

**InPro 6960 i/6970 i Consumables**

OptoCap BW01 for 6960 i	52 206 509
OptoCap BR01 for 6970 i	52 206 403
O-ring set	52 206 252

**Sensor Cables**

2 m (6.6 ft)	52 300 379
5 m (16.4 ft)	52 300 380
10 m (32.8 ft)	52 300 381
15 m (49.2 ft)	52 206 422

**Accessories**

iLink-RS485 Sensor Cable for iSense	52 300 399
iLink Multi	30 130 631
iLink Multi cable set oDO	30 355 582
Housing retrofit kit	52 403 811
Maintenance cap	52 206 251

**Did You Know**

In conjunction with the M400, the **InPro 6960 i** offers an easy-to-use solution for high ppm measurements as found in wort aeration monitoring.

**Other Highlights**

- No electrolyte necessary
- No polarization required
- Easy maintenance

**Did You Know**

In conjunction with the M400, the **InPro 6970 i** offers an easy-to-use solution for low ppb measurements throughout brewing and filler lines.

**OptoCap replacement**

One piece O-ring-free OptoCap

**Suitable Housings**

InFit 761 e.....	110
InTrac 777 e.....	119
InTrac 797 e.....	120

## InPro 6800/InPro 6850 i (12 & 25 mm) For Accurate Oxygen Measurement



InPro 6850 i    InPro 6800

### Features Overview

- Revolutionary “Quick Disconnect” system allows for service in seconds
- Defection limit down to 6 ppb
- Accurate measurement and quick response
- Long lasting and easy to maintain membranes
- FDA positive listed materials of construction
- Hygienically polished surface finish of N5/R<sub>a</sub>16 (R<sub>a</sub>=0.4 μm/16 μin)
- EHEDG certified for cleanability and 3A compliant
- Wetted O-rings comply with FDA and USP Class VI standards
- Autoclavable and steam sterilizable

The InPro 6800 dissolved oxygen sensor with 12 or 25 mm diameter body provides maximum accuracy and ultimate cleanability for vessels with limited space or in containers with smaller volumes. The sensor is available with the state-of-the-art VP connector or T-82 connector in straight or angled versions. A durable 316L stainless steel construction allows for CIP, steam sterilization or autoclaving in place, and the high sensor finish virtually eliminates contamination of the process. Ingold’s PTFE/silicone membranes have been designed with an internal steel mesh that makes the membrane more rugged and dramatically increases membrane life.

### Specifications

#### Performance

Operating range	6 ppb to saturation
Accuracy	≤ ± [1 % +6 ppb]
Response time at 25 °C (77 °F)	98 % of final value in < 90 s
Sensor signal in air at 25 °C (77 °F)	50 to 110 nA
Residual signal in oxygen-free medium	< 0.1 % of the signal in ambient air

#### Construction

Measuring principle	Amperometric Clark electrode
Cable connection	Analog VarioPin (IP 68), Digital K8S (IP 68)
Connector design	Straight or angled
Process connection	Pg 13.5 (12 mm); Ingold (25 mm)
Sensor body	316L stainless steel
Membrane material	PTFE/Silicone/PTFE (reinforced with steel mesh)
Surface roughness of wetted parts	N5/R <sub>a</sub> 16 (R <sub>a</sub> =0.4 μm/16 μin)
O-ring material	Silicone (FDA and USP Class VI positive listed)
Sensor diameter	12 mm/25 mm

#### Working Conditions

Temperature compensation	Automatic
Measuring temperature range	0 to 80 °C (32 to 176 °F)
Environmental temperature range	–5 to 140 °C (23 to 284 °F) (steriliz., autocl.)
Operating pressure	0.2 to 6 bar (2.9 to 87 psi absolute)
Design pressure	Maximum 12 bar (174 psi absolute)

#### Certificates and Approvals

	METTLER TOLEDO Quality Certificate, EHEDG, FDA/USP Class VI, 3.1, N5/R <sub>a</sub> 16,
	ATEX: Ex ia IIC T6/T5/T4/T3 Ga/Gb,
	Ex ia IIIC T69 °C/T81 °C/T109 °C/T161 °C Da/Db
	FM: IS Cl. I, II, III, Div 1, GR ABCDEFG/T6

#### Intelligent Sensor Management (ISM)

InPro 6850i sensors with integrated ISM functionality allow Plug and Measure and advanced diagnostics. ISM simplifies the installation, handling and maintenance of measurement equipment. For more information see ISM introduction pages 10–11.

#### Other Highlights

- Small 12 or 25 mm diameter saves valuable space
- Pg 13.5 threads for interface into housings
- Comes with either watertight VP connector (IP 68) or T-82 connector
- Ingold 25 mm sensor design recognized as a standard in the industry
- Cap nut allows for easy interface to Ingold ports

► [www.mt.com/InPro6800](http://www.mt.com/InPro6800)



## Ordering Information

### 12 mm InPro 6800/6850 i DO Sensor Series

Sensor	Length	Connector	VP Number	ISM Number
InPro 6800/6850 i	70 mm	Straight	52 200 964	52 206 118
InPro 6800/6850 i	120 mm	Straight	52 200 965	52 206 119
InPro 6800/6850 i	220 mm	Straight	52 200 966	52 206 120
InPro 6800/6850 i	320 mm	Straight	52 200 967	52 206 121
InPro 6800/6850 i	420 mm	Straight	52 200 968	52 206 122
InPro 6810	70 mm	Angled	52 200 969	
InPro 6810	120 mm	Angled	52 200 970	
InPro 6810	220 mm	Angled	52 200 971	
InPro 6810	420 mm	Angled	52 200 973	

### 12 mm InPro 6800 DO Sensor Series (T-82 Connector)

Sensor	Length	Connector	Order Number
InPro 6820	120 mm	Straight T-82	52 201 012
InPro 6820	220 mm	Straight T-82	52 201 013
InPro 6820	320 mm	Straight T-82	52 201 014
InPro 6820	420 mm	Straight T-82	52 201 015
InPro 6830	120 mm	Angled T-82	52 201 016
InPro 6830	220 mm	Angled T-82	52 201 017
InPro 6830	320 mm	Angled T-82	52 201 018
InPro 6830	420 mm	Angled T-82	52 201 019

### 25 mm InPro 6800/6850 i DO Sensor Series

Sensor	Length	Connector	VP Number	ISM Number
InPro 6800/6850 i	80 mm	Straight	52 200 974	52 206 123
InPro 6800/6850 i	160 mm	Straight	52 200 975	52 206 124
InPro 6800/6850 i	260 mm	Straight	52 200 976	52 206 125
InPro 6800/6850 i	360 mm	Straight	52 200 977	52 206 126
InPro 6810	80 mm	Angled	52 200 978	
InPro 6810	100 mm	Angled	52 200 982	
for B. Braun ports	EPDM O-rings			
InPro 6810	160 mm	Angled	52 200 979	
InPro 6810	260 mm	Angled	52 200 980	
InPro 6810	360 mm	Angled	52 200 981	

For available sensors for B. Braun ports please ask your local sales organization.

### 25 mm InPro 6800 DO Sensor Series (T-82 Connector)

Sensor	Length	Connector	Order Number
InPro 6820	80 mm	Straight T-82	52 201 020
InPro 6820	160 mm	Straight T-82	52 201 021
InPro 6820	260 mm	Straight T-82	52 201 022
InPro 6830	80 mm	Angled T-82	52 201 023
InPro 6830	160 mm	Angled T-82	52 201 024
InPro 6830	260 mm	Angled T-82	52 201 025

### InPro 6800/6850 i Consumables

	Order Number
Membrane body, single T-96	52 200 071
Membrane kit T-96 (4 membranes, 1 O-ring set silicone, 25 ml of electrolyte, wetted parts SS 316L)	52 200 024
Membrane bodies (16 pieces), T-96	52 206 114
O <sub>2</sub> electrolyte pack (3 × 25 mL)	30 298 424
InPro 6800 replacement anode/cathode assembly	52 200 899
InPro 6850i replacement anode/cathode assembly	52 206 347

For accessories, cables and cable lengths refer to page 132 – 135.

InPro 6800 sensor master with sensor

Angled version of InPro 6800



Replaceable anode/cathode assembly



### Did You Know

The dissolved oxygen membrane used on these sensors is more durable and less prone to fouling than competitive products due to its advanced membrane design. This makes these sensors an excellent choice for dirty DO applications.

### Suitable Housings for 12 mm p.

InFit 761 e.....	110
InFit 762 e/763 e.....	112
InFlow .....	114
InDip .....	113
InTrac 777 e.....	119
InTrac 797 e.....	120
InTrac 781 .....	121
InTrac 785/787 .....	122

## InPro 6900 (i)/InPro 6950 i Accurate Trace Oxygen Measurement



Angled version also available

**USP**  
Class VI



**ISM**<sup>®</sup>

InPro 6950 i    InPro 6900

### Features Overview

- Revolutionary “Quick Disconnect” system allows for service in seconds
- Accurate measurement at very low levels of oxygen
- Long lasting and easy to maintain membranes
- FDA positive listed materials of construction
- Hygienically polished surface finish of N5/R<sub>a</sub>16 (R<sub>a</sub>=0.4 μm / 16 μin)
- EHEDG certified for cleanability and 3-A compliant
- Wetted O-rings comply with FDA and USP Class VI standards
- Steam sterilizable

► [www.mt.com/InPro6950](http://www.mt.com/InPro6950)

► [www.mt.com/InPro6900](http://www.mt.com/InPro6900)

The InPro 6900 and the InPro 6950 dissolved oxygen sensors with 12 mm diameter body offer the same advanced features as the InPro 6800, with the additional benefit of being able to measure trace oxygen concentrations. In particular, the InPro 6950 i sensor offers excellent accuracy at the lowest oxygen levels due to the built-in 4-electrode measurement system. Ingold’s unique cathode design, membrane and specially formulated electrolyte generate stable and accurate results at extremely low levels of oxygen.

### Specifications

#### Performance

Operating range	<b>InPro 6900 (i):</b> 1 ppb to saturation in aqueous solutions 3 ppb to saturation in CO <sub>2</sub> containing solutions
	<b>InPro 6950 i:</b> 0.1 ppb to saturation in aqueous solutions 0.25 ppb to saturation in CO <sub>2</sub> containing solutions

Accuracy	<b>InPro 6900 (i):</b> ≤ ± [1 % + 1 ppb] / ≤ ± [1 % + 3 ppb]
	<b>InPro 6950 i:</b> ≤ ± [1 % + 0.1 ppb] / ≤ ± [1 % + 0.25 ppb]

Response time at 25 °C (77 °F)	<b>InPro 6900 (i):</b> 98 % of final value in <90 s
	<b>InPro 6950 i:</b> 90 % of final value in <90 s

Sensor signal in air at 25 °C (77 °F)	<b>InPro 6900 (i):</b> 250 to 500 nA
	<b>InPro 6950 i:</b> 2500 to 6000 nA

Residual signal in oxygen-free medium	<b>InPro 6900 (i):</b> <0.03 % of the signal in ambient air
	<b>InPro 6950 i:</b> <0.025 % of the signal in ambient air

#### Construction

Measuring principle	Amperometric Clark electrode
Sensor design	12 mm sensor with VP design
Connector design	Straight or angled
Process connection	Pg 13.5
Sensor body	316L stainless steel
Membrane material	PTFE/Silicone (reinforced)
Surface roughness of wetted parts	N5/R <sub>a</sub> 16 (R <sub>a</sub> =0.4 μm / 16 μin)
O-ring material	Silicone (FDA and USP Class VI positive listed)

#### Working Conditions

Temperature compensation	Automatic
Measuring temperature range	0 to 80 °C (32 to 176 °F)
Environmental temperature range	<b>InPro 6900 (i):</b> –5 to 140 °C (23 to 284 °F) (sterilizable and autoclavable)
	<b>InPro 6950 i:</b> –5 to 121 °C (23 to 250 °F) (sterilizable)

Operating pressure	<b>InPro 6900 (i):</b> 0.2 to 6 bar (2.9 to 87 psi absolute) 0.2 to 9 bar (2.9 to 130 psi absolute) with T-6900 R
	<b>InPro 6950 i:</b> 0.2 to 9 bar (2.9 to 130 psi absolute)

Design pressure	Maximum 12 bar (174 psi absolute)
-----------------	-----------------------------------

#### Certificates and Approvals

METTLER TOLEDO Quality Certificate, EHEDG, FDA/USP Class VI, 3.1, N5/Ra16, ATEX: Ex ia IIC T6/T5/T4/T3 Ga/Gb, Ex ia IIIC T69 °C/T81 °C/T109 °C/T161 °C Da/Db FM: IS Cl. I, II, III, Div 1, GR ABCDEFG/T6
--

#### Intelligent Sensor Management (ISM)

Intelligent Sensor Management (ISM) InPro 6900 i and 6950 i sensors with integrated ISM functionality allow Plug and Measure and advanced diagnostics. ISM simplifies the installation, handling and maintenance of measurement equipment. For more information see ISM introduction pages 10–11.



## Ordering Information

### 12 mm InPro 6900 (i) DO Sensor Series

Sensor	Length	Connector Style	VP Order Number	ISM Order Number
InPro 6900 (i)	70 mm	Straight	52 200 944	52 206 316
InPro 6900 (i)	120 mm	Straight	52 200 945	52 206 317
InPro 6900 (i)	220 mm	Straight	52 200 946	52 206 318

### 12 mm InPro 6950 i DO Sensors

Sensor	Length	Connector Style	ISM Order Number
InPro 6950 i	70 mm	Straight	52 206 127
InPro 6950 i	120 mm	Straight	52 206 128
InPro 6950 i	220 mm	Straight	52 206 129
InPro 6950 i	320 mm	Straight	52 206 130

### InPro 6900 (i) Consumables

	Order Number
Membrane body, single InPro 6900 (i)	52 201 049
Membrane kit InPro 6900 (i)	52 201 003
(4 membranes, 1 O-ring set silicone, 10 ml of electrolyte, wetted parts SS 316L)	
Reinforced membrane body, single InPro 6900 (i) (T-6900 R)	52 201 108
Reinforced membrane kit InPro 6900 (i) (T-6900 R)	52 201 109
(4 membranes, 1 O-ring set silicone, 10 ml of electrolyte, wetted parts SS 316L)	
InPro 6900 electrolyte pack (3 × 5 mL)	30 298 425
InPro 6900 (i) replacement anode/cathode assembly	52 200 943

### InPro 6950 (i) Consumables

	Order Number
Membrane kit InPro 6950 i	52 206 106
(4 membranes, 1 O-ring set silicone, 10 ml of electrolyte, wetted parts SS 316L)	
InPro 6950 electrolyte pack (3 × 5 mL)	30 298 426
InPro 6950 i replacement anode/cathode assembly	52 206 112

For accessories and spare parts refer to p. 53.

Replaceable anode/cathode assembly for InPro 6950



Reinforced membrane body InPro 6900

## Other Highlights

- Small 12 mm diameter saves valuable space
- Watertight VP connector (IP68)
- Variety of sensor lengths available
- Withstands CIP

## InPro 6900 (i)/InPro 6950 i Transmitter Compatibility

Sensor	M400 Type 3	M700 (x) Modules		M800 2/4-ch	M800 1-ch
		4700 i	4700 i x trace		
InPro 6900	•	•	•	–	•
InPro 6900 i	•	•	•	•	•
InPro 6950	–	•	•	–	•
InPro 6950 i	•	•	•	•	•

## Suitable Housings

	p.
InFit 761 e.....	110
InFit 762 e/763 e.....	112
InFlow .....	114
InDip .....	113
InTrac 777 e.....	119
InTrac 797 e.....	120
InTrac 781 .....	121
InTrac 787 .....	122

## InTap: Portable Optical Dissolved Oxygen Analyzer Maximum Control of Beverage Quality



Dissolved oxygen level is an important quality factor in the food and beverage industry. Maintaining low oxygen levels in food and beverage production ensures flavor stability as well as long shelf life. The InTap, with an internal optical DO sensor, allows users to measure dissolved oxygen values wherever and whenever required for optimum control of production processes and product quality.

The InTap is used for the measurement of beverage DO, and at-line measurement of beer during or after filtration and prior to filling. Further, the InTap is the perfect reference measurement instrument for calibrating installed in-line oDO sensors that measure at the lowest oxygen ranges.

The InTap is equipped with a Bluetooth interface and can connect to sensors equipped with the T100 Bluetooth tool.

Reference calibration is done with a few clicks and can be transmitted wirelessly to the sensor. All data is stored in the InTap's USB-connected storage and a database of measurement points is easily built up.

### Specifications

Measurement parameters	DO saturation e.g. concentration and temperature
Operating range*	0 ppb to 2000 ppb
Accuracy*	$\leq \pm [1\% + 2 \text{ ppb}]$
Response time at 25°C (air to N <sub>2</sub> ); † 98%	< 20s
Temperature measuring range	-5 to 60 °C (23 to 140 °F)
Operating pressure range	0 to 6 bar
Design pressure	12 bar
Protection rating	IP 67
Weight	3.5 kg
Battery	24 to 48 h
Data storage	1 GB

\*Sensor specifications

### Features Overview

- 4.0" touchscreen
- Fast response time
- Lowest calibration requirement
- Highest accuracy down to 2 ppb
- IP 67 enclosure resists harsh environments

### Other Highlights

- Full user management
- Wireless in-line sensor calibration
- Data logging up to 24 h
- Measurement point data management
- Calibration report management
- ISM predictive maintenance tools

## Ordering Information

Analyzer		Order Number
InTap portable oDO analyzer		30 425 550
InTap portable oDO analyzer imp. inch/US		30 457 912
Accessories		Order Number
T100 M12 Bluetooth Interface for in-line sensor		30 432 819
Replacement Parts		Order Number
InTap 12V Power Supply Set		30 383 009
OptoCap for InTap (OptoCap BR01)		52 206 403
O <sub>2</sub> sensor InTap		30 422 571
Polyamide hose $\varnothing$ 6×4 mm		30 422 575
Polyamide hose $\varnothing$ 1/4" (2m)		30 461 774



T100: Bluetooth interface for oDO sensors.



Touchscreen interface with convenient data management

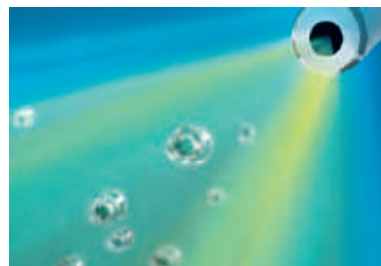

Stable and accurate results with minimized calibrator demands.

Beyond optical technology METTLER TOLEDO has implemented Automatic Stability Control (ASC) to ensure stable and reliable results, also minimizing calibration demands.



With the InTap you can store the calibration data of installed sensors and build up an electronic database for sensor management. Data is stored on a USB stick and can be transferred conveniently to a PC.



**Did You Know**  
Installed oDO sensors can be upgraded with the T100 Bluetooth tool, allowing calibration data to be sent wirelessly to the InTap.

## InPro 6050 Continuous Control of Your Wastewater Application



The InPro 6050 dissolved oxygen sensor provides reliable continuous measurement of dissolved oxygen in water applications including biological treatment in wastewater. The InPro 6050 offers proven Ingold sensor technology with an integrated thermistor in a rugged plastic sensor body providing optimum measurement accuracy at an affordable price. The PTFE/silicone membrane is reinforced by an integral stainless steel mesh, which provides durability and mechanical stability to ensure reliable, continuous on-line measurement.

### Specifications

#### Performance

Operating range	30 ppb to saturation
Accuracy	± [1 % + 30 ppb]
Response time at 25 °C (77 °F)	98 % of final value in < 90 s
Sensor signal in air at 25 °C (77 °F)	40 to 110 nA
Residual signal in oxygen-free medium	< 0.3 % of the signal in ambient air

#### Construction

Measuring principle	Amperometric Clark electrode
Cable connection	VP
Connector design	Straight
Process connection	Pg 13.5
Sensor body	PPS
Membrane material	PTFE/Silicone/PTFE (reinforced w/steel mesh)
O-ring material	Viton®, Silicone
Sensor diameter	12 mm
Shaft length	120 mm

#### Working Conditions

Temperature compensation	Automatic
Measuring temperature range	0 to 60 °C (32 to 140 °F)
Design pressure	Maximum 2 bar (29 psi absolute)

#### Certificates and Approvals

METTLER TOLEDO Quality Certificate

### Features Overview

- Rugged sensor designed for the wastewater industry
- Low maintenance
- Accurate measurement and quick response
- Long lasting and easy to maintain membranes
- Watertight VP connector (IP 68)
- PTFE coated membrane protects the membrane against particle adhesion and chemical interference

### Ordering Information

Sensor	Length	Connector Style	Order Number
InPro 6050	120 mm	Straight VP	52 200 851

### InPro 6050 Consumables

#### Order Number

Membrane body, single T-96	52 200 071
Membrane kit T-96 (4 membranes, 1 O-ring set, 25 ml of electrolyte)	52 200 024
O <sub>2</sub> electrolyte pack (3 × 25 ml)	30 298 424

For accessories and spare parts refer to p. 53

► [www.mt.com/InPro6050](http://www.mt.com/InPro6050)

# Oxygen Accessories and Spare Parts

## For Efficient Operation



Membrane kit with 4 membranes and electrolyte

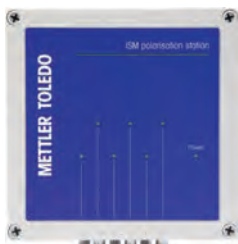

6-port ISM polarization station for digital oxygen sensors



ISM O<sub>2</sub> Verification Kit. See page 104 for details.



ISM Optical O<sub>2</sub> Verification Kit. See page 105 for details.

An oxygen measuring system is made up of several important components and because the measurement is so critical to the process, all of them need to operate efficiently. This section outlines the accessories and maintenance items that can be used to optimize and maintain the quality of measurement.

### Membrane maintenance

Perhaps the most common problem seen over time with electrochemical oxygen sensors is membrane integrity. During the course of a membrane's life it may encounter difficult situations such as harsh samples, multiple sterilization cycles, or impact, all of which cause normal wear and tear on the membrane. Ingold pioneered the design of the PTFE and silicone membrane with a built-in steel mesh that greatly increases membrane durability, extends membrane life and can be easily and quickly replaced as required. We offer multiple membrane styles according to your application including those that have FDA positive listed components for wetted parts.

### Spare Parts – Ordering Information

InPro 6800 and InPro 6000 Series Sensor Membranes	Order Number
Membrane kit, S-96 (silicone)	52 200 025
Membrane kit, T-96 (PTFE)	52 200 024
Membrane body, single, S-96	52 200 072
Membrane body, single, T-96	52 200 071
O <sub>2</sub> electrolyte pack (3 × 25 ml)	30 298 424
Cap sleeve N (no protective cage)	52 200 037
Cap sleeve P (protective cage)	52 200 038
Cap sleeve N, HA-C22	52 200 642

### Accessories – Ordering Information

Product Description	Order Number
Digital ISM sensor master	52 206 329
Digital ISM sensor 6-port polarization station	52 206 480
ISM simulator O <sub>2</sub> Kit for InPro 6850i/6850iG	52 300 416
ISM simulator O <sub>2</sub> ppb Kit for InPro 6900i/6900iG	52 300 422
ISM simulator O <sub>2</sub> Trace Kit for InPro 6950i/6950iG	52 300 428
InPro 6800 sensor master polarization unit	52 200 892
InPro 6900 sensor master polarization unit	52 200 893
InPro 6950 sensor master polarization unit	52 206 113
DO sensor simulator for T-82 cabled transmitters	59 906 816
DO sensor simulator for VP cabled transmitters	52 200 891
Oxygen zeroing gel (3 × 25 mL)	30 300 435
Adapter T-82 cable to VP electrode connector	52 200 939
Adapter VP cable to T-82 electrode connector	52 200 940
Cap sleeve without protective cage N-type (SS 316L)	52 200 037
Cap sleeve with protective cage P-type (SS 316L)	52 200 038
Cap sleeve without protective cage N-type (C22)	52 200 642
Cap sleeve without protective cage N-type (Ti)	52 200 268
Optical O <sub>2</sub> Simulator	30 404 694

## Introduction

Reliable Monitoring and Control of the CO<sub>2</sub> Level

# In Situ Monitoring of Dissolved CO<sub>2</sub> in Bioreactors For Successful Fermentation

### The importance of dissolved carbon dioxide in biotech or pharmaceutical processes

Besides pH and dissolved oxygen measurements, reliable monitoring and control of the CO<sub>2</sub> partial pressure is important for successful fermentation. METTLER TOLEDO Ingold's CO<sub>2</sub> system delivers precise, real-time data that increases understanding of critical fermentation and cell culture processes. This information will help you gain insight into cellular metabolism and other changes within the bioreactor.

A significant trend in biotechnology today is the increasing use of mammalian cell lines including human, monkey, mouse and bovine cells. Various types of bioreactors are now being used to cultivate these animal cells. One of the most important requirements for optimal cell growth in a bioreactor is continuous monitoring and control

of critical parameters, which include O<sub>2</sub>, pH, CO<sub>2</sub> and temperature. Reliable measurement of CO<sub>2</sub> is essential for successful large-scale operation as the accumulation of CO<sub>2</sub> becomes more problematic at high viable cell concentrations. High CO<sub>2</sub> concentrations can inhibit cell growth and product formation in mammalian cells and alter the glycosylation pattern of recombinant proteins. By maintaining low and constant levels of CO<sub>2</sub>, the production rate of pharmaceuticals, proteins and antibodies can be significantly increased.

### Dissolved carbon dioxide sensors

The InPro 5000 i dissolved CO<sub>2</sub> sensor utilizes the Severinghaus principle of CO<sub>2</sub> measurement which was developed in 1958 for use in blood-gas analysis. The sensing electrode in this principle is an enhanced pH electrode separated from the measurement media by an electrolyte-filled gas permeable

membrane. CO<sub>2</sub> diffuses through the membrane and into the inner electrolyte where it equilibrates with bicarbonate ions, altering the pH value. The relative change in pH value of the electrolyte is then measured by the enhanced pH electrode and correlated to CO<sub>2</sub>.

The InPro 5000 i series sensor has been optimized for in situ analysis of dissolved CO<sub>2</sub> in fermentation and cell culture processes. This sensor has a high surface finish for ultimate cleanability and can be steam sterilized or autoclaved. The modular membrane allows for maintenance in seconds and its unique construction stops interference of volatile acids which are often found in bioprocesses.



A perfect team: M400 transmitter with InPro 5000 i CO<sub>2</sub> sensor

Measuring principle of the InPro 5000 i sensor

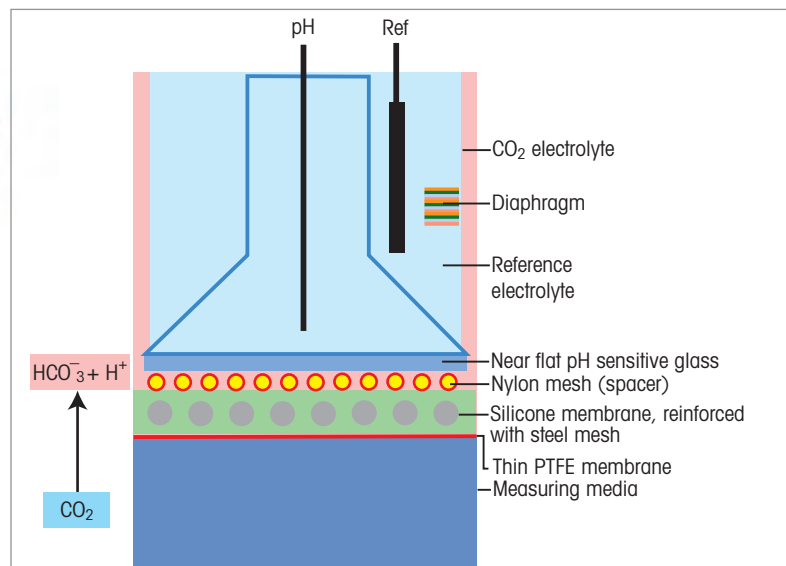



# In-line CO<sub>2</sub> Measurement in Beverages

## Proven Technology, Simplified Operation

**In-line CO<sub>2</sub> measurements in brewery and carbonated soft drinks processes are commonly used to ensure consistent beverage quality. However, initial investment, installation costs, and expenditure caused by unscheduled system downtime can amount to an unfavorable total lifetime cost of measurement equipment. A sensor that offers simplified handling and enhanced diagnostics leads to more reliable and cost effective operation.**

### Importance of CO<sub>2</sub> measurements

For consumers, the mouthfeel (and foam in the case of beer) is as important as a beverage's taste. Monitoring and controlling dissolved CO<sub>2</sub> concentrations helps ensure consumers experience the sight and effervescence of your products the way you want them to. Consequently, typical applications for in-line CO<sub>2</sub> measurement systems in beverage producing processes are:

- Beverage carbonation control
- Measurements in filling lines
- Monitoring of possible CO<sub>2</sub> losses in critical process steps
- Deaerated water carbonation control

As much as reproducible CO<sub>2</sub> concentrations are responsible for consistent product quality, different packaging solutions also require different CO<sub>2</sub> levels for beverage dispensing and process safety reasons, e.g. to avoid mechanical damage to cans in tunnel pasteurizers due to high CO<sub>2</sub> levels. Table 1 shows typical concentration ranges for different beverages and packages.

### Thermal conductivity plus Intelligent Sensor Management

The InPro 5500 i combines enhanced TC measurement with the proprietary Intelligent Sensor Management (ISM) concept. ISM simplifies sensor handling, enhances reliability and reduces sensor lifecycle costs. Plug and Measure installation and predictive maintenance tools, such as an indicator for falling membrane integrity, increases measurement point uptime and improve process safety.

Together with the M400 ISM transmitter operators can take full advantage of features that non-ISM systems cannot match.

Product	Typical CO <sub>2</sub> Concentration
Deaerated water used in blending processes	2 g/L (1 Vol) up to concentration of packaged beverage
Beers filled in cans/kegs	Up to 5.2 g/L (2.6 Vol)
Bottom fermented beers in bottles	5 to 6 g/L (2.5 to 3.0 Vol)
Top fermented beers in bottles	6 to 9 g/L (3 to 4.5 Vol)
Carbonated soft drinks	5 to 10 g/L (2.5 to 5 Vol)

Table 1: Typical CO<sub>2</sub> ranges in carbonated beverages

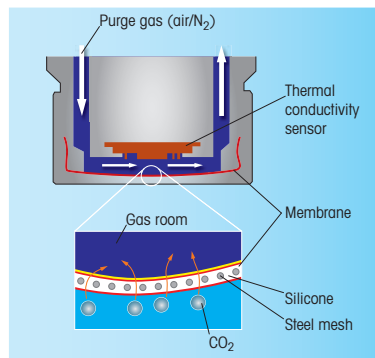

Fig 1: TC sensor design – complete avoidance of moving parts



Fig 2: METTLER TOLEDO's InPro 5500 i in-line dissolved CO<sub>2</sub> sensor employs thermal conductivity measurement

## InPro 5000 i For Accurate CO<sub>2</sub> Measurement



**USP**  
Class VI

**FDA**



**ISM**<sup>®</sup>

The InPro 5000 i dissolved carbon dioxide sensor allows for the accurate measurement and control of dissolved CO<sub>2</sub> in biopharmaceutical applications. The measuring principle is based on the Severinghaus principle of potentiometric CO<sub>2</sub> measurement which has been widely accepted for over 55 years. The high surface finish of the stainless steel sensor prevents contamination and the sensor is fully sterilizable either in-situ or in an autoclave. The design of the membrane dramatically reduces full service time to just minutes. The interior body, a high performance pH electrode, can easily be replaced at your site. No need to send the sensor in for service. Also available with Intelligent Sensor Management (ISM) for Plug and Measure and advanced diagnostics (see pages 10-11).

### Specifications

<b>Performance</b>	
Measuring range	10 to 1000 mbar pCO <sub>2</sub>
Accuracy	± 10 % (pCO <sub>2</sub> 10 to 900 mbar) ± 15 % (pCO <sub>2</sub> > 900 mbar)
Response time	90 % of final value < 120 s at 25 °C (77 °F)
<b>Construction</b>	
Measuring principle	Potentiometric Severinghaus
Cable connection	K8S
Process connection	Pg 13.5
Sensor body	316 L stainless steel
Membrane material	Silicone (reinforced with steel mesh)
Surface roughness of wetted parts	N5 (R <sub>a</sub> = 0.4 μm / 16 μin)
O-ring material	Viton <sup>®</sup> , Silicone (FDA compliant)
Sensor diameter	12 mm
<b>Working Conditions</b>	
Temperature compensation	Automatic
Temperature sensor	Digital
Measuring temperature range	0 to 60 °C (32 to 140 °F)
Sterilization temperature	135 °C / 275 °F (sterilizable and autoclavable)
Operating pressure	0.2 to 2 bar (3 to 30 psi)
Design pressure	Maximum 3 bar (42 psi) at 25 °C (77 °F)
<b>Certificates and Approvals</b>	
	METTLER TOLEDO Quality Certificate, EHEDG, FDA, USP Class VI, 3.1, N5/R <sub>a</sub> 16

### Other Highlights

- Small 12 mm diameter saves valuable space
- Pg 13.5 threads for interface into vessels or housing
- Variety of sensor lengths available

### Features Overview

- Revolutionary design of the sensor allows for full service in seconds
- In situ measurement of CO<sub>2</sub>
- Autoclavable and steam sterilizable
- Accurate measurement and quick response
- Long lasting and easy to maintain membranes
- FDA positive listed materials of construction
- High surface finish of N5 (R<sub>a</sub> = 0.4 μm / 16 μin)
- EHEDG certified for cleanability
- Wetted O-rings comply with FDA and USP VI standards

► [www.mt.com/InPro5000](http://www.mt.com/InPro5000)

## Ordering Information

### 12 mm InPro 5000 i CO<sub>2</sub> Sensors

Sensor	Length	Connector Style	Order Number
InPro 5000i	120mm	K8S	30 013 606
InPro 5000i	220mm	K8S	30 019 005
InPro 5000i	320mm	K8S	30 019 006

### Transmitter

Transmitter	Order Number
M100 SM 1-wire	30 365 366
M400 Type 2	30 374 112
M400 Type 3	30 374 113
M400 PA	30 026 617
M400 FF	30 026 616
M400 FF 4-wire	30 374 121
M800 Process, 1-channel	30 026 633
M800 Process, 2-channel	52 121 813
M800 Process, 4-channel	52 121 853
M800 Process 1-channel SST	30 246 551
M800 Process 2-channel SST	30 246 552
M800 Process 4-channel SST	30 246 553

### InPro 5000 i Consumables

InPro 5000 i Consumables	Order Number
InPro 5000 i membrane kit (4 membranes, 1 O-ring set, 25 ml of electrolyte)	52 206 055
Interior body InPro 5000 i, 120mm	30 019 049
Interior body InPro 5000 i, 220mm	30 019 170
Interior body InPro 5000 i, 320mm	30 019 175

### InPro 5000 i Accessories

InPro 5000 i Accessories	Order Number
InPro 5000 i CO <sub>2</sub> ISM Verification Kit	30 031 035
pH buffer 7.00	51 340 059
pH buffer 9.21	51 300 193
Cap sleeve without protective cage N-type	52 201 153
Cap sleeve with protective cage P-type	52 201 154



The InTrac® 797 e can be used to calibrate the InPro 5000 i sensor in pilot and production fermentors, without interrupting the process.



### Did You Know

The InPro 5000 i membrane inhibits the passage of volatile organic acids (a common by-product of biological processes), which would otherwise interfere with CO<sub>2</sub> measurement.

### Suitable Housings

Suitable Housings	p.
InFit 761 e.....	110
InTrac 797 e.....	120
InTrac 781 .....	121

## InPro 5500 i Less Maintenance, Greater Reliability



### Features Overview

- Direct process connections with three choices (Varivent™, Tri-Clamp™, 28 mm/M 42)
- Integrated temperature sensor
- Hygienic design, capable of withstanding CIP procedures
- O-rings with FDA approval
- Stainless steel surface with highly polished finish
- Steam sterilizable up to 120 °C (248 °F)
- Minimal and easiest membrane maintenance

► [www.mt.com/InPro5500i](http://www.mt.com/InPro5500i)

The InPro 5500 i thermal conductivity CO<sub>2</sub> sensor provides reliable in-line measurement of dissolved carbon dioxide for a wide spectrum of food and beverage (brewery and carbonated soft drinks) processes. Intelligent Sensor Management (ISM) technology simplifies sensor handling and reduces sensor lifecycle cost. The InPro 5500 i thermal conductivity CO<sub>2</sub> sensor offers outstanding features, e.g., direct process connections, and integrated temperature sensor. Its hygienic design is capable of withstanding CIP procedures. Furthermore, the sensor is equipped with ISM technology which provides unique features such as Plug and Measure, automatic sensor protection, and predictive maintenance functions (see pages 10–11).

### Specifications

#### Performance

Measuring range	0 to 10 bar p (CO <sub>2</sub> )/0 to 145 psig p (CO <sub>2</sub> ) 0 to 15 g/L CO <sub>2</sub> , 0 to 7 V/V CO <sub>2</sub>
Accuracy in fluids	± 1 % within ± 5 % °C of calibration temperature ± 2 % over temperature range 0 to 50 °C (32 to 122 °F)
Cycle time	< 20 s
Flow requirements	min. 0.5 m/s

#### Construction

Measuring principle	Thermal conductivity
Cable connection (digital)	5-pin, RS 485 data cable
Process connections	Varivent Type N, Tri-Clamp 2", 28 mm with cap nut M 42
Sensor body (wetted parts)	316 L stainless steel
CO <sub>2</sub> selective membrane material	PTFE/Silicone (reinforced with steel mesh)
Surface roughness of wetted parts	N5 (R <sub>a</sub> = 0.4 µm/16 µin)
O-ring material	EPDM (wetted parts), other material on request
Protection class	IP 67

#### Working Conditions

Operating pressure	0 to 20 bar absolute/0 to 290 psi
Design pressure	= permissible pressure range
Permissible temperature range*	0 to 50 °C (32 to 122 °F)
Operating temperature range	– 5 to 121 °C (23 to 250 °F)
Sterilization temperature	up to 120 °C (248 °F)

#### Certificates and Approvals

MaxCert certification package (Material Certificate 3.1, Surface Finish Certificate 2.1, Final Inspection Certificate)

### Other Highlights

- Wide CO<sub>2</sub> detection range – 0 to 15 g/L CO<sub>2</sub>
- Improved thermal conductivity technique for greater accuracy and low drift
- Immunity to background gases results in high CO<sub>2</sub> selectivity
- Predictive maintenance tools such as Dynamic Lifetime Indicator (detects when membrane replacement will be required) and Adaptive Calibration Timer (predicts when calibration should be performed)

**Ordering Information****InPro 5500 i Thermal Conductivity CO<sub>2</sub> Sensors**

Sensor	Order Number
InPro 5500 i/Varivent Type N	30 034 265
InPro 5500 i/Tri-Clamp 2"	30 034 266
InPro 5500 i/28 mm/M42	30 034 264

**Accessories**

Accessories	Order Number
CalBox™	52 300 400
Purge gas conditioner	30 034 319

**Cables**

Cables	Order Number
<b>– Data cable (5-pin) for InPro 5500 i temperature range –30 to 80 °C (–22 to 176 °F)</b>	
RS485/2 m (6.6 ft)	52 300 379
RS485/5 m (16.4 ft)	52 300 380
RS485/10 m (32.8 ft)	52 300 381
RS485/15 m (49.2 ft)	52 206 422
RS485/25 m (82.0 ft)	52 206 529

**Spare Parts**

Spare Parts	Order Number
MembraCap™	30 034 318

**Transmitters**

Transmitters	Order Number
M400 Type 3	30 374 113
M400/2H	30 025 514
M400/2(X)H	30 025 515
M400 FF	30 026 616
M400 PA	30 026 617
M800 SST, 1-channel	30 246 551
M800 SST, 2-channel	30 246 552
M800 Process, 1-channel	30 026 633
M800 Process, 2-channel	52 121 813
M800 Process, 4-channel	52 121 853

**Process connection compatibility**

Varivent, Tri-Clamp and 28 mm/M42 process connections, plus the integrated temperature sensor for more accurate CO<sub>2</sub> measurement, means commissioning is quick and straightforward. The hygienic membrane cap has been designed for ease of cleanability and simple, quick exchange.

**Did You Know**

The InPro 5500 i can be combined with an M400 for a single loop or with an O<sub>2</sub> sensor using the M800 multi-channel transmitter for a complete dual O<sub>2</sub>/CO<sub>2</sub> loop.



# Versatile Turbidity Measurement For Multiple Industries and Applications

**Turbidity measurements are important indicators in many processes as they not only influence the yield of your process but also detect factors which are detrimental to a system.**

### **Backscattered light technology**

With a single optical fiber turbidity sensor, the emitted and backscattered light travels on the same fiber. Linear measurement for medium to high levels of turbidity is possible. With a system of two optical fibers the emitted and backscattered light travels on two fibers. Sensitivity to detect particles is consequently higher.

### **Forward scattered light technology**

This technology provides an optimum measuring range for low to medium turbidity levels. They are ideal for detection of larger particles  $>0.3\ \mu\text{m}$  and with the simultaneous measurement of forward and direct light allows for compensation of color.

### **Turbidity and color monitoring**

The sophisticated digital measuring technology in the InPro 8600i sensor is based on the photometric determination of blue and red light. Whereas the blue light is used to detect the color of the medium, in particular the color of beer, the scattering of red light is used to simultaneously detect the turbidity of the medium.

### **New optical product monitor**

Precise monitoring of phase separation in food and beverage production is easily achieved by applying our InPro 8300 RAMS optical product monitor. Up to eight signals from long-life LEDs allow automated in-line product characterization by turbidity and color, as well as identifying products by their optical "fingerprint".

### **Turbidity sensor selection**

METTLER TOLEDO Ingold offers several types of turbidity sensors that are optimized for specific measurement ranges and different applications. Depending on the applied technology and design they can be used in many industries such as:

- Biotechnology
- Pharmaceutical
- Chemical Processing
- Petrochemical
- Food and Beverage
- Breweries

Sensor versatility matches the requirements of diverse applications in which they can be implemented:

- Fermentation
- Biomass growth (cell density)
- Crystallization
- Phase separation
- Water in oil
- Filter breakthrough
- Activated sludge
- Post filtration of beer
- Wastewater

**Our versatile turbidity measurement systems can be implemented in practically any process.**

**Application guide for turbidity systems**

	25° and 90° scattered light	Backscattered light, 1-fiber	Backscattered light, 2-fibers	In-line product monitor
<b>Industrial processes</b>				
<b>Pharmaceutical Industry</b>				
Biotechnical applications			•	•
ChemPharma				•
<b>Chemical Industry</b>				•
<b>Beverage Industry</b>	•			•
<b>Wastewater applications</b>		•		•

Low and medium turbidity  
InPro 8600i Series  
Medium to high turbidity  
InPro 8050  
InPro 8100  
InPro 8200iS(H) Epoxy  
InPro 8200iS (Kaltrez®)  
InPro 8300 RAMS

**Transmitter selection**

For use with the InPro 8600 i series, the traffic light color-coded touchscreen on the M800 1-channel Process transmitter allows operators to evaluate the sensor and process condition at a glance. The M800 1-channel also provides excellent security (setting can be password protected) and convenient operation.

**Color measurement**

Two precision instruments for turbidity and color in-line measurement are combined into one unique sensor. Our food and beverage industry proven InPro 8600 i incorporates a two-angle

turbidity instrument with an EBC color monitor. Providing two sensors in one maintenance-free instrument means cost of ownership is at a minimum while reliability and easy handling are maximized.

**Turbidity housing selection**

Housing options are available for simple interface into a process. These housings help maintain low maintenance and minimum downtime of your process by allowing easy removal of the turbidity sensor. The housings are designed for strict Clean in Place (CIP) applications and harsh environments.



InPro 8050



InPro 8100



InPro 8200



InPro 8610i/InPro 8630i

Our range of turbidity sensors

# Turbidity Sensors

Durable Sensors for Precise Turbidity Control

Turbidity/Optical Density

## InPro 8050/InPro 8100 (Single Fiber) Wide Measurement Range



InPro 8100

InPro 8050

Single optical fiber: emitted and back-scattered light travel on same fiber.

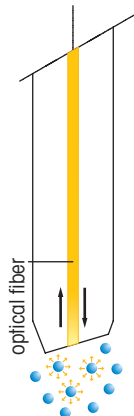

The InPro 8100 and 8050 single optical fiber turbidity sensors are designed for samples that have high particle concentrations and they offer a wide linear measuring range. The InPro 8100 is available in stainless steel and is intended for use in cell culture monitoring, pharmaceutical production, and industrial processes. The InPro 8050 utilizes a rugged polysulfone body and was developed specifically for accuracy and durability in the industrial wastewater environment.

### Specifications

InPro 8050	
Technology	1 – fiber
Measuring range	10 to 4000 FTU 0 to 250g/L (diatomaceous earth as reference)
Shaft material	PSU (Polysulfone)
Shaft lengths	120 mm
Sensor diameter	12 mm
Fiber optic cable	6m (19.7ft), fixed
Sterilizable	No
Autoclavable	No
Explosion protection	No

InPro 8100	
Technology	1 – fiber
Measuring range	10 to 4000 FTU 0 to 250g/L (diatomaceous earth as reference)
Shaft material	Stainless steel (316L)
Shaft lengths	120, 205, 297 or 407 mm
Sensor diameter	12 mm
Surface finish	N5 (R <sub>a</sub> = 0.4 μm/16 μin)
Fiber optic cable	3 m (9.8ft), fixed
Sterilizable	Yes, steam sterilizable at 130 °C (266 °F)
Autoclavable	Yes, for autoclavable version see ordering information next page

**Certificates and Approvals** ATEX, CE and Material certificate according to 3.1

### Features Overview

- Backscattered light technology
- Uniform sensor structure reduces fouling and maintenance
- Wide measuring range
- Broad range of applications
- High accuracy

### Other Highlights

- Small 12 mm diameter saves valuable space
- Pg 13.5 threads for interface into housings
- Integrated fiber optic cable
- Variety of sensor lengths available

▶ [www.mt.com/InPro8100](http://www.mt.com/InPro8100)  
▶ [www.mt.com/InPro8050](http://www.mt.com/InPro8050)



**Ordering Information**

<b>InPro 8050</b>	<b>Length</b>	<b>Shaft Material</b>	<b>Order Number</b>
InPro 8050	120 mm	PSU	52 800 209

<b>InPro 8100</b>	<b>Length</b>	<b>Shaft Material</b>	<b>Order Number</b>
InPro 8100	120 mm	Stainless steel	52 800 205
InPro 8100	205 mm	Stainless steel	52 800 206
InPro 8100	297 mm	Stainless steel	52 800 207
InPro 8100	407 mm	Stainless steel	52 800 208
InPro 8100 autoclavable sensor	120 mm	Stainless steel	contact METTLER TOLEDO
InPro 8100 autoclavable sensor	205 mm	Stainless steel	contact METTLER TOLEDO
InPro 8100 autoclavable sensor	297 mm	Stainless steel	contact METTLER TOLEDO
InPro 8100 autoclavable sensor	407 mm	Stainless steel	contact METTLER TOLEDO

**Accessories**

	<b>Order Number</b>
CaliCap calibration accessory	52 800 210
Fiber cable extension kit 3 m (9.8 ft)	52 800 228
Fiber cable extension kit 5 m (16.4 ft)	52 800 229
Fiber cable extension kit 6 m (19.7 ft)	52 800 230
Fiber cable extension kit 10 m (32.8 ft)	52 800 231
Fiber cable extension kit 15 m (49.2 ft)	52 800 232
Fiber cable extension kit 20 m (65.6 ft)	52 800 233
Fiber cable extension kit 25 m (82.0 ft)	52 800 234
Fiber cable extension kit 30 m (98.4 ft)	52 800 235
Couplings to link fiber cables (two included in every kit)	52 800 240
Coupling box IP65 (NEMA 4X)	52 800 241
Swagelok™ adapter NPT 1/2"	52 800 242

Longer cable lengths are available. Please contact METTLER TOLEDO Ingold for details.

**Transmitter**

	<b>Order Number</b>
M800 Process 1-channel	30 026 633



Fiber optic extension cable



Coupling box for fiber optic cable

M800 1-channel transmitter



**Suitable Housings**

	<b>p.</b>
InFit 761 e.....	110
InFit 762 e/763 e.....	112
InFlow .....	114
InDip .....	113
InTrac 779 e.....	119
InTrac 799 e.....	120
InTrac 785 .....	122

## Turbidity Sensors

Durable Sensors for Precise Turbidity Control

Turbidity/Optical Density

### InPro 8200 (Dual Fiber) High Resolution at Medium Turbidity



Two optical fibers:  
for emitted and  
backscattered  
light protected by  
scratch resistant  
sapphire window.

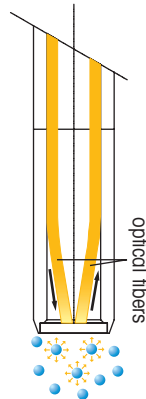

The InPro 8200 dual optical fiber turbidity sensor is designed for samples with medium to high concentration and where high resolution is a requirement. The InPro 8200 is available in stainless steel or Hastelloy™ and is intended for use in cell culture monitoring, crystallization control, and industrial processes including liquid/solid separation.

#### Specifications

Technology	2-fiber
Measuring range	5 to 4000 FTU 0 to 30 g/L (diatomaceous earth as reference)
Shaft material	Stainless steel (316 L) Hastelloy
Shaft lengths	120, 205, 297 or 407 mm
Sensor diameter	12 mm
Surface finish	N5 ( $R_a = 0.4 \mu\text{m} / 16 \mu\text{in}$ )
Fiber optic cable	3 m (9.8 ft), fixed
Sterilizable	Yes, steam sterilizable at 130 °C (266 °F)
Autoclavable	No
<b>Certificates and Approvals</b>	ATEX, CE and Material certificate according to 3.1

#### Features Overview

- Backscattered light technology
- Uniform sensor structure reduces fouling and maintenance
- Wide measuring range
- Broad range of applications
- High accuracy
- Sapphire window

#### Other Highlights

- Small 12 mm diameter saves valuable space
- Pg 13.5 threads for interface into housings
- Integrated 3 m (9.8 ft) fiber optic cable
- Variety of sensor lengths available

▶ [www.mt.com/InPro8200](http://www.mt.com/InPro8200)

### Ordering Information

Sensor	Length	Shaft Material, Window Seal	Order Number
InPro 8200	120 mm	Stainless steel, Epoxy	52 800 216
InPro 8200	205 mm	Stainless steel, Epoxy	52 800 217
InPro 8200	297 mm	Stainless steel, Epoxy	52 800 218
InPro 8200	407 mm	Stainless steel, Epoxy	52 800 219
InPro 8200	120 mm	Hastelloy, Epoxy	52 800 220
InPro 8200	205 mm	Hastelloy, Epoxy	52 800 221
InPro 8200	297 mm	Hastelloy, Epoxy	52 800 222
InPro 8200	407 mm	Hastelloy, Epoxy	52 800 223
InPro 8200/S/Kalrez®-FDA/120	120 mm	Stainless steel, Kalrez®-FDA	52 800 224
InPro 8200/S/Kalrez®-FDA/205	205 mm	Stainless steel, Kalrez®-FDA	52 800 225
InPro 8200/S/Kalrez®-FDA/297	297 mm	Stainless steel, Kalrez®-FDA	52 800 226
InPro 8200/S/Kalrez®-FDA/407	407 mm	Stainless steel, Kalrez®-FDA	52 800 227
InPro 8200/H/Kalrez®-FDA/120	120 mm	Hastelloy, Kalrez®-FDA	Contact METTLER TOLEDO
InPro 8200/H/Kalrez®-FDA/205	205 mm	Hastelloy, Kalrez®-FDA	52 800 264
InPro 8200/H/Kalrez®-FDA/297	297 mm	Hastelloy, Kalrez®-FDA	Contact METTLER TOLEDO
InPro 8200/H/Kalrez®-FDA/407	407 mm	Hastelloy, Kalrez®-FDA	52 800 215

Accessories	Order Number
CaliCap calibration accessory	52 800 210
Fiber cable extension kit 3 m (9.8 ft)	52 800 228
Fiber cable extension kit 5 m (16.4 ft)	52 800 229
Fiber cable extension kit 6 m (19.7 ft)	52 800 230
Fiber cable extension kit 10 m (32.8 ft)	52 800 231
Fiber cable extension kit 15 m (49.2 ft)	52 800 232
Fiber cable extension kit 20 m (65.6 ft)	52 800 233
Fiber cable extension kit 25 m (82.0 ft)	52 800 234
Fiber cable extension kit 30 m (98.4 ft)	52 800 235
Couplings to link fiber cables (two included in every kit)	52 800 240
Coupling box IP65 (NEMA 4X)	52 800 241
Swagelok adapter NPT ½"	52 800 242

Longer cable lengths are available. Please contact METTLER TOLEDO Ingold for details.

Transmitter	Order Number
M800 Process 1-channel	30 026 633



#### Did You Know

The CaliCap™ calibration accessory can serve two important functions. Firstly, it can be used as a “dry check” to verify the performance of the Transmitter/Sensor combination. Secondly, it provides stable measurement during off-line calibration in small vessels where reflection can disturb the measurement.



Suitable Housings	p.
InFit 761 e.....	110
InFit 762 e/763 e.....	112
InFlow .....	114
InDip .....	113
InTrac 779 e.....	119
InTrac 799 e.....	120
InTrac 785 .....	122

## InPro 8300 RAMS Series Optical Product Monitoring and Identification Systems



### Features Overview

- Monitoring of turbidity and color using one single unit
- Use of durable and long-lasting LEDs
- Excellent zero stability
- Configuration using a PC or notebook
- Easy to retrofit to VARINLINE access units or VARINLINE sight glasses without the need of welding
- In parallel to processing the switching outputs and the analog output in the PLC, visualization via a separate PC is possible

The InPro 8300 RAMS is an optical multi-switch for monitoring product/water phase separation processes and for the identification of products in the process. In process automation applications, the unit supplies the switching signal for product/water or product/product phase separation. Where a range of products is manufactured, it allows unique identification of the different products. Using up to four different wavelengths, the transmitted light and the back-scattered light are measured. This method allows virtually all liquids to be monitored, independently of their color and turbidity.

### Specifications

<b>Main Module</b>		
Measuring cycle (all 8 parameters)		approx. 5 measurements per second
Reaction time		≤ 1 s
<b>Measuring range</b>	TCS	0...100 % Absorption turbidity or color system
	BASIC	0...100 % Absorption and/or reflection at four wavelengths for product identification
	CAL/COMBINE	Turbidity 0...50/100/200/500/1000 EBC (factory calibrated) Color 0...15/30/60/150 EBC (factory calibrated)
Repeatability		± 1 % of measuring range
Power supply		24 VDC ± 5 %
Power consumption		< 50 mA plus total of output currents, polarity reversal protection up to 30 V
Output signal		4...20 mA Calibrated Range or 0...100 % Abs. / refl.
Configuration interface		RS 232
<b>Operating conditions</b>		
Ambient temperature		0 to 40 °C (32 to 104 °F)
Product temperature		0 to 105 °C (32 to 221 °F) (140 °C/284 °F optional)
Rel. humidity		0 to 100 %
Protection class		IP 67
<b>Materials</b>		
Housing		1.4404
Seals		EPDM/optional Viton®
Viewing window		PVC
Cable glands		brass/nickel plated
<b>OPL-Bits</b>		
Housing material		1.4404
Sealing material		EPDM, optional Viton®
Window material		Borosilicate, sapphire (optional)
Operating pressure		max. 10 bar
Mechanical temp. resistance		– 5 to + 180 °C (23 to 356 °F) (depending on the sealing material)

► [www.mt.com/InPro8300](http://www.mt.com/InPro8300)

### Ordering Information

Accessories InPro 8300 RAMS	Order Number
OPL bit 0 mm borosilicate window	52 801 153
OPL bit 8 * mm borosilicate window	52 801 124
OPL bit 19 * mm borosilicate window	52 801 125
OPL bit 22 * mm borosilicate window	52 801 126
OPL bit 37 * mm borosilicate window	52 801 127
OPL bit 42 * mm borosilicate window	52 801 128
OPL bit 47 * mm borosilicate window	52 801 129
OPL bit 58 * mm borosilicate window	52 801 130
O-ring set for active and passive part 34.59 × 2.62 mm, EPDM	52 801 150
O-ring set for OPL-Bits, EPDM (FDA)	52 801 151
Desiccant	52 801 134

\* Optional available with sapphire window.

### Configurator InPro 8300 RAMS

<b>16-17 Type</b>												
BA BASIC												
TC TCS (Turbidity or Color System)												
CA CALI												
CO COMBINE												
<b>19 Temperature</b>												
S Standard												
H High Temperature												
<b>21-22 OPL-bit 1 for detector side</b>												
00 (0 mm/0°)												
08 (8 mm/0.315°)												
19 (19 mm/0.748°)												
22 (22 mm/0.866°)												
37 (37 mm/1.457°)												
42 (42 mm/1.654°)												
47 (47 mm/1.850°)												
58 (58 mm/2.283°)												
<b>24-25 OPL-bit 2</b>												
00 (0 mm/0°)												
08 (8 mm/0.315°)												
19 (19 mm/0.748°)												
22 (22 mm/0.866°)												
37 (37 mm/1.457°)												
42 (42 mm/1.654°)												
47 (47 mm/1.850°)												
58 (58 mm/2.283°)												
<b>27 Window</b>												
B Borosilicate												
S Sapphire												
<b>29-31 Diameter</b>												
25 DN 25												
40 DN 40												
50 DN 50												
65 DN 65												
80 DN 80												
100 DN 100												
150 DN 150												
<b>33 Measurement</b>												
T Turbidity												
C Color												
			<b>Calibration 1</b>		<b>Calibration 2</b>		<b>Calibration 3</b>					
			min	max	min	max	min	max				
<b>Ordering Code:</b>												
InPro 8300 RAMS/												
1-15		/	/	/	/	/	/	/	/	/	/	/

InPro 8300 RAMS



InPro 8300 RAMS software "CONFI"



### Other Highlights

- A PC can be connected to record measured data (min. 3 s increments)
- Product identification can be displayed in table or chart form
- Easy copying of data into Excel™
- Automatic self-monitoring of condensation forming on the optical windows
- Sapphire windows available as an option
- High-temperature version available as an option

# Conductivity/Resistivity Systems

## When Optimal Performance Is Essential

**Electrolytic conductivity is a widely used analytical parameter for water purity analysis, monitoring of reverse osmosis, cleaning procedures, control of chemical processes, and in industrial wastewater.**

### Three commonly used techniques

Electrolytic conductivity is a measure of the total ionic content of a solution. There are three main methodologies to measure conductivity:

- 2-electrode sensors are for measurements in high purity water and relatively low conductivity ranges
- 4-electrode sensors are for mid to high ranges. They are more resistant to fouling than 2-electrode designs
- Inductive sensors cover mid to very high conductivity ranges, and are particularly resistant to fouling.

METTLER TOLEDO offers all three methodologies.

### 2-electrode sensor design

An AC voltage is applied across the two electrodes, and the resistance between them is measured. The built-in temperature sensor provides fast accurate measurement. The cell geometry and the high solution resistance allow for very accurate and precise conductivity determination.

Sensors are used for: water conditioning and purification stages where they are capable of detecting minute levels of impurities in ultrapure water.

### 4-electrode sensor design

An AC voltage is applied across the two outside electrodes. The principle is to measure the voltage drop across the two inner electrodes. This eliminates polarization errors. Since this technique measures potential drop the measurement remains accurate.

It permits easier in-line cleaning and it can be installed in smaller piping than inductive sensors.

Sensors are used for: concentration measurement of acids, alkalis, and salt process streams.

### Inductive sensor design

The inductive or “electrodeless” conductivity sensor consists of two toroidal coils encapsulated in an inert polymer body. When placed in a conductive solution, a current loop is generated proportional to the conductivity of the solution.

They are ideal for very high conductivity measurements as found in chemical processes, and aggressive applications where contacting electrodes may not be suitable.

### Continuous conductivity monitoring according to USP <645>

USP guideline <645> sets a standard for the quality assessment of USP waters based on measurement of the electrolytic conductivity. There is a 3-stage test in which stage 1 allows on-line, non-temperature compensated conductivity measurement. There are specific requirements for the sensors and transmitters (see table below).

## Application guide for conductivity sensors

Where to use	Ingold sensors										
	InPro 7000-VP	InPro 7001-VP	InPro 7002-TC-VP	InPro 7005-VP	InPro 7108-25-VP	InPro 7108-TC-VP	InPro 7108-VP/CPVC	InPro 7108-VP/PEEK	InPro 7100/InPro 7100i	InPro 7250HT PEEK & PFA	InPro 7250ST PEEK
Pure and ultrapure water	•	•									
Sanitary			•								
Water purification				•				•			
SIP					•	•					
Industrial wastewater						•			•	•	
Medium/high conductivity							•	•	•		
Aggressive chemicals								•	•		
Chemical applications								•	•	•	
Pharmaceutical water								•			
High conductivity									•		
Chemical concentration									•		

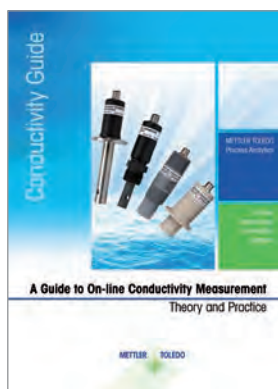

Find out more in our comprehensive conductivity theory guide at [www.mt.com/conductivity](http://www.mt.com/conductivity)

Specification	USP <645>
Conductivity sensor and cell constant accuracy	Verify cell constant within $\pm 2\%$ using a reference solution
Conductivity meter calibration	NIST traceable 0.1% precision resistors in place of sensor
Instrument resolution	0.1 $\mu\text{S}/\text{cm}$
Instrument accuracy at 1.3 $\mu\text{S}/\text{cm}$	0.1 $\mu\text{S}/\text{cm}$
Temperature compensation	Must be read uncompensated
Instrument dynamic range	$10^2$

METTLER TOLEDO instruments meet USP <645> water conductivity requirements.



InPro 7250 HT



InPro 7108-VP/PEEK



InPro 7005-VP



InPro 7002-TC-VP



InPro 7100i

## InPro 7000-VP 2-Electrode Design



InPro 7000-VP



InPro 7005-VP



InPro 7002-VP



InPro 7001-VP



The InPro 7000-VP series are 2-electrode conductivity sensors designed for high accuracy measurements in very low to medium conductivity water. The sensors are available in a wide selection of process connections to meet every application need. Series includes hygienic and sterilizable designs.

### Ordering Information

InPro 7000-VP Series 2-Electrode Sensors	Order Number
InPro 7000-VP	52 001 995
InPro 7005-VP	52 001 996
InPro 7001 / 120-VP 3.1	52 001 997
InPro 7001 / 225-VP 3.1	52 001 998
InPro 7002 / 1.5" TC-VP 3.1	52 001 999
InPro 7002 / 2" TC-VP 3.1	52 002 000
InPro 7002-VAR-VP 3.1	52 002 857

### Cables

Cables	Order Number
1.5 m (4.9 ft)	58 080 201
3.0 m (9.8 ft)	58 080 202
4.5 m (14.8 ft)	58 080 203
7.5 m (24.6 ft)	58 080 204
15.0 m (49.2 ft)	58 080 205
25.0 m (82.0 ft)	58 080 206
30.0 m (98.4 ft)	58 080 207
Adapter (VP to old patch cord, 1 m/3.3 ft)	58 080 101

### Features Overview

- Watertight VarioPin connector (IP68) for easy connection and excellent signal transmission
- MaxCert certification package includes NIST/ASTM traceable cell constant, 3.1 materials certificate, and FDA compliant materials documentation

### Typical Applications

- Water conditioning and preparation in the chemical, pharmaceutical and food and beverage industries

► [www.mt.com/InPro7000](http://www.mt.com/InPro7000)



## Specifications

	InPro 7000-VP	InPro 7005-VP	InPro 7001-VP	InPro 7002-VP
Measurement principle	2-electrode sensor	2-electrode sensor	2-electrode sensor	2-electrode sensor
Electrode material	Titanium	Titanium	SS 316 L	SS 316 L
Body material	PVDF	PTFE-coated. SS 316/1.4401	SS 316 L	SS 316 L
RTD	Built-in Pt 1000	Built-in Pt 1000	Built-in Pt 1000	Built-in Pt 1000
Insertion length	29 mm (1.15")	34 mm (1.35")	120/225 mm (4.71/8.86")	85/104 mm (3.35/4.09")
Max. sensor length	153.20 mm (6.03")	75 mm (2.95")	194/299 mm (7.64/11.77")	156/175 mm (6.14/6.88")
Process connection	¾" NPT 1" NPT conduit	¾" NPT	Pg 13.5	Tri-Clamp 1.5" Tri-Clamp 2" Tuchenhagen- VARIVENT DN 40–DN125
Measuring range	See separate table below			
Cell constant nominal	0.1 cm <sup>-1</sup>	0.1 cm <sup>-1</sup>	0.1 cm <sup>-1</sup>	0.1 cm <sup>-1</sup>
Cell constant accuracy	±1.0%	±1.0%	±1.0%	±1.0%
<b>Working Conditions</b>				
Max. pressure at 25 °C (77 °F)	34 bar (493 psig)	17 bar (246 psig)	17 bar (246 psig)	31 bar (449.5 psig)
Max. pressure at 95 °C (203 °F)	7 bar (100 psig)	7 bar (100 psig)	7 bar (100 psig)	10 bar (145 psig)
Measuring temperature range	-10...100 °C (14...212 °F)	-10...100 °C (14...212 °F)	-10...100 °C (14...212 °F)	-10...120 °C (14...248 °F)
Temperature range (sterilization)	N/A	N/A	Sterilizable -10...131 °C (14...268 °F)	Sterilizable -10...155 °C (14...311 °F)
Temperature accuracy at 25 °C (77 °F)	±0.25 °C (±0.5 °F)	±0.25 °C (±0.5 °F)	±0.25 °C (±0.5 °F)	±0.25 °C (±0.5 °F)
<b>Design</b>				
Temperature compensation	Pt 1000 IEC class A	Pt 1000 IEC class A	Pt 1000 IEC class A	Pt 1000 IEC class A
Cable connection	Vario Pin (IP 68)	Vario Pin (IP 68) <sup>a</sup>	Vario Pin (IP 68)	Vario Pin (IP 68)
Wetted parts:				
– Metals	Titanium (Grade 2)	Titanium (Grade 2)	SS 316 L	SS 316 L
– Plastics	PVDF (FDA)	PTFE-coated. SS 316/1.4401		
– O-rings	Viton® (FDA)	Viton® (FDA)	Viton® (FDA)	Viton® (FDA)
– Insulation	PEEK (FDA)	PEEK (FDA)	PEEK (FDA)	PEEK (FDA)
– Surface roughness of wetted metal parts <sup>b</sup>	N/A	N/A	Polished N4 (R <sub>a</sub> < 0.2 μm) (R <sub>a</sub> < 8 μin)	Electropolished N4 (R <sub>a</sub> < 0.2 μm) (R <sub>a</sub> < 8 μin)
<b>Certificates and Approvals</b>				
Cell constant	•	•	•	•
CE certificate	•	•	•	•
Material certificate EN 10204 3.1	–	–	•	•
Material confirmation EN 10204 2.1	•	•	•	•
Surface roughness	–	–	•	•
ATEX (II 1/2G Ex ia)	•	•	•	•

<sup>a</sup> The VP is at the end of an approx. 0.5 m (1.64 ft) long fixed cable. <sup>b</sup> Except at active electrode areas.

## Measuring Ranges 2 - Electrode Design Sensors

Sensors	Transmitters					
	M300	M400 4 - W	M400 2 - W	M700	M800 1-channel	System Accuracy (±)
InPro 7000-VP/7005-VP	0.02–2000	0.02–2000	0.02–2000	0.02–10000	0.02–2000	3%
InPro 7001-VP	0.02–500	0.02–500	0.02–500	0.02–500	0.02–500	3%
InPro 7002-VP	0.02–2000	0.02–2000	0.02–2000	0.02–2000	0.02–2000	3%

all values in μS/cm

<b>Suitable Housings</b>	<b>p.</b>
InTrac 781 .....	121

## InPro 7100-VP 4-Electrode Design



InPro 7108-25-VP

InPro 7108-VP/PEEK



InPro 7108-TC-VP

InPro 7108-VP/CPVC



InPro 7108-VAR

The InPro 7100-VP series conductivity sensors utilize 4-electrode technology to expand the range of contacting conductivity for the measurement of medium to high conductivity solutions. The rugged sensor design withstands the most rigorous CIP/SIP procedures in food and pharmaceutical industries. Series includes process connections for industrial processing as well as hygienic 25 mm port and Tri-Clamp fittings.

### Ordering Information

InPro 7100-VP Series 4-Electrode Sensors	Order Number
InPro 7108-VP/CPVC	52 002 001
InPro 7108-VP/PEEK	52 002 002
InPro 7108-VP/PEEK/HA-C22	52 002 003
InPro 7108-VP-25/40-VP	52 002 004
InPro 7108-VP-25/40/HA-C22-VP	52 002 005
InPro 7108-VP-25/65-VP	52 002 006
InPro 7108-VP-25/65/HA-C22-VP	52 002 007
InPro 7108-VP/1.5" TC-VP	52 002 008
InPro 7108/2" TC-VP	52 002 009
InPro 7108-VAR-VP 3.1	52 002 790

Cables	Order Number
1.5 m (4.9 ft)	58 080 201
3.0 m (9.8 ft)	58 080 202
4.5 m (14.8 ft)	58 080 203
7.5 m (24.6 ft)	58 080 204
15.0 m (49.2 ft)	58 080 205
25.0 m (82.0 ft)	58 080 206
30.0 m (98.4 ft)	58 080 207
Adapter (VP to old patch cord, 1 m/3.3 ft)	58 080 101

### Features Overview

- No polarization effects
- Withstands over 200 sterilization cycles (where applicable)
- Smooth flat surfaces resist fouling
- Watertight VarioPin connector (IP68) for easy connection and excellent signal transmission
- MaxCert certification package includes NIST/ASTM traceable cell constant, 3.1 materials certificate, and FDA compliant materials documentation

- WideRange™ technology for wide measuring range and compact, cost-efficient installation

### Typical Applications

- Chemical concentration measurement/control
- Detection of phase separation
- Control of CIP processes
- Wastewater monitoring

[www.mt.com/InPro7100](http://www.mt.com/InPro7100)

## Specifications

	InPro 7108 – VP/CPVC	InPro 7108 – VP/PEEK	InPro 7108 – 25-VP	InPro 7108 – TC – VP InPro 7108 – VAR – VP
Measuring principle	4-electrode sensor	4-electrode sensor	4-electrode sensor	4-electrode sensor
Electrode material	316 L	Sterilizable 316 L or HA-C22	Sterilizable 316 L or HA-C22	Sterilizable 316 L
Body material	CPVC	PEEK	PEEK	PEEK
RTD	Built-in Pt 1000	Built-in Pt 1000	Built-in Pt 1000	Built-in Pt 1000
Insertion length	28 mm (1.10")	28 mm (1.10")	40/65 mm (1.57/2.56")	25 mm (0.98")
Max. sensor length	151 mm (5.96")	126.7 mm (4.99")	123/148 mm (4.86/5.84")	105 mm (4.14")
Process connection	1" NPT 1" NPT conduit	1" NPT	DN25	Tri-Clamp 1.5" Tri-Clamp 2" Tuchenhagen- Varivent DN 40–DN125
Measuring range	See separate table on page 75			
Cell constant nominal	0.25 cm <sup>-1</sup>	0.25 cm <sup>-1</sup>	0.25 cm <sup>-1</sup>	0.25 cm <sup>-1</sup>
<b>Working Conditions</b>				
Max. pressure at 25 °C (77 °F)	7 bar (100 psig)	17 bar (246 psig)	17 bar (246 psig)	17 bar (246 psig)
Max. pressure at 95 °C (203 °F)	–	7 bar (100 psig)	7 bar (100 psig)	7 bar (100 psig)
Measuring temperature range	–10...80 °C (14...176 °F)	–10...140 °C <sup>a</sup> (14...284 °F)	–10...140 °C <sup>a</sup> (14...284 °F)	–10...140 °C <sup>a</sup> (14...284 °F)
Temperature range (sterilization)	N/A	Sterilizable –10...140 °C <sup>a</sup> (14...284 °F)	Sterilizable –10...140 °C <sup>a</sup> (14...284 °F)	Sterilizable –10...140 °C <sup>a</sup> (14...284 °F)
Temperature accuracy at 25 °C (77 °F)	±0.25 °C ±0.5 °F	±0.25 °C ±0.5 °F	±0.25 °C ±0.5 °F	±0.25 °C ±0.5 °F
<b>Design</b>				
Temperature compensation	Pt 1000 IEC class A	Pt 1000 IEC class A	Pt 1000 IEC class A	Pt 1000 IEC class A
Cable connection	Vario Pin (IP 68)	Vario Pin (IP 68)	Vario Pin (IP 68)	Vario Pin (IP 68)
Wetted parts:				
– Metals	316 L	316 L or HA-C22	316 L or HA-C22	316 L
– Plastics	CPVC	PEEK (FDA)	PEEK (FDA)	PEEK (FDA)
– O-rings	N/A	N/A	EPDM (FDA)	N/A
<b>Certificates and Approvals</b>				
Cell constant	•	•	•	•
CE certificate	•	•	•	•
Material certificates				
EN 10204 3.1	•	•	•	•
Material confirmation 2.1	•	•	•	•
ATEX (II 1/2G Ex ia)	•	•	•	•

<sup>a</sup> Short term 150 °C (302 °F)

## InPro 7100 (i) Convenient Sensors for All Your Processes



InPro 7100

InPro 7100 i

### Features Overview

- Wide measurement range (0.02–500 mS/cm, depending on the transmitter)
- High resistance against aggressive chemicals
- Compatible with a variety of our static and retractable housing
- WideRange technology

The InPro 7100 is particularly suited for applications in the Chemical Industry, Pharmaceutical Industry, Food & Beverage and Pulp & Paper. The fast response time allows quick detection of process changes, leading to better process control. The PEEK shaft material offers high resistivity against aggressive solutions and is particularly suitable in process with frequent CIP/SIP cycles. The InPro 7100 is compatible with a variety of static (InDip® or InFit® series) and retractable (InTrac® series) housings giving the user a wide choice of installation options.

### Specifications

#### Performance

Cell constant nominal	0.31 cm <sup>-1</sup>
System accuracy	± 5 % or better
Operation range	0 to 20 bar at 135 °C (0 to 290 psi at 275 °F) 0 to 10 bar at 150 °C (0 to 145 psi at 302 °F)
Temperature range (sterilization)	Sterilizable –20 to 150 °C (–4 to 302 °F)
Temperature accuracy at 25 °C (77 °F)	± 0.1 °C (± 0.1 °F)

#### Construction

Measuring principle	4-electrode sensor
Electrode material	SS 316L/1.4435 Hastelloy C22
Body material	PEEK
RTD	Built-in Pt1000
Sensor diameter	12 mm
Sensor length	120 mm (4.72"), 225 mm (8.85"), 425 mm (16.73")
Process connection	Pg 13.5, (with InFit series: Tri-Clamp 1.5", Tri-Clamp 2", Cap nut DN 25

#### Design

Temperature compensation	Pt 1000 IEC class A
Cable connection	InPro 7100: Vario Pin (IP 68); InPro 7100 i: AK9
Wetted parts:	– Metals: SS 316L/1.4435 or Hastelloy C22 – Plastics: PEEK (FDA; USP Class VI)

#### Certificates and Approvals

Cell constant, ATEX, Material certificate 2.1 and 3.1, CE

### ISM Features

- Digital connector
- Plug and Measure functionality

### Typical Applications

- Chemical concentration control
- Control of CIP processes
- Control of digesting and bleaching (Pulp & Paper)
- Detection of phase separation (Food & Beverages)
- Buffer preparation (Pharma)

▶ [www.mt.com/InPro7100](http://www.mt.com/InPro7100)

## Ordering Information

### InPro 7100

Sensor	Order Number
InPro 7100/12/120/4435	52 003 571
InPro 7100/12/120/C22_	52 003 572
InPro 7100/12/425/4435	52 003 793
InPro 7100/12/425/C22_	52 003 794

### InPro 7100 i

Sensor	Order Number
InPro 7100i/12/120/4435	52 003 791
InPro 7100i/12/120/C22_	52 003 792
InPro 7100i/12/225/4435	30 095 803
InPro 7100i/12/425/4435	52 003 880
InPro 7100i/12/425/C22_	52 003 881

### Patch Cables

1.5m (5ft)	58 080 201
3.0m (10ft)	58 080 202
4.6m (15ft)	58 080 203
7.6m (25ft)	58 080 204
15.2m (50ft)	58 080 205
22.9m (75ft)	58 080 206
30.5m (100ft)	58 080 207

### AK9 Coax Cables with K8S Connector for ISM sensors

Cable Socket	Termination	Cable Length	Order Number
AK9	Tinned ends	1 m (3.3ft)	59 902 167
AK9	Tinned ends	3 m (9.8ft)	59 902 193
AK9	Tinned ends	5 m (16.4ft)	59 902 213
AK9	Tinned ends	10 m (32.8ft)	59 902 230
AK9	Tinned ends	20 m (65.6ft)	52 300 204

For accessories, cables and cable lengths refer to page 132.

### Measuring Ranges 4-Electrode Design Sensors

Sensors	Transmitters							System Accuracy (±)
	M100	M200	M300	M400 4-W	M400 2-W	M700	M800	
InPro 7108	–	–	0.02–650	0.02–650	0.02–650	0.02–500	0.02–650*	5 %
InPro 7100	–	–	0.02–400	0.02–400	0.02–400	0.02–400	0.02–400*	5 %
InPro 7100i	0.02–500	0.02–500	0.02–500	0.02–500	0.02–500	–	0.02–500	5 %

All values in mS/cm

\* M800 1-channel only

Suitable Housings	p.
InTrac 781 .....	121

## InPro 7250 Inductive Conductivity Sensors



### Features Overview

- Inductive design ideal for dirty applications or process chemical concentration measurement
- No polarization effects
- High temperature model suitable for boiler blowdown applications
- Chemically resistant PEEK body for very aggressive chemicals
- PFA version available for harsh environments
- Robust design for maintenance-free operation
- Available bushings and flanges simplify installation

► [www.mt.com/InPro7250](http://www.mt.com/InPro7250)

The InPro 7250 Series conductivity sensors are inductive sensors designed to handle aggressive chemical solutions or dirty water applications. These “electrodeless” sensors have no electrodes in contact with the sample and are not affected by coatings that foul traditional contacting conductivity sensors. Able to measure medium to very high conductivity levels, applications range from measurement of industrial wastewater to acid, caustic, and salt stream concentration in industrial processing.

### Specifications

High Temperature (HT)	PEEK	PFA
Measurement range	0–2,000 mS/cm	0–2,000 mS/cm
Temperature range	–20 to 180 °C (–4 to 356 °F)	–20 °C to 125 °C (–4 to 257 °F)
Pressure range at 25 °C (77 °F)	0–20 bar (0–290 psi)	0–16 bar (0–232 psi)
Sensor material	PEEK, glass filled	PFA, not glass filled
Seal material	Viton®	PTFE
Temperature sensor	Pt1000	Pt1000
Cell factor	2.175	2.30
Process connection	G ¾"	G ¾"
Cable length	3 m, 5 m, 10 m (9.8 ft, 16.4 ft, 32.8 ft)	3 m, 5 m, 10 m (9.8 ft, 16.4 ft, 32.8 ft)
<b>Certificates and Approvals</b>	ATEX: • FM: • CE: •	• • •

### Standard

Temperature (ST)	PEEK
Measurement range	0–2,000 mS/cm
Temperature range	–20 to 100 °C (–4 to 212 °F)
Pressure range at 25 °C (77 °F)	0–8 bar (0–116 psi)
Sensor material	PEEK, glass filled
Seal material	Viton®
Temperature sensor	Pt1000
Cell factor	2.175
Process connection	G ¾"
Cable length	3 m, 5 m, 10 m (9.8 ft, 16.4 ft, 32.8 ft)
<b>Certificates and Approvals</b>	CE: •

## Ordering Information

Sensors	Order Number
InPro 7250 ST/Pt1000/3 m (9.8 ft)	52 002 736
InPro 7250 ST/Pt1000/5 m (16.4 ft)	52 002 737
InPro 7250 ST/Pt1000/10 m (32.8 ft)	52 002 738
InPro 7250 HT/Pt1000/3 m (9.8 ft)	52 002 739
InPro 7250 HT/Pt1000/5 m (16.4 ft)	52 002 740
InPro 7250 HT/Pt1000/10 m (32.8 ft)	52 002 741
InPro 7250 PFA/Pt1000/3 m (9.8 ft)	52 005 423
InPro 7250 PFA/Pt1000/5 m (16.4 ft)	52 005 424
InPro 7250 PFA/Pt1000/10 m (32.8 ft)	52 005 425

Other sensor cable lengths are available. Please contact METTLER TOLEDO for details.

Process Connections and Accessories	Order Number
<b>– Flanges</b>	
Flange DN 50/PN16	52 403 565
Flange ANSI 2"	52 403 567
Flange ANSI 3"	52 403 569
Flange DN50/PN16, PVDF, only for PFA version	52 403 946
Flange ANSI 2", incl. Sealing Plate PTFE	52 403 947
<b>– Bushings</b>	
Bushing R 1½"	52 403 446
Bushing R 1½", PVDF	52 403 447
Bushing R 2"	52 403 448
Bushing R 2", PVDF	52 403 449
Bushing 1½" NPT	52 403 450
Bushing 1½" NPT, PVDF	52 403 451
Bushing 2" NPT	52 403 452
Bushing 2" NPT, PVDF	52 403 453
<b>– Sanitary Adapters</b>	
Dairy adapter DN50	52 403 583
Aseptic adapter DN50	52 403 584
<b>– InDip 550 Ind – Sensor holder spare part set</b>	
InDip 550ind PVC	52 403 579
InDip 550ind PVDF	52 403 580
<b>– Accessories</b>	
Flat gasket (Viton®)	52 403 432
O-ring (Viton®)	52 750 171
Locknut (stainless steel)	52 403 433

Transmitter M700(x), Module Cond Ind 7700 (x)	Designation	Order Number
Transmitter base, ss (no modules)	M700S	52 121 174
Transmitter base, ss, Ex, VPW*, 100...230 VAC	M700XS/VPW	52 121 175
Transmitter base, ss, Ex, 24 VAC/DC	M700XS/24 V	52 121 176
Transmitter base, coated (no modules)	M700C	52 121 171
Transmitter base, coated, Ex, VPW*, 100...230 VAC	M700XC/VPW	52 121 172
Transmitter base, coated, Ex, 24 VAC/DC	M700XC/24 V	52 121 173

\* VPW = VariPoWer

Conductivity (Inductive) Measurement Module	Designation	Order Number
Conductivity (inductive) measurement module	Cond Ind 7700	52 121 186
Conductivity (inductive) measurement module, Ex	Cond Ind 7700X	52 121 187

Transmitter M400 (4-Wire Transmitter)	Designation	Order Number
M400, Type 1 Cond Ind	–	52 121 495

Transmitter M400 (2-Wire Transmitter)	Designation	Order Number
M400 2XH Cond Ind	–	30 256 307

## Transmitters for All Parameters Your Access to the Process

### Constant information

Transmitters are the components that communicate to the user and translate sensor readings into displayed measurements. METTLER TOLEDO provides tailorable transmitter solutions to meet the needs of a wide range of applications and functional requirements. Intelligent diagnostics keep users informed of sensor "health".

### Single- or multi-channel?

For simpler processes where only a single parameter requires measurement, a single-channel transmitter is the obvious choice, but for processes where more than one parameter must be monitored, multi-channel, multi-parameter transmitters offer

significant advantages. METTLER TOLEDO multi-channel transmitters combine operating flexibility with ease of use.

### Transmitters for hazardous areas

Many of our transmitters have been designed specifically for hazardous



	M200 (p. 80–81)	M300 (p. 82–83)	M400 (p. 84–87)	M800 (p. 90–92)	
	4-Wire				
<b>Channels</b>	1/2	1/2	1	1/2/4*	
<b>Plug and Measure</b>	•	•	•	•	
<b>Dynamic Lifetime Indicator (DLI)</b>	–	•	•	•	
<b>Adaptive Calibration Timer (ACT)</b>	–	•	•	•	
<b>Time To Maintenance (TTM)</b>	–	•	•	•	
<b>Calibration history</b>	–	•	•	•	
<b>CIP/SIP autoclaving counter</b>	–	•	•	•	
<b>iMonitor</b>	–	•	•	•	
<b>Communication</b>	–	–	<b>HART® FOUNDATION fieldbus*</b>	<b>Profinet*</b>	
<b>Panel Cutout</b>	½ DIN, ¼ DIN	½ DIN, ¼ DIN	½ DIN	½ DIN	
<b>Mixed-mode input</b>	–	•	•*	•*	
<b>PID controller</b>	–	•	•	•	
<b>Hold input</b>	•	•	•	•	
<b>Analog input</b>	–	–	1	1	
<b>Digital input</b>	1/2	1/2	2	4/5/6	
<b>Relays/open collectors (OC)</b>	2	2	4	0/8*	
<b>Outputs</b>	2/4	2/4	4	4/8*	
<b>Approvals</b>	UL	UL	<b>ATEX IECEx Zone 2 FM CI 1 Div 2 CSA CI 1 Div 2* NEPSI</b>	<b>FM CI 1 Div 2*</b>	
<b>Parameter compatibility (Ingold)</b>					
<b>pH/ORP/pNa</b>	•	•	•	•	
<b>Dissolved oxygen</b>					
Amperometric sensors					
High (InPro 68xxi)	•	•	•	•	
Low (InPro 69xxi)	–	–	•*	•	
Optical sensors					
High (InPro 68xx)	–	–	•	•	
Low (InPro 69xx)	–	–	•*	•	
<b>Gaseous oxygen</b>					
High (InPro 68xx)	–	–	•*	•	
Low (InPro 69xx)	–	–	•*	•	
GPro 500	–	–	•*	–	
<b>CO<sub>2</sub></b>					
InPro 5000i	–	–	•	•	
InPro 5500i	–	–	•*	•	
<b>Conductivity 2-e/4-e</b>	•	•	•	•	
<b>Inductive conductivity</b>	–	–	•*	–	
<b>Turbidity</b>	–	–	–	•*	
<b>Ozone</b>	•	•	•	–	
<b>EasyClean™ compatibility</b>	•	•	•	•	



area use where there is a risk of explosive or toxic environments. Low-power, 2-wire units with ATEX/FM approvals ensure operating safety.

### Digital communication

We offer transmitters for all common digital communication protocols for easy interface with your DCS or PLC. Intelligent Sensor Management (ISM) diagnostics data can also be accessed

on control systems to provide an overview of the performance of all measurement systems from one point.

### The way forward

Use of digital sensors is becoming increasingly common in the process industries. Many of our transmitters accept traditional analog as well as ISM digital sensors, providing a future oriented investment in your plant.

Our latest transmitter developments include the M400 and M300 Process multi-parameter units. Their touch-screen display and intuitive menus save operating time, while predictive maintenance ensures reliability and reduced maintenance. The M100 series has been designed to provide the ultimate solution for measurement point simplicity. This displayless transmitter sets a new standard in measuring system simplicity and efficiency.



	M100 SM (p. 95)	M100 HM (p. 93)	M100 DR (p. 94)	M400 2(X)H (p. 98–101)	M400 FF (p. 98–101)	M400 PA (p. 98–101)
	<b>2-Wire</b>					
	1	1	1	1	1	1
	•	•	•	•	•	•
	•	•	•	•	•	•
	•	•	•	•	•	•
	•	•	•	•	•	•
	•	•	•	•	•	•
	–	–	–	–	–	–
	BT 4.0 MODBUSRTU	HART®	HART®	HART®	FOUNDATION fieldbus	Profibus PA
	–	–	–	½ DIN	½ DIN	½ DIN
	–	–	–	•	•	•
	–	–	–	•	•	•
	–	•	•	•	–	–
	–	1	1	1	1	1
	–	1	1	2	2	2
	–	–	–	2	–	–
	2	1	1	2	–	–
	–	ATEX IECEx Zone 1 CSA CI 1 Div 1 NEPSI	–	ATEX IECEx Zone 1* FM CI 1 Div 1/2* NEPSI*	ATEX IECEx Zone 1 FM CI 1 Div 1 NEPSI	ATEX IECEx Zone 1 FM CI 1 Div 1 NEPSI
	•	•	•	•	•	•
	•	•	•	•	•	•
	–	•	•	•	•	•
	•	–	–	–	•	•
	–	–	–	–	•	•
	–	–	–	•*	•	•
	–	–	–	•*	•	•
	–	–	–	–	–	–
	•	–	–	–	•	•
	–	–	–	–	–	•
	–	•	•	•	•	•
	–	–	–	•*	–	–
	–	–	–	–	–	–
	–	–	–	–	–	–
	–	–	–	•	•	•

\* Model dependent

## M200: Convenient and Reliable For Basic Process Applications



The M200 multi-parameter transmitter line covers pH, ORP, dissolved oxygen, ozone and conductivity measurements. Plug and Measure provides compatibility and reliable operation for ISM sensors as well as the complete digital easySense™ line. Convenient operation thanks to the large display, plain text interface, quick access menu and easily accessible wiring terminals. With the Transmitter Configuration Tool (TCT) provided for the M200 commissioning as well as maintenance becomes substantially easier.

### Specifications

Measurement parameters	pH, ORP, dissolved oxygen, conductivity and ozone
ISM	Plug and Measure
Power supply	100V to 240VAC or 20 to 30VDC, 10 VA
AC Frequency	50 to 60 Hz
Current (analog) outputs	2 × or 4 × 0/4 – 20 mA, 22 mA alarm, galvanically isolated from input and from earth/ground
User interface	Backlit LCD, 4 lines
Languages	8 (English, German, French, Italian, Spanish, Portuguese, Russian and Japanese)
Ambient temperature	–10 to 50 °C (14 to 122 °F)
Relative humidity	0 to 95 % non-condensing
Rating	IP65
Hold input	yes
Control input	2 (1 for single channel)
Relays	2-SPDT (alarm delay 0 to 999 s)

### Features Overview

- Plug and Measure for easy operation and maintenance
- Input for digital ISM sensor signals and easySense sensors
- Multi-parameter unit
- 1 or 2-channel version
- 2 configurable relays
- IP65 rated
- 8 languages: English, German, French, Italian, Spanish, Portuguese, Russian and Japanese

### Other Highlights

- 4-wire installation
- Quick setup mode for fast commissioning
- Free Transmitter Configuration Tool (TCT) software

► [www.mt.com/M200](http://www.mt.com/M200)

## Parameter Specifications

### pH/ORP

Measurement parameters	pH, mV and temperature
pH range	-2.00 to 16.00 pH
ORP input range	-1500 to 1500 mV
pH resolution	Auto/0.01/0.1/1 (can be selected)
pH accuracy	±1 digit
Temperature measuring range	-30 to 130 °C (-22 to 266 °F)
Temperature resolution	Auto/0.001/0.01/0.1/1 °C/°F (can be selected)
Temperature accuracy	±1 digit
Calibration	1-point (offset), 2-point, process
Sensor maximum distance	80 m (260 ft)

### Dissolved oxygen

Measurement parameters	Dissolved oxygen (DO) saturation or concentration and temperature
DO concentration range	0.00 to 50.00 ppm (mg/L)
DO saturation range	0 to 500 %, air, 0 to 0 to 200 % O <sub>2</sub>
DO resolution	Auto/0.001/0.01/0.1/1 (can be selected)
DO accuracy	±1 digit
Temperature measuring range	-10 to +80 °C (14 to 176 °F)
Temperature resolution	Auto/0.001/0.01/0.1/1 °C/°F (can be selected)
Temperature accuracy	±1 digit
Calibration	1-point (slope or offset), process (slope or offset)
Sensor maximum distance	80 m (260 ft)

### Conductivity

Measurement parameters	Conductivity and temperature
Cond range 2-electrode sensor	0.1 to 40000 mS/cm (25 Ω × cm to 100 MΩ × cm)
Cond range 4-electrode sensor	0.01 to 650 mS/cm (1.54 Ω × cm to 0.1 MΩ × cm)
Cond / Res resolution	Auto/0.001/0.01/0.1/1 (can be selected)
Cond / Res accuracy	± 1 digit
Temperature measuring range	-40 to 200 °C (-40 to 392 °F)
Temperature resolution	Auto/0.001/0.01/0.1/1 °C/°F (can be selected)
Temperature accuracy	±1 digit
Chemical concentration curves	NaCl 0-26 % @ 0 °C to 0-28 % @ +100 °C NaOH 0-12 % @ 0 °C to 0-16 % @ +40 °C to 0-6 % @ +100 °C HCl 0-18 % @ -20 °C to 0-18 % @ 0 °C to 0-5 % @ +50 °C HNO <sub>3</sub> 0-30 % @ -20 °C to 0-30 % @ 0 °C to 0-8 % @ +50 °C H <sub>2</sub> SO <sub>4</sub> 0-26 % @ -12 °C to 0-26 % @ +5 °C to 0-9 % @ +100 °C H <sub>3</sub> PO <sub>4</sub> 0-35 % @ +5 °C to 80 °C TDS ranges NaCl, CaCO <sub>3</sub>
Calibration	1-point (slope), 2-point, process
Sensor maximum distance, DS 4-e	80 m (260 ft)
Sensor maximum distance ISM 2-e	90 m (300 ft)

## Ordering Information

Transmitter	Order Number
M200, ¼ DIN, single-channel	52 121 554
M200, ½ DIN, single-channel	52 121 555
M200, ¼ DIN, dual-channel	52 121 556
M200, ½ DIN, dual-channel	52 121 557

## Accessories

	Order Number
Pipe mounting kit for ½ DIN	30 300 480
Panel mounting kit for ½ DIN	52 500 213
Protective hood	52 500 214
Terminal blocks for M200, M300, M400	52 121 504

Detailed description and order information for easySense sensors and fittings see pages 203–204.

## M300 Process: Versatile and User-Friendly For a Wide Range of Applications and Industries



The multi-parameter M300 Process transmitter line for pH/ORP, dissolved oxygen and conductivity measurements offers exceptional measurement performance as well as excellent user ergonomics.

The high contrast black and white touchscreen together with the harmonized menu structure for all parameters, facilitates navigation and ensures easy and user friendly operation.

On-line diagnostics information allows you to schedule sensor maintenance or replacement. The clearly visible diagnostic information lets you know when it's time to do maintenance or calibration of sensors equipped with Intelligent Sensor Management (ISM) technology.

The integrated USB interface allows you to use it for data logging or to store the configuration on a USB stick.

### Specifications

Power supply	100 to 240 VAC, or 20 to 30 VDC, 10 VA
Frequency for AC	50 to 60 Hz
Current output	2 × 0/4 to 20 mA (4 × for dual channel), 22 mA alarm (according to Namur NE43)
Display	4.0" b/w touchscreen, 320 × 240 pixel
Languages	10 (English, German, French, Italian, Spanish, Portuguese, Russian, Japanese, Korean and Chinese)
Ambient temperature	-10 to 50 °C (14 to 122 °F)
Relative humidity	0 to 95% non-condensing
Rating	¼ DIN: IP65 (front) ½ DIN: IP65
PID controller	Yes
Control input (Hold)	1 or 2 (dual channel version)
Relays	2 × SPDT, 2 × reed
Approvals and certificates	cULus
USB interface	1 × USB Host: Data logging and configuration storage on USB stick 1 × USB Device: Software update interface

### Features Overview

- 4.0" touchscreen
- Multi-parameter transmitter for pH/ORP, O<sub>2</sub> and cond
- Available as single-channel or dual-channel version
- PID controller with pulse length, pulse frequency or analog control
- User management available

### Other Highlights

- Mixed-mode functionality allows the connection of analog or digital ISM sensors
- Full ISM diagnostics available
- 4-wire installation
- Also communicates with EasyClean systems for automatic sensor cleaning

▶ [www.mt.com/M300](http://www.mt.com/M300)

## Parameter Specifications

### pH Performance

Measurement parameters	pH, mV, and temperature
pH, ORP input range*	-1500 to 1500 mV
pH display range	-2 to 16 pH
pH resolution	Auto/0.01/0.1/1 (can be selected)
Relative accuracy**	±0.02 pH; ±1 mV
Temperature input*	Pt1000 (Pt100 with adapter)
Temperature measuring range	-30 to 130 °C (-22 to 266 °F)
Temperature accuracy**	±0.25 °C (±0.45 °F)
Sensor maximum distance	Analog: 10 to 20 m (33 to 65 ft) ISM: 80 m (260 ft)
Calibration	1 or 2 point, process

\* not required for ISM sensors \*\* for analog input signal (ISM signal causes no additional error)

### DO Performance

Measurement parameters	DO saturation or concentration and temperature
Measuring current range	0 to 900 nA
DO concentration range	0.00 to 50.00 ppm (mg/L)
DO accuracy	±0.5% of full scale reading
DO resolution	Auto/0.001/0.01/0.1/1 (can be selected)
Temperature input*	NTC 22
Temperature measuring range	-10 to 80 °C (14 to 176 °F)
Temperature accuracy**	±0.25 °C (±0.45 °F)
Sensor maximum distance	Analog: 20 m (65 ft). ISM: 80 m (260 ft)
Calibration	1-point (slope or offset), process (slope or offset)

\* not required for ISM sensors \*\* for analog input signal (ISM signal causes no additional error)

### Conductivity Performance

Measurement parameters	Conductivity, and temperature
Conductivity/resistivity ranges	2-electrode sensor display range: 0 to 40,000 mS/cm (25 Ω × cm to 100 MΩ × cm) 4-electrode sensor display range: 0.01 to 650 mS/cm (1.54 Ω × cm to 0.1 MΩ × cm)
Temperature input*	Pt 1000
Temperature measuring range	-40 to 200 °C (-40 to 392 °F)
Sensor maximum distance	Analog 2-e: 61 m (200 ft); analog 4-e: 15 m (50 ft) ISM 2-e: 90 m (300 ft); ISM 4-e: 80 m (260 ft)
Cond/Res accuracy**	±0.5% of reading or 0.25 Ω, whichever is greater
Cond/Res repeatability	±0.25% of reading or 0.25 Ω, whichever is greater
Cond/Res resolution	Auto/0.001/0.01/0.1/1 (can be selected)
Temperature resolution	Auto/0.001/0.01/0.1/1 °C (°F) (can be selected)
Temperature accuracy**	±0.25 °C (±0.45 °F)
Temperature repeatability**	±0.13 °C (±0.23 °F)

\* not required for ISM sensors \*\* for analog input signal (ISM signal causes no additional error)

## Ordering Information

### For Analog Sensors

	Order Number
M300 Process, ¼ DIN, single-channel, multi-parameter	30 280 770
M300 Process, ½ DIN, single-channel, multi-parameter	30 280 771
M300 Process, ¼ DIN, dual-channel, multi-parameter	30 280 772
M300 Process, ½ DIN, dual-channel, multi-parameter	30 280 773

### Installation Accessories for ½ DIN Version

	Order Number
Pipe mount kit for ½ DIN	30 300 480
Panel mount kit for ½ DIN	30 300 481
Wall mounting kit for ½ DIN	30 300 482
Protective hood	30 073 328

## M400: Reliable and Intelligent Advanced Process Control



### Features Overview

- 4" touchscreen plus soft-key operation
- Advanced ISM diagnostics, incl. iMonitor
- Communication protocol: 4 to 20 mA (with HART)
- Multi-parameter measurement
- Aluminum die cast enclosure (coated)
- 4-wire installation

The multi-parameter M400 transmitter series features Intelligent Sensor Management (ISM) technology and covers pH/ORP, oxygen (for measurement of dissolved oxygen or in gas), dissolved carbon dioxide, dissolved ozone, conductivity or GPro 500 TDL, depending on the type you choose.

The high-contrast black and white touchscreen together with four soft keys, allows you to operate the transmitter even in the harshest applications without compromising user ergonomics. The online diagnostic information with harmonized menu display lets you know when it is time to do maintenance or calibration of sensors equipped with ISM technology. The HART or FOUNDATION fieldbus communication protocol provides easy integration of sensor diagnostics into process control systems.

### Specifications

#### General

Power supply	100 to 240VAC, or 20 to 30VDC, 10VA
Frequency for AC	50 to 60 Hz
Current output	4 × 0/4 to 20 mA, 22 mA alarm (according to Namur NE43)
Display	4.0" TFT b/w touchscreen, 320 × 240 pixels
Languages	10 (English, German, French, Italian, Spanish, Portuguese, Russian, Japanese, Korean and Chinese)
Ambient temperature	-20 to +50 °C (-4 to 122 °F)
Relative humidity	0 to 95 % non-condensing
Rating	IP66 NEMA 4X
Approvals	Type 1, 2, 3: cCSAus Class I Division 2, ATEX IECEX Zone 2, cFMus Class I Division 2, NEPSI Zone 2 Type 1 Cond Ind: cFMus Class I Division 2, ATEX Zone 2
PID process controller	Yes
Control input (Hold)	2
USB interface	1 × USB Host: Data logging and configuration storage on USB stick 1 × USB Device: Software update interface

### Other Highlights

- Plug and Measure functionality
- IP 66 rated
- Graphic trending
- Transmitter configuration tool



### Did You Know

With tools such as the Dynamic Lifetime Indicator, Time To Maintenance and Adaptive Calibration Timer, ISM technology on the M400 offers true predictive maintenance, resulting in fewer unscheduled shutdowns.

► [www.mt.com/M400](http://www.mt.com/M400)

## Parameter Specifications

### pH/ORP (incl. pH/pNa)

Measurement parameters	pH, mV and temperature
pH display range	-2.00 to +16.00 pH
pH resolution	Auto/0.001/0.01/0.1/1 (can be selected)
pH accuracy <sup>1)</sup>	Analog: $\pm 0.02$ pH
mV range	-1500 to +1500 mV
mV resolution	Auto/0.001/0.01/0.1/1 mV (can be selected)
mV accuracy <sup>1)</sup>	Analog: $\pm 1$ mV
Temperature input <sup>2)</sup>	Pt 1000/Pt 100/NTC 22k
Temperature measuring range	-30 to +140 °C (-22 to +284 °F)
Temperature resolution	Auto/0.001/0.01/0.1/1 (can be selected)
Temperature accuracy <sup>1)</sup>	Analog: $\pm 0.25$ °C ( $\pm 0.45$ °F)
Temperature compensation	Automatic/Manual
Max. sensor cable length	Analog: 10 to 20 m (33 to 65 ft) depending on sensor ISM: 80 m (260 ft)
Calibration	1-point, 2-point or process

1) ISM input signal causes no additional error.

2) Not required on ISM sensors

### Amperometric oxygen

Measurement parameters	Dissolved oxygen (DO): Saturation or concentration and temperature Oxygen in gas: Concentration and temperature
Measuring current range	Analog: 0 to -7000 nA
Oxygen display ranges	Dissolved oxygen Saturation: 0 to 500 % air, 0 to 200 % O <sub>2</sub> -sat Concentration: 0 ppb ( $\mu\text{g/L}$ ) to 50.00 ppm (mg/L) In gas Saturation: 0 to 100 vol-% O <sub>2</sub> Concentration: 0 to 9999 ppb O <sub>2</sub> gas
Oxygen accuracy <sup>1)</sup>	Dissolved oxygen: Saturation $\pm 0.5$ % of the measured value or $\pm 0.5$ %, depending on which is larger. Concentration at high values: $\pm 0.5$ % of the measured value or $\pm 0.050$ ppm/ $\pm 0.050$ mg/L, depending on which is larger. Concentration at low values: $\pm 0.5$ % of the measured value or $\pm 0.001$ ppm/ $\pm 0.001$ mg/L, depending on which is larger In gas: $\pm 0.5$ % of the measured value or $\pm 5$ ppb, depending on which is larger for ppm O <sub>2</sub> gas. $\pm 0.5$ % of the measured value or $\pm 0.01$ %, depending on which is larger for vol-% O <sub>2</sub> .
DO resolution	Auto/0.001/0.01/0.1/1 (can be selected)
Polarization voltage	O <sub>2</sub> High: Cal/Meas: -675 mV (configurable) O <sub>2</sub> Low: Cal: -675 mV, Meas: -500 mV (configurable)
Temperature input	Pt 1000/Pt 100/NTC 22k
Temperature compensation	Automatic
Temperature measuring range	-10 to +80 °C (+14 to +176 °F)
Temperature resolution	Auto/0.001/0.01/0.1/1 °C (°F) (can be selected)
Temperature accuracy <sup>1)</sup>	$\pm 0.25$ °C ( $\pm 0.45$ °F)
Max. sensor cable length	Analog: 20 m (65 ft) ISM: 80 m (260 ft)
Calibration	1-point (slope and offset) or process (slope and offset)

1) ISM input signal causes no additional error.

### Optical oxygen

Measurement parameters	Dissolved oxygen (DO): Saturation or concentration and temperature Oxygen in gas: Concentration and temperature
Oxygen display ranges	Dissolved oxygen Saturation: 0 to 500 % air, 0 to 200 % O <sub>2</sub> -sat Concentration: 0 ppb ( $\mu\text{g/L}$ ) to 50.00 ppm (mg/L) In gas Saturation: 0 to 100 vol-% O <sub>2</sub> Concentration: 0 to 9999 ppb O <sub>2</sub> gas
Oxygen accuracy	$\pm 1$ digit
Oxygen resolution	Auto/0.001/0.01/0.1/1 (can be selected)
Temperature compensation	Automatic
Temperature measuring range	-30 to +150 °C (-22 to +302 °F)
Temperature resolution	Auto/0.001/0.01/0.1/1 °C (°F) (can be selected)
Temperature accuracy	$\pm 1$ digit
Max. sensor cable length	80 m (260 ft)
Calibration	1-point (depending on sensor model) 2-point or process, process scaling

### Dissolved carbon dioxide

Measurement parameters	Dissolved carbon dioxide and temperature
CO <sub>2</sub> display range	0 to 5000 mg/L 0 to 200% sat 0 to 1500 mm Hg 0 to 2000 mbar 0 to 2000 hPa
CO <sub>2</sub> accuracy	± 1 digit
CO <sub>2</sub> resolution	Auto/0.001/0.01/0.1/1 (can be selected)
mV range	-1500 to +1500 mV
mV resolution	Auto/0.01/0.1/1 mV (can be selected)
mV accuracy	± 1 digit
Total pressure range	0 to 4000 mbar
Temperature measuring range	-30 to +150 °C (-22 to +302 °F)
Temperature resolution	Auto/0.001/0.01/0.1/1 °C (°F) (can be selected)
Temperature accuracy	± 1 digit
Max. sensor cable length	80 m (260 ft)
Calibration	1-point (offset), 2-point (slope and offset) or process (offset)

### CO<sub>2</sub> hi (thermal conductivity)

Measurement parameters	Dissolved carbon dioxide and temperature
CO <sub>2</sub> display ranges	0 to 10 bar p (CO <sub>2</sub> )/0 to 145 psi p (CO <sub>2</sub> ) 0 to 15 g/L 0 to 7 V/V CO <sub>2</sub>
Accuracy in fluids <sup>1)</sup>	± 1 % of reading (within ± 5 % of calibration temperature) ± 2 % of reading over temperature range 0 to 50 °C (32 to 122 °F)
Calibration	1-point or process

1) Complete loop of sensor and transmitter

### GPro 500 TDL

Measurement parameters	O <sub>2</sub> , O <sub>2</sub> and temperature, CO (ppm), CO (%) , H <sub>2</sub> O, CO <sub>2</sub> (%), H <sub>2</sub> S, HCl
Gas display ranges	0 to 100 %
Gas accuracy, resolution, repeatability and low detection limit	Depending on sensor model
Linearity	Better than 1 %
Drift	Negligible (< 2 % of measurement range between maintenance intervals)
Sampling rate	1 second
Response time (t <sub>90</sub> )	Depending on sensor model
Process pressure ranges	Depending on sensor model
Process temperature ranges	0 to 250 °C (32 to 482 °F) optional (for probe installation) 0 to 600 °C (32 to 1112 °F) with additional thermal barrier 0 to 150 °C (32 to 302 °F) (white cell)
Max. sensor cable length	40 m (130 ft) (FM version)
Calibration	1-point (offset) or process (slope or offset)

### Dissolved ozone

Measurement parameters	Concentration and temperature
Display range for current	Analog: 0 to -7000 nA
Ozone measuring range	0 to 5000 ppb (µg/L) O <sub>3</sub>
Ozone accuracy	± 1 % (or 0.4 ppb) up to 2000 ppb ± 2.5 % (or 50-125 ppb) from 2000 to 5000 ppb
Resolution	± 1 digit
Temperature compensation	Automatic
Temperature measuring range	5 to +50 °C (+41 to +122 °F)
Temperature resolution	Auto/0.001/0.01/0.1/1 (can be selected)
Temperature accuracy 1)	Analog: ± 0.25 °C (± 0.45 °F)
Max. sensor cable length	80 m
Calibration	1-point (offset) or process (slope and offset)



### Conductivity 2-e/4-e

Measurement parameters	Conductivity/resistivity and temperature
Conductivity ranges	See sensor specification
Chemical concentration curves (used with 4-e sensors)	NaCl: 0–26 % @ 0 °C to 0–28 % @ +100 °C NaOH: 0–12 % @ 0 °C to 0–16 % @ + 40 °C to 0–6 % @ +100 °C HCl: 0–18 % @ –20 °C to 0–18 % @ 0 °C to 0–5 % @ +50 °C HNO <sub>3</sub> : 0–30 % @ –20 °C to 0–30 % @ 0 °C to 0–8 % @ +50 °C H <sub>2</sub> SO <sub>4</sub> : 0–26 % @ –12 °C to 0–26 % @ + 5 °C to 0–9 % @ +100 °C H <sub>3</sub> PO <sub>4</sub> : 0–35 % @ + 5 °C to + 80 °C
TDS ranges	NaCl, CaCO <sub>3</sub>
Cond/Res accuracy <sup>1)</sup>	Analog: ±0.5 % of reading or 0.25 Ω, whichever is greater
Cond/Res repeatability <sup>1)</sup>	Analog: ±0.25 % of reading or 0.25 Ω, whichever is greater
Cond/Res resolution	Auto/0.001/0.01/0.1/1 (can be selected)
Temperature input	PT1000
Temperature measuring range	–40 to +200 °C (–40 to +392 °F)
Temperature resolution	Auto/0.001/0.01/0.1/1 (can be selected)
Temperature accuracy (±0.90 °F) outside	Analog: ±0.25 °C (±0.45 °F) within –30 to +150 °C (–22 to +302 °F); ±0.50 °C
Max. sensor cable length	Analog: 2-e sensors: 61 m (200 ft); 4-e sensors: 15 m (50 ft) ISM: 2-e sensors: 90 m (300 ft); 4-e sensors: 80 m (260 ft)
Calibration	1-point, 2-point or process

1) ISM input signal causes no additional error.

### Ordering information

Transmitter	Order Number
M400 Type 1 ISM	30 490 171
M400 Type 2 ISM	30 490 172
M400 Type 1 Cond Ind	52 121 495
M400 Type 1	30 374 111
M400 Type 2	30 374 112
M400 Type 3	30 374 113
M400 FF 4-wire	30 374 121

### Installation Accessories

	Order Number
Pipe mounting kit for ½ DIN	30 300 480
Panel mount kit for ½ DIN	30 300 481
Wall mounting kit for ½ DIN	30 300 482
Protective hood	30 073 328

### Parameter Fit Guide

	M400 Type 1		M400 Type 2 M400 4-wire FF		M400 Type 3	
	Analog	ISM	Analog	ISM	Analog	ISM
pH/ORP	•	•	•	•	•	•
pH/pNa	–	•	–	•	–	•
UniCond 2-e/4-e	–	•	–	•	–	•
Conductivity 2-e	•	–	•	–	•	–
Conductivity 4-e	•	•	•	•	•	•
Amp. dissolved oxygen ppm/ppb/trace	–	–	•/• <sup>1)</sup> 2)/–	•/• <sup>1)</sup> 2)/–	•/•/•	•/•/•
Opt. dissolved oxygen ppm/ppb	–	–	–/–	•/• <sup>1)</sup>	–/–	•/•
Amp. O <sub>2</sub> gas ppm/ppb/trace	–	–	–/–/–	–/–/–	•/•/•	•/•/•
Opt. O <sub>2</sub> gas ppm	–	–	–	–	–	•
Dissolved ozone	–	–	•	•	•	•
Dissolved carbon dioxide	–	–	•	•	•	•
CO <sub>2</sub> hi	–	–	–	–	–	•
GPro 500 TDL	–	–	–	–	–	•

1) Thornton high performance dissolved oxygen and pure water optical sensors only

2) M400 4-wire FF supports Ingold Amp. DO ppb sensors

## M700: Modular and Adaptive Seamless Integration



The M700 is a multi-parameter transmitter for the process industry. It has a modular design equipped with three module slots so that it is configurable by the user with up to two measurement parameters plus a choice of communications. The transmitter can be configured to suit measurement requirements such as pH/ORP, dissolved oxygen, gas phase oxygen, conductivity and dissolved carbon dioxide. The transmitter has a high resolution backlit graphic display and is IP65/NEMA 4X. Two enclosures are available, one with polished stainless steel for the biopharmaceutical and food and beverage industries and a coated steel version for the chemical and wastewater industries.

### Specifications

#### General

Power supply	24 VAC/DC or 100 to 230 VAC
Frequency for AC	45 to 65 Hz
Module slots	3
Real-time clock	Yes
Enclosure rating	IP 65/NEMA 4X
Enclosure material	M700 S: Polished stainless steel M700 C: Coated steel
Ambient temperature	-20 to 55 °C (-4 to 131 °F)
Relative humidity	10 to 95% non-condensing
Display	Custom graphic backlit LCD
Languages	6 (English, German, French, Italian, Spanish, Swedish)
Measurement recorder	Dual-channel process variables and event marking
Logbook	Records function activations, warning and failure messages with time/date indication
Approvals	ATEX, FM

#### Intelligent Sensor Management (ISM)

ISM functionality allows Plug and Measure and advanced diagnostics. ISM simplifies the installation, handling and maintenance of measurement equipment. For more information see ISM introduction pages 10–11.

### Features Overview

- Measures two parameters with temperature
- Fully configurable by the user
- Fieldbus communication capability
- Supervisor password protection
- High resolution backlit display
- Polished and coated stainless steel enclosures

### Other Highlights

- Easy downloading of software upgrades
- Pipe, panel or wall mounting
- IP 65/NEMA 4X waterproof enclosure
- Real-time clock
- Advanced sensor diagnostics

► [www.mt.com/M700](http://www.mt.com/M700)

## Ordering Information

Transmitters	Designation	Order Number
Transmitter base, ss (no modules)	M700S	52 121 174
Transmitter base, ss, Ex, VPW*, 100...230 VAC	M700XS/VPW	52 121 175
Transmitter base, ss, Ex, 24 VAC/DC	M700XS/24V	52 121 176
Transmitter base, coated (no modules)	M700C	52 121 171
Transmitter base, coated, Ex, VPW*, 100...230 VAC	M700XC/VPW	52 121 172
Transmitter base, coated, Ex, 24 VAC/DC	M700XC/24V	52 121 173

\* VPW = VariPoWer

pH Measurement Modules	Designation	Order Number
pH measurement module, ISM/Analog	pH 2700i	52 121 261
pH measurement module, ISM/Analog, Ex	pH 2700iX	52 121 262

Oxygen Measurement Modules	Designation	Order Number
Oxygen measurement module	O <sub>2</sub> 4700i	52 121 263
Oxygen traces measurement module, Ex	O <sub>2</sub> 4700iX traces	52 121 294

Conductivity Measurement Modules	Designation	Order Number
Conductivity measurement module	Cond 7700	52 121 184
Conductivity measurement module, Ex	Cond 7700X	52 121 185
Conductivity (inductive) measurement module	Cond Ind 7700	52 121 186
Conductivity (inductive) measurement module, Ex	Cond Ind 7700X	52 121 187

Output and Communication Modules	Designation	Order Number
Dual 0/4 to 20 mA output module	OUT 700	52 121 177
Dual 0/4 to 20 mA output module, Ex	OUT 700X	52 121 178
PID controller	PID 700	52 121 179
PID controller, Ex	PID 700X	52 121 180
PROFIBUS PA	PA 700	52 121 210
PROFIBUS PA, Ex	PA 700X	52 121 181
FOUNDATION fieldbus	FF 700	52 121 280
FOUNDATION fieldbus, Ex	FF 700X	52 121 281
EC 700, for EC 400 communication	EC 700	52 121 259
EC 700, for EC 400 communication, Ex	EC 700X	52 121 260

Installation Accessories	Order Number
Pipe mount kit	52 121 208
Panel mount kit	52 121 209

Other Accessories	Order Number
pH sensor simulator	59 906 431
VP simulator	52 120 939

Additional Software Functions	Designation	Order Number
KI recorder	SW 700-001	52 121 198
Current characteristic definable	SW 700-006	52 121 203
High CO <sub>2</sub> compensation (O <sub>2</sub> )	SW 700-011	52 121 250
Temp. compensated ultrapure water (Cond)	SW 700-008	52 121 204
User-defined concentration chart (Cond)	SW 700-009	52 121 205

\* Delivered with audit trail card (P/N 52 121 244). Call for details on software options for the M700

# M800: Multi-Parameter, Multi-Channel Transmitter

## Touch the Future



### Features Overview

- Color touchscreen
- Intuitive operation
- Premium ISM functionality
- Multi-parameter measurement
- 1-/2-/4-channel versions
- iMonitor™
- User management and logbook

### Other Highlights

- 8 current outputs
- 8 output relays
- Traffic light coded sensor information
- IP 66 rated
- 2 PID process controllers

► [www.mt.com/M800](http://www.mt.com/M800)

The M800 transmitter series features premium Intelligent Sensor Management (ISM) technology measuring pH/ORP, optical DO, amperometric oxygen (DO as well as O<sub>2</sub> gas), dissolved carbon dioxide, turbidity and conductivity. The multi-parameter transmitter accepts any compatible combination of ISM sensors. Up to four channels of process measurement provides immediate Plug and Measure installation and operation, predictive sensor maintenance and dynamic lifetime status. The color touchscreen ensures intuitive operation, with user selectable control and alarm management.

### Specifications

#### General Specification

Measurement parameters	pH/ORP, amperometric and optical oxygen, conductivity, dissolved carbon dioxide, turbidity and temperature
ISM	Plug and Measure, advanced diagnostics (Dynamic Lifetime Indicator, Adaptive Calibration Timer, CIP/SIP counter etc.), iMonitor
Power supply	100 to 240VAC, or 20 to 30VDC, 12 VA
AC frequency	50 to 60Hz
Current (analog) outputs <sup>1)</sup>	8 × 0/4 to 20 mA, 22 mA alarm
User interface	Color touchscreen 5.7", resolution 320 × 240 px, 256 colors
Languages	10 (English, German, French, Italian, Spanish, Portuguese, Russian, Japanese, Korean and Chinese)
Ambient temperature	-20 to 50 °C (-4 to 122 °F)
Relative humidity	0 to 95 %, non-condensing
Rating	IP 66
PID process controller	2
Control input (Hold)	Yes
Analog input	Yes
Alarm contact	Yes (alarm delay 0 to 999 s)
Measuring range	Parameter and sensor depending
Measuring accuracy	± 1 digit (sensor depending)
Measuring repeatability	± 1 digit (sensor depending)
Measuring resolution	Auto/0.001/0.01/0.1/1 (can be selected)

1) Not supported on Profinet model.

### Did You Know

The M800 1-channel transmitter with mixed mode functionality supports analog and digital ISM sensors.

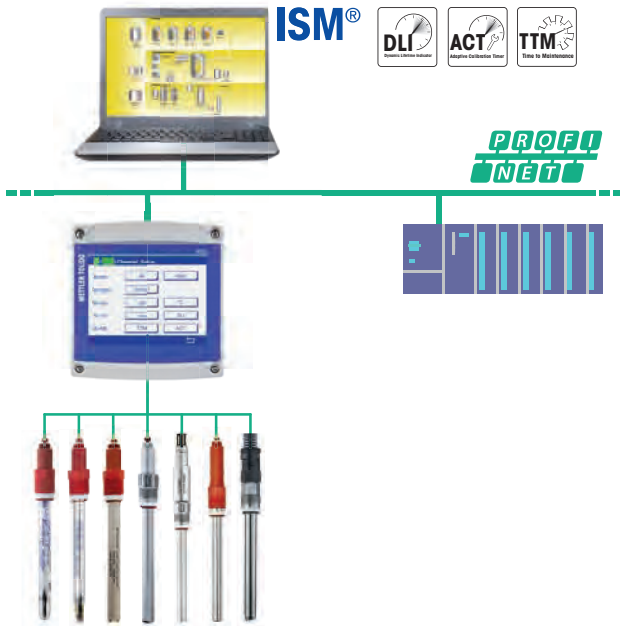

M800 Profinet series is multi-parameter transmitter featuring Intelligent Sensor Management technology. It covers ISM sensors for pH/ORP, optical DO, amperometric oxygen (DO as well as O<sub>2</sub> gas), dissolved carbon dioxide and conductivity, provide all ISM measurements and diagnostics information to a centralized control system for data management including predictive diagnostics. It has 1-channel and 2-channel models. Besides the intuitive operation and alarm management that provided by exist M800, the Profinet interface provides easy integration of sensor diagnostics tools into process control systems, minimum commissioning time and engineering support, saves the integration efforts and costs.

Pure digital communication within loop and real-time measurements, sensor diagnostics and monitoring provides greater process reliability, lower maintenance costs.

**Profinet Specifications**

Data transmission rate	10/100 MBd
Connector	RJ45, M12 optional
IP address	DCP(default) or configuration via menu

**Other Highlights**

- Pure digital communication within loop and real-time sensor aging monitoring provides greater process reliability
- Easy integration of measurement and diagnostics data from the sensor up to the process control level
- Advanced diagnostic settings for efficient and reliable plant management

**M800 Profinet Parameter fit guide**

Version	Process 1-ch	Process 2-ch
Part no.	30 530 021	30 530 022
<b>pH/ORP</b>	•	•
<b>pH/pNa</b>	•	•
<b>UniCond 2e/4e</b>	•	•
<b>Cond 4e</b>	•	•
<b>Amp. DO ppm/ppb/trace</b>	•/•/•*	•/•/•*
<b>Amp. O<sub>2</sub> gas ppm/ppb/trace</b>	•/•/•*	•/•/•*
<b>Optical DO</b>	•**	•**
<b>Dissolved Carbon Dioxide</b>	•	•
<b>CO<sub>2</sub> hi (thermal conductivity)</b>	•**	•**
<b>Dissolved O<sub>3</sub></b>	–	–
<b>Flow</b>	–	–

\* INGOLD sensors

\*\* One optical DO or thermal conductivity CO<sub>2</sub> sensor can be used together with 2-channel transmitter.

## Ordering Information

Transmitters	Order Number
M800 Process 1-channel	30 026 633
M800 Process 2-channel	52 121 813
M800 Process 4-channel	52 121 853
M800 1-channel, stainless steel enclosure	30 246 551
M800 2-channel, stainless steel enclosure	30 246 552
M800 4-channel, stainless steel enclosure	30 246 553
M800 Profinet 1-channel Process	30 530 021
M800 Profinet 2-channel Process	30 530 022

## Installation Accessories

Installation Accessories	Order Number
Pipe mounting kit for 1/2 DIN	30 300 480
Panel mounting kit	52 500 213
Protective hood	30 073 328

## Parameter Fit Guide

Description	Analog Sensors (M800 1-channel only)	ISM Sensors
M800 Process 1-channel / 2-channel / 4-channel	pH/ORP, Cond 2-e/4-e Amp. DO (high), Amp. O <sub>2</sub> Gas (high), Turbidity (backscatter)	pH/ORP, UniCond 2-e, Cond 4-e, Amp. DO (high/low/trace), Amp. O <sub>2</sub> Gas (high/low), Optical DO*, CO <sub>2</sub> high*, CO <sub>2</sub> Turbidity (only M800 1-channel)

\* One (two) optical DO or thermal conductivity CO<sub>2</sub> sensor(s) can be used with 2-channel (4-channel) transmitter.

## M800 parameter fit guide for 2-channel and 4-channel versions

These versions are compatible with the following (digital) ISM sensors.

Parameter	Process 1)	
	2-channel	4-channel
pH/ORP	•	•
pH/pNa	•	•
UniCond 2-e	•	•
Conductivity 4-e	•	•
Amp. dissolved oxygen ppm/ppb/trace	•/•/• <sup>2)</sup>	•/•/• <sup>2)</sup>
Amp. oxygen gas ppm/ppb/trace	•/•/• <sup>2)</sup>	•/•/• <sup>2)</sup>
Optical dissolved oxygen	• <sup>2), 3)</sup>	• <sup>2), 3)</sup>
Dissolved carbon Dioxide (InPro 5000 i)	•	•
CO <sub>2</sub> hi (InPro 5500 i)	• <sup>3)</sup>	• <sup>3)</sup>
TOC/Dissolved ozone/Flow	-/-/-	-/-/-

1) Process models are provided in polycarbonate or stainless steel housing or stainless steel housing. 2) Ingold sensors.

3) 2-channel: An opt. dissolved sensor or a CO<sub>2</sub> hi sensor has to be connected to channel 2. 4-channel: Optical dissolved sensors and CO<sub>2</sub> hi sensors have to be connected to channel 2 and/or to channel 4.

## M800 parameter fit guide for 1-channel

This version is compatible with the following (digital) ISM and analog sensors.

Parameter	Process 1)	
	Analog	ISM
pH/ORP	•	•
pH/pNa	-	•
UniCond 2-e/UniCond 4-e	-/-	•/•
Conductivity 2-e/Conductivity 4-e	•/•	-/•
Amp. dissolved oxygen ppm/ppb/trace	•/•/• <sup>2)</sup>	•/•/• <sup>2)</sup>
Amp. oxygen gas ppm/ppb/trace	•/•/• <sup>2)</sup>	•/•/• <sup>2)</sup>
Optical dissolved oxygen	-	• <sup>2)</sup>
Dissolved carbon dioxide (InPro 5000 i)	-	•
CO <sub>2</sub> hi (InPro 5500 i)	-	•
Turbidity	• (backscatter)	•

1) Process models are provided in polycarbonate or stainless steel housing or stainless steel housing. 2) Ingold sensors.

# M100 Head Mount: Compact and Robust

## Small Footprint Installation for Hazardous Areas



The M100 Head Mount (HM) is a single-channel, multi-parameter transmitter compatible with ISM sensors for measuring pH/ORP, pH/pNa, oxygen and conductivity. Thanks to its compact head mount design the M100 HM 2-wire requires only a small footprint in the plant. With its explosion proof/flameproof enclosure and intrinsically safe electronics the M100 HM offers the most versatile measurement solution for both hazardous and non-hazardous area installation. Featuring ISM functionality the M100 HM greatly reduces maintenance efforts, resulting in significant cost savings. Carrying the HART protocol the M100 HM allows easy transmitter configuration and integration of sensor diagnostics into asset management platforms.

### Specifications

General	
Supply voltage	14 to 30VDC
Number of outputs	1 × 4 to 20mA (loop powered)
Ambient temperature	-20 to 60 °C (-4 to 140 °F)
Relative humidity	0 to 95 % non-condensing
Enclosure rating	IP 66/NEMA 4X
Housing material	Stainless steel
Approvals	<b>M100 HM/2XH:</b> ATEX/IECEx Zone 1, CSA Class I; II, III Div 1, Class 1, Zone 0, NEPSI Ex Zone 1
Hold input	Yes
Analog input	Yes
Communication	HART
Asset management tool compatibility	AMS versions 10 and 11, Simatic™ PDM version 6/8, FDT frame applications

### Features Overview

- CSA approval
- Explosion proof/flameproof housing (a barrier is required)
- Intrinsically safe
- Multi-parameter unit
- HART communication
- IP 66/NEMA 4X rated
- Configuration via asset management tools

### ISM Highlights

- Plug and Measure functionality
- CIP/SIP/Autoclaving counter
- Dynamic Lifetime Indicator
- Adaptive Calibration Timer
- Easy installation and fast commissioning



### Did You Know

The support of all major asset management tools through the M100 ensures maximum compatibility, and easy integration of sensor diagnostics.

## M100 DIN Rail: High Performance and Minimal Space Requirement Compact Design for Simplified Installation



The M100 DIN Rail (DR) is a single-channel, 2-wire multi-parameter transmitter with HART communication capability for analytical measurements. It is compatible with ISM sensors for measuring pH/ORP, pH/pNa, oxygen and conductivity. The ISM's Plug and Measure feature minimizes the risk of installation troubles and simplifies sensor handling and LEDs clearly indicate transmitter and sensor status, alarms, and warnings.

Thanks to its compact design the M100 DR requires only a small installation space in the plant.

The transmitter configuration and integration of sensor diagnostics into asset management tools is possible thanks to the integrated HART protocol. The support of all major asset management tools ensures maximum compatibility and easy integration of sensor diagnostics.

### Specifications

#### General

Supply voltage	14 to 30VDC
Number of outputs	1 × 4 to 20 mA (loop powered)
Ambient temperature	- 10 to 60 °C (14 to 140 °F)
Relative humidity	0 to 95 % non-condensing
Enclosure rating	IP 20
Housing material	PA-FR
Hold input	Yes
Analog input	1 × 4 to 20 mA (for pressure compensation)
Communication	HART
Asset management tool compatibility	AMS versions 10, 11, 12, Simatic 6,8x, FDT frame applications

### Features Overview

- DIN rail mounting, suitable for 35 mm wide DIN rail systems
- Compact housing, 22.5 mm width
- Displayless
- Multi-parameter transmitter
- 1 analog output (4 to 20 mA with HART)
- HART communication as standard
- Configuration via HART handheld or other HART asset management tools

### ISM Highlights

- Plug and Measure functionality
- Dynamic Lifetime Indicator
- Adaptive Calibration Timer
- Time To Maintenance
- CIP/SIP/Autoclaving counter
- Easy installation and fast commissioning

► [www.mt.com/M100](http://www.mt.com/M100)



## M100 Sensor Mount Transmitter: Digital Sensor Integration for Analog and Digital Biocontrollers Smallest Footprint for Simplified Installation



The M100 Sensor Mount (SM) is a single-channel, multi-parameter transmitter. It allows the connection on biocontrollers of 1-wire ISM sensors for measuring pH, ampDO and CO<sub>2</sub> or ISM RS 485 optical oxygen sensors. The M100 SM has a Bluetooth 4.0 interface which is compatible with the PC-based and mobile versions of iSense software. Two independent interfaces are implemented: two configurable 4/20 mA analog outputs and one digital MODBUS RTU. LEDs clearly indicate sensor status, alarms and warnings. ISM's Plug and Measure feature minimizes the risk of installation trouble and simplifies sensor handling.

### Specifications

ISM features	Plug and Measure, DLI, ACT, TTM
Enclosure	IP67
Mounting	On head of 1-wire sensor: AK9 On head of RS485 sensor: VP8
Supply voltage	24 VDC
Analog output	Active 2 × 4 to 20 mA, galvanically isolated to passive DCS card
Communication	Wireless: BT 4.0 iSense PC-based and iSense mobile (Android, iOS) Wired: Digital interface RS485 MODBUS RTU
Sensor compatibility	ISM 1-wire pH, amperometric DO and carbon dioxide sensors. ISM RS485 optical DO sensors

### Features Overview

- Configurable alarms
- Device naming
- MODBUS communication
- ISM functionality
- Multi-parameter unit
- Configuration via iSense/iSense Mobile
- Process calibration with iSense/iSense mobile or MODBUS
- Color LED indication of sensor status
- Intuitive operation with iSense
- iMonitor

### Other Highlights

- CIP/SIP counter
- Dynamic Lifetime Indicator
- Adaptive Calibration Timer
- Easy installation
- Error-free operation: configuration stored in transmitter
- Electronic Data Management with iSense

## M80 Sensor Mount Transmitter

### ISM Solution for Benchtop Controllers



The M80 Sensor Mount (SM) Transmitter is a compact single-channel, multi-parameter transmitter designed especially for biocontroller manufacturers. Its small footprint allows mounting on ISM sensors used in benchtop bioreactors with a typical volume of 1–20 liters. A MODBUS RTU interface enables straightforward and digital integration of sensor measurement data, ISM diagnostic information, and calibration routines into the biocontroller firmware. In addition, visualization of ISM features on the controller’s graphical user interface becomes possible. The M80 SM is compatible with METTLER TOLEDO pH/ORP, amperometric dissolved oxygen, dissolved CO<sub>2</sub>, and conductivity sensors.

#### Specifications

ISM	Plug and Measure, DLI, ACT, TTM
Power supply	24 VDC (min. 100 mA), 8–30 VDC (min. 2 W)
Operating temperature	–15 to +60 °C (5 to 140 °F)
Relative humidity	5 ... 95 % rH (non-condensing)
Mounting	AK9 connector on head of 1-wire sensor
Cable connection	M12/5-pin for RS485 interface and power supply
Communication	MODBUS RTU protocol
Dimensions	Height: 94 mm (3.7"), Maximum diameter: 22 mm (0.87")
Protection class	IP65

#### Features Overview

- Small footprint on bioreactor head plate
- Enables ISM functionality in biocontroller software
- Access to sensor calibration routines via the biocontroller
- No sensor configuration necessary due to internal storage of installation point specific data (MODBUS parameters)
- Trouble-free sensor integration thanks to Plug and Measure
- Configurable with M80 SM Transmitter Configuration Tool PC software and Transmitter Configuration Box

#### Other Highlights

- Robust digital sensor integration
- Ideal for ISM solutions in R&D environment and down-scaling applications
- Pre-batch sensor diagnostics for more robust processes
- Enables electronic traceability of sensors used in different batches
- Less electronic waste compared to pH sensors with permanently integrated transmitter electronics



### Parameter Fit guide

Parameter	M100 HM/2XH	M100 DR	M100 SM 1-wire	M100 SM RS485	M80 SM
pH/ORP	•	•	•	–	•
pH/pNa	•	•	•	–	–
Conductivity 4-e	•	•	–	–	•
Amp. DO ppm/ppb/trace	•/•/•	•/•/•	•/•/•	–	•/–/–
Opt. DO ppm	–	–	–	•	–
Amp. O <sub>2</sub> gas ppm	•	–	–	–	–
Dissolved carbon dioxide	–	–	•	–	•

### Ordering Information

Transmitter	Order Number
M100 HM/2XH M20, 1-channel multi-parameter	30 026 578
M100 HM/2XH NPT ¾", 1-channel multi-parameter	30 246 352
M100 DR/2H, 1-channel multi-parameter	30 127 720
M100 SM, 1-wire	30 365 366
M100 SM, RS485	30 365 367
M80 SM Transmitter	30 530 566

Accessories	Order Number
iSense	30 130 614
iSense CFR	30 283 620
iSense dongle	30 371 387
iLink Multi	30 130 631
iLink Multi cable/set oDO (RS485)	30 355 582
M100SM adapter and power supply	30 404 002
CalBox (upgraded with temperature sensor)	52 300 400
Transmitter Configuration Box (cable set included) (M80)	30 530 567
5-pin data cable 2 m (6.6 ft)	52 300 379
5-pin data cable 5 m (16.4 ft)	52 300 380
5-pin data cable 10 m (32.8 ft)	52 300 381

## M400 2-Wire: Reliable and Intelligent For Hazardous and Non-Hazardous Area Applications



The M400 2-wire, single-channel, multi-parameter transmitter for pH/ORP, dissolved oxygen, gas phase oxygen, conductivity and dissolved carbon dioxide provides highest reliability and process safety in hazardous and non-hazardous area environments. Advanced ISM functionality enables predictive maintenance resulting in reduced operating costs and helps to improve productivity. The HART, FOUNDATION fieldbus (FF) or PROFIBUS PA interface provides easy integration of sensor diagnostics tools into process control systems.

### Specifications

#### General

Display	Backlit LCD, 4 lines
Languages	8 (English, German, French, Italian, Spanish, Portuguese, Russian and Japanese)
Ambient temperature	-20 to 60 °C (-4 to 140 °F)
Relative humidity	0 to 95 % non-condensing
Enclosure rating	IP 66/NEMA 4X
Housing material	Aluminum die cast

#### Certificates and Approvals

<b>M400/2H:</b>	FM cFmus Cl.I Div.2
<b>M400(G)/2XH:</b>	ATEX/IECEx Zone 1, FM cFmus Cl.I Div.1 NEPSI Ex Zone 1, TIIS, KCS
<b>M400FF:</b>	ATEX / IECEx Zone 1, FM cFmus Cl.I Div.1 NEPSI Ex Zone 1
<b>M400PA:</b>	ATEX / IECEx Zone 1, FM cFmus Cl.I Div.1 NEPSI Ex Zone 1

PID process controller	Yes (except M400 PA)
Analog input	Yes

#### 4 to 20 mA with HART

Power voltage	14 to 30 VDC
Number of outputs	2 x 4 to 20 mA (loop powered)
Hold input	Yes
Alarm contact	Yes (alarm delay 0 to 999 s)
Asset management tool compatibility	AMS versions 10 and 11, Simatic PDM version 6/8, FDT frame applications

#### Fieldbus Interface

Current	22 mA
Max. current in case of fault (FDE)	<28 mA
Number of current inputs	1 for pressure compensation
Supply voltage	<b>Non-hazardous area (Non-IS):</b> 9 to 32 VDC <b>Linear Barrier:</b> 9 to 24 VDC <b>FISCO:</b> 9 to 17.5 VDC

#### PROFIBUS PA

Physical interface	According to ICE 61 158-2
Profile	PROFIBUS PA 3.02
ITK version	6.0.1

#### FOUNDATION fieldbus

Profile	FF_H1
---------	-------

### Features Overview

- NEPSI Ex/ATEX/FM approved
- Mixed-mode input (analog or ISM sensors accepted)
- Multi-parameter unit
- 4 to 20 mA (with HART) or FOUNDATION fieldbus version or PROFIBUS PA
- Compatible with ODO sensors
- IP 66/NEMA 4X rated

### Other Highlights

- Plug and Measure functionality
- CIP/SIP/Autoclaving counter
- Dynamic Lifetime Indicator
- Adaptive Calibration Timer
- Quick set up mode for fast installation

► [www.mt.com/M400-2wire](http://www.mt.com/M400-2wire)

**Parameter Specifications****pH, pH/pNa and ISFET Performance**

Measurement parameters	pH, mV, and temperature
pH, ORP input range*	-1500 to 1500 mV
pH display range	-2 to 16 pH
Resolution	0.001/0.01/0.1/1 (can be selected)
Relative accuracy	±0.02 pH; ±1 mV
Temperature input	Pt 1000, Pt 100, NTC 22 kΩ
Temperature compensation	Automatic/manual
Temperature measuring range	-30 to 130 °C (-22 to 266 °F)
Temperature resolution	0.001/0.01/0.1/1 °C/°F (can be selected)
Temperature measurement error*	±0.25 °C (±0.45 °F)
Max. length sensor cable	analog: 20 m (65 ft), depending on sensor; ISM 80 m (260 ft)
Calibration	1 or 2 point calibration, process calibration

\* For analog input signal (ISM input signal causes no additional error)

**Oxygen Performance**

Measurement parameters	- Dissolved oxygen: Saturation or concentration and temperature - Oxygen in gas: Concentration and temperature
Current range	0 to 7000 nA
Oxygen measuring ranges	- Dissolved oxygen: Saturation 0 to 500 % air, 0 to 200 % O <sub>2</sub> Concentration 0.1 ppb (µg/L) to 50.00 ppm (mg/L) - In gas: 0 to 9999 ppm O <sub>2</sub> gas, 0 to 100 Vol-% O <sub>2</sub>
Oxygen accuracy*	
- Dissolved oxygen saturation	±0.5 % of the measured value or ±0.5 % air, whichever is greater. Concentration at high values: ±0.5 % of the measured value or ±0.050 ppm/±0.050 mg/L, whichever is greater. Concentration at low values: ±0.5 % of the measured value or ±0.001 ppm/±0.001 mg/L, whichever is greater.
- In gas:	±0.5 % of the measured value or ±5 ppb, whichever is greater for ppm O <sub>2</sub> gas. ±0.5 % of the measured value or ±0.01 %, whichever is greater for Vol-% O <sub>2</sub> .
Resolution current	6 pA
Polarization voltage	- 1000 to 0 mV for analog sensors - 550 mV or - 674 for ISM sensors (configurable)
Temperature input	Pt 1000
Temperature compensation	Automatic
Temperature measuring range	-30 to 150 °C (-22 to 302 °F)
Temperature accuracy*	±0.25 K in the range of -10 to +80 °C (14 to +176 °F)
Max. length sensor cable	analog: 20 m (65 ft); ISM 80 m (260 ft)
Calibration	1-point (slope or offset) calibration, process calibration (slope or offset) calibration

\* For analog input signal (ISM input signal causes no additional error)

**Conductivity Performance**

Measurement parameters	Conductivity, and temperature
Conductivity ranges (2-e/4-e)	2-electrode sensor: 0.02 to 2000 µS/cm (500 Ω × cm to 50 MΩ × cm) 4-electrode sensor: 0.01 to 650 mS/cm (1.54 Ω × cm to 0.1 MΩ × cm)
Temperature input	Pt 1000
Temperature measuring range	-40 to 200 °C (-40 to 392 °F)
Max. length sensor cable	60 m (196.9 ft) with 2-electrode sensor, 15 m (50 ft) with 4-electrode sensor 80 m (260 ft) with ISM sensor
Cond/Res accuracy*	±0.5 % of reading or 0.25 Ω, whichever is greater, up to 18 MΩ × cm
Cond/Res repeatability*	±0.25 % of reading or 0.25 Ω, whichever is greater
Cond/Res resolution	0.001/0.01/0.1/1 (can be selected)
Temperature resolution	0.001/0.01/0.1/1 °C/°F (can be selected)
Temperature accuracy*	±0.25 °C (±0.45 °F)
Temperature repeatability*	±0.13 °C (±0.23 °F)
Chemical concentration curves	NaCl, NaOH, HCl, HNO <sub>3</sub> , H <sub>2</sub> SO <sub>4</sub> , H <sub>3</sub> PO <sub>4</sub> User-defined concentration table (5 × 5 matrix) TDS ranges NaCl, CaCO <sub>3</sub>
Calibration	1 or 2 point calibration, process calibration

\* For analog input signal (ISM input signal causes no additional error)

## Parameter Specifications (continued)

### Optical Oxygen Performance

Measurement parameters	DO saturation or concentration and temperature
DO saturation range	0 to 500%, 0 to 100% O <sub>2</sub>
DO resolution	Auto/0.001/0.01/0.1/1 (can be selected)
DO accuracy	± 1 digit
Temperature resolution	Auto/0.001/0.01/0.1/1 °C (°F) (can be selected)
Temperature accuracy	± 1 digit
Temperature compensation	Automatic
Max. length sensor cable	15 m (50 ft)
Calibration	1 point (depending on sensor model), 2 point, process calibration

### Dissolved Carbon Dioxide Performance

Measurement parameters	Dissolved carbon dioxide and temperature
Dissolved carbon dioxide range	0 to 5000 mg/L, 0 to 200% sat, 0 to 1500 mmHg, 0 to 2000 mbar, 0 to 2000 hPa
mV range	-1500 to 1500 mV
Total pressure range	0 to 4000 mbar
Dissolved carbon dioxide accuracy	± 1 digit
Resolution	Auto/0.001/0.01/0.1/1 (can be selected)
Temperature range	-30 to 150 °C (-22 to 302 °F)
Temperature resolution	Auto/0.001/0.01/0.1/1 °C/°F (can be selected)
Temperature accuracy	± 1 digit
Temperature repeatability	± 1 digit
Max. length sensor cable	80 m (260 ft)
Calibration	1 or 2 point calibration, process calibration

### Inductive Conductivity (M400 Cond Ind transmitter only)

Measurement parameters	Conductivity and temperature
Display range	0 to 2,000 mS/cm
Chemical concentration curves	NaCl: 0-26% @ 0°C to 0-28% @ +100°C NaOH-1: 0-13% @ 0°C to 0-24% @ +100°C NaOH-3: 15-50% @ 0°C to 35-50% @ +100°C HCl-1: 0-18% @ -20°C to +50°C HCl-2: 22-39% @ -20°C to +50°C HNO <sub>3</sub> -1: 0-30% @ -20°C to +50°C HNO <sub>3</sub> -2: 35-96% @ -20°C to +50°C H <sub>2</sub> SO <sub>4</sub> -1: 0-26% @ -12°C to 0-37% @ +100°C H <sub>2</sub> SO <sub>4</sub> -2: 28-88% @ 0°C to 39-88% @ +95°C H <sub>2</sub> SO <sub>4</sub> -3: 94-99% @ -12°C to 89-99% @ +95°C H <sub>3</sub> PO <sub>4</sub> : 0-35% @ +5°C to +80°C User-defined concentration table (5 × 5 matrix)
TDS ranges	NaCl, CaCO <sub>3</sub>
Conductivity accuracy	± 1.0% of reading or ± 0.005 mS/cm
Conductivity repeatability	± 1.0% of reading or ± 0.005 mS/cm
Conductivity resolution	Auto/0.001/0.01/0.1/1 (can be selected)
Temperature input	PT1000/PT100/NTC22K
Temperature measuring range	-40 to +200 °C (-40 to +392 °F)
Temperature resolution	Auto/0.001/0.01/0.1/1 (can be selected)
Temperature accuracy	± 0.25 K (± 0.45 °F) within -30 to +150 °C (-22 to +302 °F); ± 0.50 K (± 0.90 °F) outside
Temperature repeatability	± 0.13 K (± 0.23 °F)
Max. sensor cable length	10 m (32.8 ft)
Calibration	1-point, zero point or process

### Ordering Information

Transmitter	Order Number
M400/2H, 1-channel multi-parameter	30 025 514
M400/2XH, 1-channel multi-parameter	30 025 515
M400/2XH 1-channel Cond Ind	30 256 307
M400G/2XH, 1-channel multi-parameter	30 025 516
M400FF, 1-channel multi-parameter	30 026 616
M400PA, 1-channel multi-parameter	30 026 617

### Accessories

Accessories	Order Number
Pipe mounting kit for 1/2 DIN	30 300 480
Panel mounting kit for 1/2 DIN	52 500 213
Protective hood	52 500 214

### Transmitter Fit Guide

Parameter	M400/2(X)H		M400 2XH Cond Ind	M400G/2XH		M400FF		M400PA	
	Analog	ISM	Analog	Analog	ISM	Analog	ISM	Analog	ISM
pH/ORP	•	•	–	•	•	•	•	•	•
Conductivity 2-e	•	–	–	•	–	•	–	•	–
Conductivity 4-e	•	•	–	•	•	•	•**	•	•**
Amp. DO* ppm/ppb/trace	•/•/•	•/•/•	–	•/•/•	•/•/•	•/•/•	•/•/•	•/•/•	•/•/•
Amp. O <sub>2</sub> gas	–	–	–	•	•	•	•	•	•
Optical oxygen ppm/ppb	–	•/•	–	–	•/•	–	•/•	–	•/•
Dissolved carbon dioxide (low)	–	•	–	–	•	–	•	–	•
Inductive conductivity	–	–	•	–	–	–	–	–	–

\* Ingold and Thornton sensors

\*\* Ingold sensors

## iSense

### Maximum Performance of ISM Sensors



ISM®

**21 CFR Part 11  
& Annex 11 ready**

iSense CFR is technically compliant with 21 CFR Part 11 and EudraLex Volume 4 Annex 11.

iSense offers a unique means to optimize the performance of pH electrodes, oxygen and carbon dioxide sensors for enhanced reliability and process safety. Simply connect your ISM sensor via USB or Bluetooth to your PC and get access to various intuitive analysis, calibration and documentation applications. Pre-calibrate your ISM sensor with the accuracy of lab conditions and assess the sensor state with real-time diagnostic information. This allows you to decide instantly whether to re-use or discard a sensor. Calibration information is collected, managed and analyzed efficiently and documented consistently to satisfy regulatory requirements.

#### Specifications

##### Performance

Measurement parameters	<b>pH</b>	all digital ISM sensors
	<b>Oxygen</b>	all digital ISM sensors
	<b>CO<sub>2</sub></b>	InPro 5000 i

pH calibration	1-point, 2-point, 3-point, process
DO calibration for amp. sensors	1-point, process
DO calibration for optical sensors	1-point, 2-point, scaling
CO <sub>2</sub> (InPro 5000 i) calibration	1-point, 2-point, process
M100 SM settings	Yes
Sensor field calibration dataset	Yes
Sensor database	Yes
Database backup	Yes
Key performance indicators (KPI)	Yes

##### Recommended PC requirements

Processor	iCore™
RAM	4 GB
Screen resolution	1280 × 1024 or higher
Hard disk	250 M B available space
Operating system	MS-Windows 7/8/8.10 (at least XP SP3 or later)
Interface	USB and/or Bluetooth™ (depending on the accessory)

#### Features Overview

- Automatic PDF protocols with sensor registration/calibration/adjustments/deactivation
- Protocols of field calibration
- Full sensor history
- Database export for further analysis

#### Other Highlights

- Intuitive Windows™ interface
- Early detection of worn-out sensors
- Comprehensive, at a glance sensor status analysis

► [www.mt.com/iSense](http://www.mt.com/iSense)



## Ordering Information

Description	Order Number
iSense	30 130 614
iSense CFR	30 283 620

Accessories	Order Number
iLink Multi (with integrated barometer and hygrometer)	30 130 631
iLink Multi Cable/Set oDO (RS485) (required cable set for optical oxygen sensors connecting with iLink Multi)	30 355 582
AK9/1m/BNC-50 (required cable set for pH, CO <sub>2</sub> and amperometric oxygen sensors connecting with iLink Multi)	59 902 168
CalBox with temperature sensor for iLink Multi	52 300 400
iSense BT Dongle (wireless connection to M100 SM and J-Box BT)	30 371 387
Cable DS AK9-RJ12 (connects 1-wire sensors to iSense)	52 300 383
iLink RS485 VP	30 014 134
iLink RS485	52 300 399
iLink 1-wire BT (Bluetooth dongle with rechargeable battery)	30 126 791



**iLink Multi** is a universal device for connecting digital ISM sensors (1-wire; RS485) to a PC/laptop running iSense software. When calibrating an optical DO sensor with the iLink Multi, calibration parameters are captured automatically using the built-in, physical parameter sensors.



### Did You Know

iSense Mobile allows you to check sensor status or conduct calibrations from the convenience of your phone. Download is free at Google Play or iTunes.

► [www.mt.com/ism-accessories](http://www.mt.com/ism-accessories)

Learn more about iSense, iSense Mobile and its accessories.

## Verification Kits

### Simulating Sensors and Validating Transmitters



The pH, O<sub>2</sub> and the CO<sub>2</sub> Verification Kits are sets of five different service tools that allow the simulation of reading values of pH, O<sub>2</sub> and the CO<sub>2</sub> ISM sensors with predefined measuring values and errors (not changeable by the user). Each tool corresponds to a METTLER TOLEDO ISM sensor and delivers a complete set of data information. They can also be used for control of loop and transmitter settings, as control of the transmitter's temperature compensation and general troubleshooting. Each verification kit is provided with a certificate.

#### Specifications

##### ISM Verification Kits

ISM Simulator pH Kit	pH 4, pH 7, toggle, ERR1, ERR2
ISM Simulator O <sub>2</sub> (InPro 6850i) Kit	Zero, Air, toggle, ERR1, ERR2
ISM Simulator O <sub>2</sub> ppb (InPro 6900i/InPro 6950i) Kit	Zero, Air, toggle, ERR1, ERR2
ISM Simulator CO <sub>2</sub> (InPro 5000i) Kit	15 mbar, 950mbar, toggle, ERR1, ERR2
Optical O <sub>2</sub> (InPro 6860i, InPro 6870i, InPro 6960i, InPro 6970i, THO ODO) Simulator	Zero, Air 1, Air 2, toggle, ERR1, ERR2

##### pH Analog Verification Kits

pH Simulator 112	pH 4, pH 7, pH 9
VP Simulator	20 °C (Pt100 or Pt1000), 50 °C (Pt100 or Pt1000)

##### Certificates and Approvals

ISM pH	IECEX/ATEX Ex ia IIC T6/T5/T4/T3 Ga/Gb FM: IS/I, II, III/1/ABCDEFG/T6
Amperometric O <sub>2</sub>	IECEX/ATEX Ex ia IIC T6/T5/T4/T3 Ga/Gb IECEX/ATEX Ex ia IIIC T69 °C/T81 °C/T109 °C/ T161 °C Da/Db FM: IS/I, II, III/1/ABCDEFG/T6

##### Features Overview

- Tool for verification of a measuring system
- Service tool for quick checks
- Control of transmitter settings
- Troubleshooting

**Ordering Information**

ISM Verification Kits	Order Number
ISM Simulator pH Kit	52 300 410
ISM Simulator O <sub>2</sub> (InPro 6850 i) Kit	52 300 416
ISM Simulator O <sub>2</sub> ppb (InPro 6900 i) Kit	52 300 422
ISM Simulator O <sub>2</sub> Trace (InPro 6950 i) Kit	52 300 428
ISM Simulator CO <sub>2</sub> (InPro 5000 i) Kit	30 031 035
Optical O <sub>2</sub> (InPro 6860 i, InPro 6870 i, InPro 6960 i, InPro 6970 i, THO ODO) Simulator	30 404 694

pH Analog Verification Kits	Order Number
pH Simulator 112	59 906 431
VP Simulator	52 120 939



**Did You Know**

The ISM pH, oxygen and CO<sub>2</sub> service tools are unique products that can control and verify loop and transmitter settings. The simulators generate a comprehensive data-set of non-modifiable ISM parameters.



Optical O<sub>2</sub> Simulator



pH Analog Verification Kits: Combining the pH simulator 112 ① with the VP simulator ② both pH and Temperature signals can be simulated to check the automatic temperature compensation capability of the transmitter.

## Process Connection Hardware Solutions for Every Challenge

METTLER TOLEDO Ingold offers a comprehensive line of products to connect to all common process environments – open basins, pipes, closed tanks, chemical reactors, bioreactors, and fermentation vessels. Depending upon the application, each connection type can have specific requirements for strength, safety, cleanliness, optimized performance, corrosion resistance, insertion depth, or physical space. Process connection hardware ranges from simple drop-in immersion fittings to complex automated systems capable of cleaning and calibrating your measuring equipment. The choice is yours! METTLER TOLEDO Ingold and your local representatives have worked extensively with a wide variety of process environments and can assist you in selecting the best hardware for your application.

The primary considerations when selecting a housing are:

1. Stationary or retractable housing
2. Connection entry: top-entry, side-entry, etc. (see illustration)
3. Connection style: cap nut, threaded NPT, etc.
4. Diameter of connection hole (bore size)
5. Insertion length
6. Wetted part materials: stainless steel, PVC, etc.
7. Process seal material (O-rings/gaskets)

This section has been organized according to the seven requirements listed above. To simplify selection, first decide if you prefer stationary,

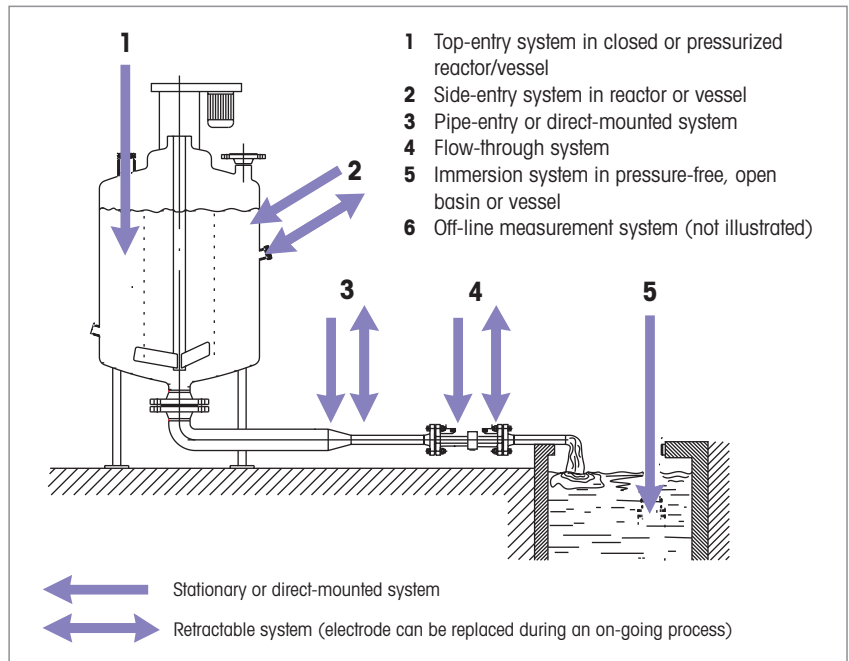

Common Entry/Style	Threaded Cap Nut	Threaded NPT	ANSI/DIN Flange	Ladish (Tri-Clamp)	Tuchenhagen/Varivent
1 Top-Entry	•	•	•	•	–
2 Side-Entry	•	•	•	•	•
3 Pipe-Entry	•	•	•	–	–
4 Flow-Through	•	•	•	–	–
5 Immersion	–	–	–	–	–

Common Wetted Parts	Key	Common O-rings	Key
Stainless Steel 316L	SS 316L	EPDM FDA Listed	EP
Stainless Steel 316L with Electropolish	SS E-P	EPDM Peroxide Cured	EP-pc
Stainless Steel 316L with Machined Surface	R <sub>a</sub> XX	Kalrez® FDA Listed USP Class VI	Ka-FDA-USP VI
Hastelloy	HA-C22	Silicone FDA Listed USP Class VI	Si-FDA-USP VI
Titanium	Ti	Silicone Peroxide Cured	Si-pc
PVC	PVC	PTFE/PTFE Coated*	N/A
PVDF	PVDF	Viton® FDA Listed	Vi
PTFE	PTFE	* As tested PTFE materials failed to provide acceptable elastomeric sealing and are not recommended.	

retractable, or flow through design and turn to the corresponding section that follows. A variety of different housings are available in each section

to meet your specific entry-type, connection style, and other requirements.

### The Ingold Socket and Safety Socket

Recognizing the need for a strong, sanitary, and safe process connection, Ingold engineered a socket to exceed the requirements found in the most demanding process environments.



When used with an appropriate housing, the Ingold Safety Socket allows the housing O-ring to break its seal while the cap nut retains a safe thread engagement. (See diagram below).

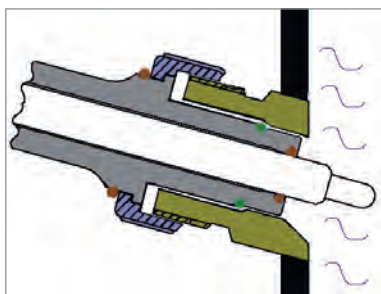

#### Retractable housings:

- **Secure**
- **Self-cleaning**
- **Process-independent**
- **Manual or automated**
- **Insertion lock without sensor**
- **For use in hazardous areas (ATEX, FM certificates)**

### Ingold housings

The hardware used to connect your analytical system to your process is now more important than ever and can actually improve your overall operating efficiency.

Retractable housings, first pioneered by METTLER TOLEDO Ingold, have now evolved into highly-sophisticated components which are process-independent, making sensor maintenance possible at any time without interrupting your process. Pneumatically operated housings insert and retract sensors automatically and form the cornerstone of a fully autonomous analytical system, capable of unattended cleaning and calibration. With an automated system your highly-skilled maintenance staff is able to focus on critical maintenance and repair projects rather than cleaning and calibrating sensors, raising the efficiency and productivity of your operation. For more information on automated maintenance systems, see page 126.

Stationary housings are widely used in all industries, providing a secure, durable, and safe way to position sensing devices in a process. Once connected, however, the stationary housing and sensor must be left in place until the process stops or flow is interrupted and the tank/pipe is drained.



### Wide range of process connections

Only a representative sample of Ingold's extensive process connection products are included in this catalog. Please refer to the METTLER TOLEDO product literature for more information.



### Don't see exactly what you need?

METTLER TOLEDO Ingold has more than 50 years of experience engineering specialized components or altering existing products to meet specific project requirements. Whether your need is for process resistant metals, special finishes, or modified dimensions, challenge us – chances are we have already designed what you need.



### Looking for a non-standard connection?

A growing number of projects co-locate redundant production facilities around the globe, occasionally standardizing process connections. METTLER TOLEDO Ingold is an international company, working with clients world-wide to equip state-of-the-art processing facilities with liquid analytical systems. If your project requires special process connections, we can help.

## Sockets, Flanges, and Plugs

### Reliable Adaption to the Process

#### Weld-in Sockets and Flanges



#### Ingold Socket and Safety Socket (DN25 and DN25/S)

The new safety weld-in sockets provide increased protection in the event of any premature attempt to remove the housing when the reactor or pipe is still under pressure or filled with medium. The socket is designed to prevent possible injury, damage or loss of medium. The Ingold Safety Socket is EHEDG approved.

#### Safety Feature:

- InFit 761-NC
- InFit 764-50-NC
- InPro 68xx

#### No Safety Feature:

- All previous types of housings or 25 mm DO sensors can be used, but without the benefit of the safety feature.

#### Specifications

Wetted Parts	Finish	Pressure Rating
Stainless 316L	N6/R <sub>a</sub> 32 (R <sub>a</sub> =0.8 μm/32 μin)	16 bar (232 psi)

#### Screw-in Sockets



Primarily used for 19 mm vessel and pipe mounting applications.

#### Specifications

Wetted Parts	Finish
Stainless 316L	N6/R <sub>a</sub> 32 (R <sub>a</sub> =0.8 μm/32 μin)

#### Blind Plugs



Manufactured to exacting standards to seal unused weld-in sockets and ports during cleaning and general operation.

#### Specifications

Wetted Parts	Finish
Stainless 316L	N6/R <sub>a</sub> 32 (R <sub>a</sub> =0.8 μm/32 μin)

## Ordering Information

<b>Ingold Sockets</b>	<b>Bore Size</b>	<b>Insertion Length</b>	<b>Angle</b>	<b>Order Number</b>
Ingold socket, weld-in	25 mm	40 mm	15°	59 901 124
Ingold socket, weld-in	25 mm	40 mm	0°	59 901 127
Ingold socket, weld-in	25 mm	48 mm	15°	59 901 125
Ingold socket, weld-in	25 mm	50 mm	0°	59 901 128
Ingold socket, weld-in	25 mm	55 mm	15°	59 901 126
Ingold socket, weld-in	25 mm	60 mm	0°	59 901 129
OPTIONS: R <sub>a</sub> finish, electro-polish, non-reactive materials, other				Contact METTLER TOLEDO

<b>Ingold Safety Sockets</b>	<b>Bore Size</b>	<b>Insertion Length</b>	<b>Angle</b>	<b>Order Number</b>
Ingold safety socket, DN25/S weld-in	25 mm	40 mm	15°	52 400 462
Ingold safety socket, DN25/S weld-in	25 mm	47 mm	0°	52 400 518
OPTIONS: R <sub>a</sub> finish, electro-polish, non-reactive materials, other				Contact METTLER TOLEDO

<b>Screw-in Sockets</b>	<b>Bore Size</b>	<b>Insertion Length</b>	<b>Angle</b>	<b>Order Number</b>
Screw-in socket	19 mm	40 mm	0°	59 901 290

<b>Blind Plugs</b>	<b>Connect</b>	<b>Bore Size</b>	<b>Insertion Length</b>	<b>Wetted Parts</b>	<b>Order Number</b>
BSP socket plug, straight	2¾" BSP	25 mm	50 mm	Stainless 316L	59 900 903
Ingold socket plug, straight DN25	Ingold	19 mm	42 mm	Stainless 316L	59 901 294
Ingold socket plug, straight DN25	Ingold	25 mm	40 mm	Stainless 316L	59 901 287
Ingold socket plug, 15° DN25	Ingold	25 mm	40 mm	Stainless 316L	59 901 283
Ingold socket plug, 15° DN25	Ingold	25 mm	48 mm	Stainless 316L	59 901 284
Ingold socket plug, straight DN25	Ingold	25 mm	50 mm	Stainless 316L	59 901 288
Ingold socket plug, 15° DN25	Ingold	25 mm	55 mm	Stainless 316L	59 901 285
Ingold socket plug, straight DN25	Ingold	25 mm	60 mm	Stainless 316L	59 901 289
OPTIONS: R <sub>a</sub> finish, electro-polish, non-reactive materials, O-rings, process connection, other					Contact METTLER TOLEDO

## InFit 761 e

### High Versatility with a Wide Selection of Process Connections



The InFit 761 e series housings are stationary housings for 12 mm sensors with a Pg 13.5 threaded collar. This is one of the most versatile housings in the Ingold product line due to the wide availability of materials, O-rings, process connections, and insertion lengths. Rugged plastic (PVDF, PP), stainless steel, and Hastelloy (optional) versions stand up to harsh and demanding environments encountered in industrial processing and industrial wastewater applications. For extreme hygienic requirements, the InFit 761 e is available in 316L stainless steel configurations (EHEDG and 3A compliant), and also with N5/R<sub>a</sub> 16 surface finishes to meet the most stringent regulatory guidelines.

#### Specifications

	InFit 761 e, Steel Version	InFit 761 e, Plastic Version
Wetted parts	Stainless 316L	PVDF, PP
Surface finish (O-ring groove/Other)	N5/N5 (R <sub>a</sub> 16/R <sub>a</sub> 16)*	N6/N7 (R <sub>a</sub> 32/R <sub>a</sub> 63)
O-ring***	Silicone-FDA-USP VI	Viton®-FDA
Sensor fitting	Pg 13.5	Pg 13.5
Temperature range	0–140°C/32–284°F	0–100°C/32–212°F
Pressure rating (Sensor dependent)	Max. 16 bar/232 psig	Max. 6 bar/87 psig**
<b>Certificates and Approvals</b>	EHEDG and 3A compliant (CIP shaft only) ATEX/FM certificates (metallic version only): Pressure Equipment Directive guidelines (PED) and CE	

\* Not with protective cage

\*\* Temperature dependent

\*\*\* Other O-ring material see technical document

Many housing options are available. Please use the product configurator and sensor fit guide found on p. 115.

#### Suggested Sensors

pH	DO	CO <sub>2</sub>	Conductivity	Turbidity
InPro 3030	InPro 6050	InPro 5000 (i)	InPro 7001	InPro 8050
InPro 3100 (i)	InPro 6800 (G)		InPro 7100 (i)	InPro 8100
InPro 3250 (i)	InPro 6850 i (G)			InPro 8200
InPro 4010	InPro 6900 (i) (G)			
InPro 4260 (i)/4281 i	InPro 6950 (i) (G)			
InPro 4800 (i)/4881 i	InPro 6860 i* /6970 i*			
DPAS, DPA				
DXK				

\* special Retrofit Kit required

#### Other Highlights

- Simple, yet highly durable
- Easy-to-use and low maintenance

#### Features Overview

- Models with sensor holder type "C" integrate with the Ingold safety socket to prevent injury or damage

- Many options for corrosion-resistant materials, O-rings, and process connections
- Surface finish N5/R<sub>a</sub> 16 (excluding version with protective cage)

► [www.mt.com/InFit761](http://www.mt.com/InFit761)





# InFit 764 e

## Problem Solver in Combination with Liquid-filled pH Electrodes



The InFit 764 e housings are specifically designed to maximize the performance and longevity of liquid-filled pH and redox sensors. The body of the housing can be pressurized to maintain a positive pressure differential between the sensor fill solution and the process. The positive differential eliminates sensor contamination by preventing process media from crossing the diaphragm into the sensor. A large inspection window makes it easy to monitor electrolyte level.

### Specifications

	InFit 764 e, Steel Version	InFit 764 e, Plastic Version
Wetted parts	Stainless 316L	PVDF
Surface finish (O-ring groove/Other)	N5/N5 (R <sub>a</sub> 16/R <sub>a</sub> 16) *	N6/N6 (R <sub>a</sub> 32/R <sub>a</sub> 32)
O-ring ***	Silicone-FDA-USP VI	Silicone-FDA-USP VI
Sensor fitting	Liquid-filled electrodes	Liquid-filled electrodes
Temperature range	0–130 °C/32–266 °F	0–110 °C/32–230 °F
Pressure rating (Sensor dependent)	0–6 bar/0–87 psig	0–6 bar/0–87 psig **

**Certificates** ATEX/FM certificates (metallic version only):

**and Approvals** Pressure Equipment Directive guidelines (PED) and CE

\* Not with protective cage

\*\* Temperature dependent

\*\*\* For other O-ring material see technical documentation

Many housing options are available. Please use the product configurator found on p. 115.

### Suggested Sensors

pH	DO	CO <sub>2</sub>	Conductivity	Turbidity
InPro 2000 (i)	N/A	N/A	N/A	N/A

### Sensor Fit Guide (for Liquid-Filled Electrodes)

Sensor Length	Insertion Length			
	70mm	100mm	150mm	200mm
120mm	•	–	–	–
150mm	–	•	–	–
200mm	–	–	•	–
250mm	–	–	–	•

The InFit 764 e housing is specifically designed for use with liquid-filled pH sensors. This sensor fit guide is designed to assist you with selecting the proper pH sensor. Other insertion lengths are available on request.



USP  
Class VI



### Other Highlights

- 3A compliant (CIP shaft only)

### Features Overview

- Positive overpressure
- Large inspection window
- Sterilizable in situ
- Surface finish N5/R<sub>a</sub> 16 (excluding version with protective cage)

## InFit 762 e/763 e

### The Solution for Top-Entry into Large Vessels



InFit 762 e

InFit 763 e



#### Other Highlight

- Certificates of compliance are available upon request, including certificate of inspection 3.1

► [www.mt.com/InFit762](http://www.mt.com/InFit762)

► [www.mt.com/InFit763](http://www.mt.com/InFit763)

The InFit 762 e and InFit 763 e stationary housings are designed for top mount applications in larger vessels and reactors. An optional protective cage may be ordered separately. The static insertion housing InFit 762 e allows quick and easy installation of electrodes and sensors with Pg 13.5 thread. This allows the use of a large range of pH/redox electrodes with solid or gel-type reference electrolyte as well as sensors for measuring conductivity, turbidity, dissolved oxygen and CO<sub>2</sub>. The static insertion housing InFit 763 e provides quick and easy integration of pressurized pH/redox electrodes with liquid and refillable reference electrolyte. The InFit 763 e (PVDF version) housing is specifically designed for applications where tank damage is of concern – especially glass-lined reactors. The InFit 763 e (PVDF version) housing connects to the process using a variety of available flanges; however, a PN16 (AISI 150) flange is specified most often. A protective cage protects the electrode against abrasive solids in the process medium. The InFit 763 e (PVDF version) is designed for use where stainless steel is unsuitable and/or if the reactor is lined with rubber or glass.

#### Specifications

	InFit 762 e/763 e, Steel Version	InFit 763 e, Plastic Version
Wetted parts	Stainless 316 L/C22/Ti	PVDF
Surface finish (O-ring groove/Other)	N6/N8 (R <sub>a</sub> 32/R <sub>a</sub> 125)	N6/N8 (R <sub>a</sub> 32/R <sub>a</sub> 125)
O-ring**	Viton®-FDA	Viton®-FDA
Sensor fitting	762 e: Pg 13.5 763 e: InPro 2000	InPro 2000/Pg 13.5 (opt.)
Temperature range	0 – 130 °C/32 – 266 °F	0 – 130 °C/32 – 266 °F
Pressure rating (Sensor dependent)	0 – 6 bar/0 – 87 psig	0 – 10 bar/0 – 145 psig*

**Certificates and Approvals** ATEX/FM certificates (metallic version only):  
Pressure Equipment Directive guidelines (PED) and CE

\* Temperature dependent \*\* Other O-ring material see technical documentation

#### Suggested Sensors

	pH	DO	CO <sub>2</sub>	Conductivity	Turbidity
<b>InFit 762 e</b>	InPro 3030 InPro 3100 (i) InPro 3250 (i) InPro 4260 (i) InPro 4800 (i) DPAS, DPA DXK	InPro 6050 InPro 6800 (G) InPro 6850 (i) (G) InPro 6900 (i) (G) InPro 6950 (i) (G)	N/A	InPro 7001 InPro 7100 (i)	InPro 8050 InPro 8100 InPro 8200
<b>InFit 763 e</b>	InPro 2000 (i)	N/A	N/A	N/A	N/A

Many housing options are available. Please use the product configurator and sensor fit guide found on p. 116

#### Features Overview

- Up to 4 m (13.1 ft) insertion length
- Extra long insertion lengths
- Rugged stainless steel or PVDF construction
- Uses cost-effective 120 mm/150 mm sensors

# InDip 500 Series

## Immersion Housing for Open Basin Installations



The InDip™ immersion housings are designed to provide a cost-effective, yet rugged process connection with the flexibility to meet the wide variety of installation requirements found in open tanks, reactors, aeration basins and open vessels.

### Specifications

InDip 550	
Wetted parts	PVC, PVDF
Surface finish (O-ring groove/Other)	N/A
O-ring	Viton®-FDA
Sensor fitting	Pg 13.5, 1" NPT, ¾" NPT, IND
Temperature range	0–60 °C/32–140 °F (PVC) 0–100 °C/32–212 °F (PVDF)
Pressure rating (Sensor dependent)	N/A

### Suggested Sensors

pH	DO	CO <sub>2</sub>	Conductivity	Turbidity
InPro 3030	InPro 6050	N/A	InPro 7001	InPro 8050
InPro 3100 (i)	InPro 6800 (G)		InPro 7108	InPro 8100
InPro 3250 (i)	InPro 6850 (i) (G)		InPro 7250	
InPro 4010	InPro 6900 (i) (G)		InPro 7100 (i)	
InPro 4260 (i)	InPro 6950 (i) (G)			
InPro 4501				
InPro 4800 (i)				
DPA				
DPAS				
DXK				

### Sensor Fit Guide

Sensor Length	Insertion Length
120 mm	User-defined (max. 3 m)

The InDip 550 is designed to accept all 120 mm sensors.

Many housing options are available. Please use the product configurator found on p. 117

### Features Overview

- Watertight
- Choice of materials
- Wide range of installation options
- Automation with EasyClean 100

## InFlow Series Modular, Highly Adaptable Flow-Through Housings



InFlow 761



InFlow 762



InFlow 751

InFlow 76X flow-through housings from METTLER TOLEDO are designed to enable safe and reliable mounting of the InTrac and InFit series sensor housings directly into the process or in a bypass (pipe). These rugged flow-through housings are specially suited to the requirements of the process industry and can be easily and safely installed, allowing reliable measurement procedures.

InFlow 751 flow-through housings serve for the direct fitting of METTLER TOLEDO electrodes and sensors for the measurement of pH, ORP, dissolved oxygen, conductivity and turbidity, particularly in the field of industrial wastewater treatment. The housings protect electrodes/sensors against mechanical damage.

### Specifications

	InFlow 751, PVC Version	InFlow 751, PVDF Version
Wetted parts	PVC	PVDF
Surface finish	N/A	N/A
(O-ring groove/Other)		
O-ring	Viton®-FDA	Viton®-FDA
Sensor/housing fitting	Pg 13.5, 1" NPT, ¾" NPT	Pg 13.5, 1" NPT, ¾" NPT
Temperature range	0–60 °C/32–140 °F	0–100 °C/32–212 °F
Pressure rating	1 bar/60 °C (14.5 psi/140 °F)	1 bar/100 °C (14.5 psi/212 °F)
(Sensor dependent)	4 bar/45 °C (58 psi/113 °F)	4 bar/75 °C (58 psi/167 °F)

	InFlow 761	InFlow 762
Wetted parts	Stainless 316L	PVDF
Surface finish	N/A	N/A
(O-ring groove/Other)		
O-ring	N/A	Viton®-FDA*
Sensor/housing fitting	InTrac 7XX, InFit 76X	InTrac 7XX, InFit 76X
Temperature range	0–140 °C/32–284 °F	0–140 °C/32–284 °F
Pressure rating	16 bar/140 °C (232 psi/284 °F)	1 bar/140 °C (14.5 psi/284 °F)
(Sensor dependent)		6 bar/80 °C (87 psi/176 °F)

**Certificates and Approvals** CE, Pressure Equipment Directive guidelines (PED)

\* Version with Ingold DN25 socket

### Features Overview

- Correctly positions sensors in tight confines of narrow pipes and slip streams
- Wide variety of materials and process connections to accommodate common process environments
- Optimally designed for use with METTLER TOLEDO housings and sensors

### Suggested Sensors

pH	DO	CO <sub>2</sub>	Conductivity	Turbidity
465	InPro 6050	InPro 5000 (i)	InPro 7001	InPro 8050
InPro 2000 (i)	InPro 6800 (G)		InPro 7100 (i)	InPro 8100
InPro 3250 (i)	InPro 6850 (i) (G)			
InPro 4010	InPro 6900 (i) (G)			
InPro 4260 (i)	InPro 6950 (i) (G)			
InPro 4501				
InPro 4800				
DPA				
DXK				

### Sensor Fit Guide

Sensor Length	InFlow 751	InFlow 76X
120mm	•	•

1 See appropriate housing section

Many housing options are available. Please use the product configurator found on p. 117.

► [www.mt.com/InFlow](http://www.mt.com/InFlow)





## Ordering Information for InFlow 751

### InFlow 751

– PVC Version	Process Connect	Bore Size	Insert Length	Wetted Parts	Order Number
InFlow 751 d32DN25	Pg 13.5	32 mm	N/A	PVC	52 400 250
InFlow 751 d32DN25	NPT 3/4"	32 mm	N/A	PVC	52 400 256
InFlow 751 d50DN40	Pg 13.5	50 mm	N/A	PVC	52 400 251
InFlow 751 d50DN40	NPT 3/4"	50 mm	N/A	PVC	52 400 257
InFlow 751 d50DN40	NPT 1"	50 mm	N/A	PVC	52 400 644
InFlow 751 d63DN50	Pg 13.5	63 mm	N/A	PVC	52 400 252
InFlow 751 d63DN50	NPT 3/4"	63 mm	N/A	PVC	52 400 258
InFlow 751 d63DN50	NPT 1"	63 mm	N/A	PVC	52 400 645
– PVDF Version					
InFlow 751 d32DN25	Pg 13.5	32 mm	N/A	PVDF	52 400 253
InFlow 751 d32DN25	NPT 3/4"	32 mm	N/A	PVDF	52 400 259
InFlow 751 d50DN40	Pg 13.5	50 mm	N/A	PVDF	52 400 254
InFlow 751 d50DN40	NPT 3/4"	50 mm	N/A	PVDF	52 400 260
InFlow 751 d50DN40	NPT 1"	50 mm	N/A	PVDF	52 400 646
InFlow 751 d63DN50	Pg 13.5	63 mm	N/A	PVDF	52 400 255
InFlow 751 d63DN50	NPT 3/4"	63 mm	N/A	PVDF	52 400 261
InFlow 751 d63DN50	NPT 1"	63 mm	N/A	PVDF	52 400 647

For the housing configuration of the InFlow 76X, please use the product configurator below.

## Product configurator for InFlow 76X – not all configurations are possible

Material (others on request)															1.4404/316L PVDF (polyvinylidene fluoride)															
1	/	4	4	0	4	1	8	0	Flow-through direction											180°	90°									
2	/	P	V	D	F	-	9	0																						
															Process connection*															
															D	2	5	DIN flange DN25 PN16												
															D	5	0	DIN flange DN50 PN16												
															A	0	1	ANSI flange A150-1"												
															A	0	2	ANSI flange A150-2"												
															W	2	5	Welding connection DN25 (1")												
															W	5	0	Welding connection DN50 (2")												
															Housing connection*															
															D	0	0	Ingold DN25												
															D	0	4	DIN flange DN50												
																		Special										-	Standard	
																												S	Special	
InFlow 76		/																												
	9		10		11		12		13		14		15		16		17		18		19		20		21		22		23	



### Seals

The InFlow 76X PVDF version with Ingold DN25 socket is fitted with a medium-wetted O-ring made of Viton®. O-ring sets made of EPDM and Kalrez® are available as accessories.

## Product configurator for InDip 550 – not all configurations are possible

Insertion length (others lengths on request)				
1000 mm insertion length				
1500 mm insertion length				
2000 mm insertion length				
2500 mm insertion length				
3000 mm insertion length				
Material (wetted parts)				
PVC (Polyvinyl chloride)				
PVDF (Polyvinylidene fluoride)				
Sensor interface				
Pg 13.5 (with protective cage P or GP available)				
3/4" NPT				
Cond 1" NPT				
IND (for InPro 7250)				
Protective cage				
P				
GP				
InDip 550	1000	PVC	Cond 1" NPT	-
	1500	PVDF	Pg 13.5	-
	2000	PVC	Pg 13.5	GP



### Important addition to the order information for InDip 550 housings

Flanges for the InDip 550 have to be ordered separately. They cannot be included to the part number of the housing. Local assembly of InDip housings is also possible. Ask your local METTLER TOLEDO representative.



### Did You Know

Measurement loops from METTLER TOLEDO can be automated with the EasyClean systems for rinsing, cleaning and calibrating. See pages 126–131 for more information.

## InTrac 776e For Liquid-Filled pH Electrodes



**USP  
Class VI**



The retractable InTrac 776e housings are designed for applications in processes which utilize pH/ORP sensors that have a liquid electrolyte reference system such as the InPro 2000 and Ingold 465 series electrodes. The housing has a built-in flushing chamber in which the electrode can be cleaned and calibrated if necessary, both accomplished without interruption of the process. This enhanced housing incorporates the Tri-Lock™ safety system which increases process safety and reliability even in harsh applications.

### Specifications

Operation	Manual or pneumatic	
Ambient temperature	Polypropylene:	0 to 70 °C (32 to 158 °F)
	Stainless steel:	- 10 to 70 °C (14 to 158 °F)
Functional pressure range	Manual:	0 to 5 bar (0 to 73 psig)
	Pneumatic:	0 to 6 bar (0 to 87 psig)
Max. permissible pressure	Polypropylene (PP):	6 bar at 20 °C (87 psig at 68 °F)
	PVDF, PEEK:	6 bar at 20 °C (87 psig at 68 °F)
	316 L stainless steel:	6 bar at 140 °C (87 psig at 276 °F)
	Hastelloy /Ti:	6 bar at 140 °C (87 psig at 276 °F)
Insertion lengths	70 mm, 100 mm, 200 mm (2.76", 3.94", 7.87")	
Wetted parts	316 L stainless steel, Hastelloy –C22, titanium, PP, PVDF, PEEK	
Wetted O-rings	Viton®-FDA, EPDM-FDA, Kalrez®-FDA-USP Class VI	
Housing length	70/100 mm:	545 mm (21.8") in process
		710 mm (28") retracted from process
	200 mm:	645 mm (25.4") in process
		1110 mm (43.7") retracted from process
Pneumatic conditions	4 to 8 bar (58 to 116 psig)	
Flushing connections (water, steam)	2 to 6 bar (29 to 87 psig)	
Position monitoring (options)	Pneumatic check (3/2 way valve), G1/8"	
	Inductive check, non-Ex, M12 × 1	
	Inductive check, Ex, M12 × 1	

### Certificates and Approvals

CE;  
Pressure Equipment Directive guidelines (PED);  
Certificate of conformity according to EN10204-2.1;  
Material certificate according to 3.1;  
ATEX, FM and MaxCert

### Sensor Fit Guide (for Liquid-Filled Glass pH Electrodes)

Sensor Length	Insertion Length		
	70 mm	100 mm	200 mm
250 mm	•	•	–
450 mm	–	–	•

Many housing options are available. Please use the product configurator found on p. 123.



### Did You Know

Measurement loops from METTLER TOLEDO can be automated with the EasyClean systems for rinsing, cleaning and calibrating. See pages 126–131 for more information.

[www.mt.com/InTrac776](http://www.mt.com/InTrac776)



# InTrac 777 e/779 e

## The Reliable All-Rounder



**USP**  
Class VI

**FDA**

**CE**

**Ex**

**FM**  
APPROVED

The retractable InTrac 777 e/779 e housings are specifically designed for applications in processes which utilize 12 mm pH, ORP, dissolved oxygen, CO<sub>2</sub>, conductivity, and turbidity (InTrac 779e) sensors. The housing has a flushing chamber in which the electrode can be cleaned and calibrated if necessary, both accomplished without interruption of the process. This enhanced housing incorporates the Tri-Lock safety system which increases process safety and reliability even in harsh applications. Multiple process connections and materials of construction make the InTrac 777 e/779 e an excellent choice for use in either the chemical, biopharmaceutical or food and beverage industries.

### Specifications

Operation	Manual or pneumatic (295 mm version pneumatic only)
Ambient temperature	Polypropylene: 0 to 70 °C (32 to 158 °F) Stainless steel: -10 to 70 °C (14 to 158 °F)
Functional pressure range	Manual: 0 to 5 bar (0 to 73 psig) Pneumatic: 0 to 16 bar (0 to 232 psig)
Max. permissible pressure	Polypropylene (PP): 6 bar/20 °C (87 psig/68 °F) PVDF, PEEK: 6 bar/20 °C (87 psig/68 °F) 316 L stainless steel: 16 bar/140 °C (232 psig/276 °F) Hastelloy/Ti: 16 bar/140 °C (232 psig/276 °F)
Insertion lengths	70 mm, 100 mm, 200 mm, 295 mm (2.76", 3.94", 7.87", 11.61")
Wetted parts	316 L stainless steel, Hastelloy-C22*, titanium, PP*, PVDF*, PEEK*, * not available for 295 mm version
Wetted O-rings	Viton®-FDA, EPDM-FDA, Kalrez®-FDA and USP Class VI
Housing length	70/100 mm: 360 mm (14.2") in process 515 mm (20.3") retracted from process 200 mm: 460 mm (18.1") in process 915 mm (36") retracted from process
Pneumatic conditions	4 to 8 bar (58 to 116 psig)
Flushing connections (water, steam)	2 to 6 bar (29 to 87 psig)
Position monitoring (options)	Pneumatic check (3/2 way valve), G 1/8" Inductive check, non-Ex, M12 × 1 Inductive check, Ex, M12 × 1
<b>Certificates and Approvals</b>	CE; Pressure Equipment Directive guidelines (PED); Certificate of conformity according to EN10204-2.1; Material certificate according to 3.1; ATEX, FM and MaxCert

Many housing options are available. Please use the product configurator and sensor fit guide found on p. 123.



### Did You Know

Measurement loops from METTLER TOLEDO can be automated with the EasyClean systems for rinsing, cleaning and calibrating. See pages 126–131 for more information.

### Features Overview

- Advanced Tri-Lock safety system
- Remove sensor without interrupting of the process
- Automation with EasyClean

### Other Highlights

- Multiple process connections available
- For use with 12 mm Ingold sensors
- MaxCert covers necessary certifications
- Increased operational safety and reliability
- Several materials of construction available

▶ [www.mt.com/InTrac777](http://www.mt.com/InTrac777)

▶ [www.mt.com/InTrac779](http://www.mt.com/InTrac779)

## InTrac 797 e/799 e When Sterile Conditions Are Required



**USP  
Class VI**

**FDA**

**CE**

**Ex**

**FM  
APPROVED**

### Features Overview

- Twin-chamber lock effectively prevents any external contamination
- Advanced Tri-Lock safety system
- Remove sensor without interrupting of the process

### Other Highlights

- Multiple process connections available
- For use with 12 mm Ingold sensors
- Double flushing chamber
- Increased operational safety and reliability

The retractable InTrac 797 e/799 e housings are specifically designed for applications in processes which utilize 12 mm pH, ORP, dissolved oxygen, CO<sub>2</sub>, conductivity, and turbidity (InTrac 799 e) sensors. This sterilizable housing has a double flushing chamber which was designed to meet the highest demands of the pharmaceutical and food and beverage industries where sterile conditions are required. The double flushing chamber allows complete sterilization of the upper and lower sections of a sensor and insertion shaft allowing the electrode/ sensor to be removed and replaced under a completely sterile environment.

### Specifications

Operation	Manual or pneumatic	
Ambient temperature	Stainless steel: – 10 to 70 °C (14 to 158 °F)	
Functional pressure range	Manual:	0 to 5 bar (0 to 73 psig)
	Pneumatic:	0 to 16 bar (0 to 232 psig)
Max. permissible pressure	316 L stainless steel: 16 bar/130 °C (232 psig at 266 °F)	
Insertion lengths	100 mm (3.94")	
Wetted parts	316 L stainless steel	
Wetted O-rings	Viton®-FDA, EPDM-FDA, Kalrez®-FDA-USP Class VI	
Housing length	100 mm:	460 mm (18.1") in process 715 mm (28.2") retracted from process
Pneumatic conditions	4 to 8 bar (58 to 116 psig)	
Flushing connections (water, steam)	2 to 6 bar (29 to 87 psig)	
Position monitoring (options)	Pneumatic check (¾ way valve), G1/8"	
	Inductive check, non-Ex, M12 × 1	
	Inductive check, Ex, M12 × 1	

### Certificates and Approvals

CE;  
Pressure Equipment Directive guidelines (PED);  
Certificate of conformity according to EN10204-2.1;  
Material certificate according to 3.1;  
ATEX, FM and MaxCert

### InTrac 797 e/InTrac 799 e Sensor Fit Guide

Sensor Length	Insertion Length	
297 mm	100 mm	∅ 12 mm Sensor /electrode
320 mm	•1	Turbidity
325 mm	•2	O <sub>2</sub> , CO <sub>2</sub>
	•2	pH/ORP

1 InTrac 799 e only

2 InTrac 797 e only

Many housing options are available. Please use the product configurator found on p. 124.

▶ [www.mt.com/InTrac797](http://www.mt.com/InTrac797)

▶ [www.mt.com/InTrac799](http://www.mt.com/InTrac799)

# InTrac 781/784

## Designed for the Toughest Process Conditions



InTrac 781

InTrac 784

### Other Highlights

- Multiple process connections available
- Large choice of materials for wetted parts
- Variable insertion length
- Compliance with international standards
- Long life and easily exchangeable seals

The InTrac 781/784 retractable housings combine rugged design with great versatility to meet the demands of the harshest process conditions in chemical, petrochemical, pulp and paper, or utilities applications.

The InTrac 781 operates mainly with the 12 mm diameter (Pg 13.5) sensors, while the InTrac 784 operates with the InPro 2000 (i)/465 pH/ORP sensor.

The retractable housing material is specially designed for a range of harsh applications. Wetted parts are available in different materials (1.4404/SS 316L; Alloy C-22, PP; PVDF or PEEK), offering installation flexibility in many applications. The intelligent sensor locking system in the housing enhances operational safety. Without the presence of a sensor, the housing cannot be inserted into the process. Also, it makes it possible to remove the sensor from the housing when in the service position.

### Specifications

Operation	Manual or pneumatic or pneumatic with inductive check back
Ambient temperature	SS 316L, Alloy C-22: -10 to 70 °C (14 ... 158 °F) PP, PVDF, PEEK: 0 to 70 °C (32 ... 158 °F)
Max. permissible pressure and temperature	SS 316L, Alloy C-22: 16 bar/120 °C or 10 bar/140 °C (232 psi/248 °F or 145 psi/284 °F) PP: 4 bar/60 °C or 2 bar/70 °C (58 psi/140 °F or 29 psi/158 °F) PVDF: 6 bar/90 °C or 4 bar/100 °C (87 psi/194 °F or 58 psi/212 °F) PEEK: 10 bar/100 °C or 6 bar/120 °C (145 psi/212 °F or 87 psi/248 °F)
Insertion length	80 mm (3.15") or 280 mm (11.02")
Wetted parts	SS 316L, Alloy C-22, PP, PVDF, PEEK or PVDF
Wetted O-rings	Viton®, Kalrez® or EPDM
Process connections	Flanges: DIN or AISI, or NPT 1 1/4"
Pneumatic condition	4 to 6 bar
Flushing condition (water)	1 to 6 bar
<b>Certificates and Approvals</b>	CE; Pressure Equipment Directive guideline (PED); ATEX and FM

Many housing options are available. Please use the product configurator found on p. 125.

### Features Overview

- Highly efficient cleaning chamber
- Intelligent sensor locking system to prevent unintentional removal of the sensor
- Integrated sensor protective cage to protect the sensor in cases of fast process flow
- Specially designed drive train allows sensor retraction from high process pressures and temperatures
- Automated sensor cleaning with EasyClean

## Retractable Housings

Sensor Access Without Process Interruption



Housings

# InTrac 785/787 For Harsh Applications



InTrac 785

InTrac 787

InTrac 785/787 is a rugged, retractable housing for the most demanding industrial applications. Sensor maintenance and replacement becomes a fast and easy task using the InTrac 785/787, and can be done without any interruption to your process. Once retracted, the integral ball valve completely seals off your process, preventing loss of medium or contamination. The design allows for direct mounting to process lines, tanks and reactor vessels.

The InTrac 785 allows a wide range of installation possibilities, thanks to the wide variety of process connections and materials for wetted parts. If the ball valve is already present or a factory standard needs to be used, this housing is also available without ball valve and process connection.

Specifications	InTrac 785	InTrac 787
Wetted parts	316L, C22, titanium Ball valve always made of 1.4408	Stainless 316L
Surface finish	N6 (Ra 32)	N6/N5 (Ra 32/Ra 16)
O-ring	Viton®, Kalrez®	Viton®-FDA
Sensor fitting	Pg 13.5	Pg 13.5
Temperature range	Up to 140 °C/276 °F	Up to 140 °C/276 °F
Pressure rating	16 bar (232 psi)	9 bar (130 psi)
(Sensor dependent)		
<b>Certificates and Approvals</b>	CE, Pressure Equipment Directive guidelines (PED)	

### Suggested Sensors InTrac 785

pH	DO	CO <sub>2</sub>	Conductivity	Turbidity
All 425 mm	All 420 mm	N/A	InPro 7100/425*	All 409 mm

\* with InTrac 785 without protective cage

### Suggested Sensors InTrac 787 (all 120 mm length)

pH	DO	CO <sub>2</sub>	Conductivity	Turbidity
InPro 3030	InPro 6050	N/A	InPro 7001	InPro 8050
InPro 3100 (i)	InPro 6800 (G)		InPro 7108	InPro 8100
InPro 3250 (i)	InPro 6850 (i) (G)		InPro 7100 (i)	InPro 8200
InPro 4010	InPro 6900 (i) (G)			
InPro 4260 (i)	InPro 6950 (i) (G)			
InPro 4281 i				
InPro 4800 (i)				
InPro 4881 (i)				
DPA				
DPAS				
DXK				

Many housing options are available. Please use the product configurator for InTrac 785 found on p. 124 or ordering information for InTrac 787 found on p. 125.

### Features Overview

- Anti-blowout tip prevents accidental blowout
- Variable insertion length
- Flushing chamber available
- Wide range of installation options
- Flexibility in maintenance intervals due to sensor access during running process
- Smooth and reliable operation even in applications with high fiber concentration

▶ [www.mt.com/InTrac785](http://www.mt.com/InTrac785)  
▶ [www.mt.com/InTrac787](http://www.mt.com/InTrac787)

**Product Configurators**

**InTrac 777 e/InTrac 779 e Sensor Fit Guide**

Sensor Length	Insertion Length			
	70 mm	100 mm	200 mm	295 mm
205 mm (Turbidity)	• <sup>1</sup>	• <sup>1</sup>	–	–
220 mm (O <sub>2</sub> /CO <sub>2</sub> )	•	•	–	–
225 mm (pH/ORP)	•	•	–	–
407 mm (Turbidity)	–	–	• <sup>1</sup>	–
420 mm (O <sub>2</sub> /CO <sub>2</sub> )	–	–	•	•
425 mm (pH/ORP/Conductivity)	–	–	•	•

<sup>1</sup> InTrac 779e only

**Product configurator: InTrac 775 e, InTrac 776 e, InTrac 777 e, and InTrac 779 e – not all configurations are possible**

<b>Flushing chamber</b>				
7	Single flushing chamber			
<b>Electrode/sensor type</b>				
5	pH electrodes with dual-membrane, pNa reference system (only available in PVDF or Titan with 70 or 100mm Insertion length)			
6	pH electrodes with liquid electrolyte (not available with the 295 mm version)			
7	pH electrodes with gel/polymer electrolyte and sensors with Pg 13.5 thread			
9	Turbidity sensors (not available with the 295 mm version)			
<b>Operation mode</b>				
M	Manual operation (not available with the 295 mm version)			
P	Pneumatic operation			
R	Pneumatic operation with pneumatic position indication			
I	Pneumatic operation with inductive position indication, non-Ex			
X	Pneumatic operation with inductive position indication, Ex			
<b>Insertion length (H)</b>				
0	7	0	H=70 mm	
1	0	0	H=100 mm	
2	0	0	H=200 mm	
2	9	5	H=295 mm	
<b>Material (wetted parts)</b>				
4	4	0	4	DIN 1.4404/AISI 316 L (stainless steel)
C	2	2	–	DIN 2.4602/Alloy C22 (on request for 295 mm version)
T	i	–	–	Titanium (on request for 295 mm version)
P	P	–	–	Polypropylene (not available with the 295 mm version)
P	V	D	F	Polyvinylidene fluoride (not available with the 295 mm version)
P	E	E	K	Polyetherether ketone (not available with the 295 mm version)
<b>Process connection</b>				
D	0	0	0	Ingold DN25 weld-in socket
D	0	2	–	Flange DN32 PN16 (SS version only)
D	0	3	–	Flange DN40 PN16
D	0	4	–	Flange DN50-PN16
A	0	2	–	ANSI Flange A150-1 1/2"
A	0	3	–	ANSI Flange A150-2"
A	0	4	–	ANSI Flange A150-3"
N	0	1	–	NPT 1"
N	0	2	–	NPT 1 1/4"
N	0	3	–	NPT 1 1/2"
T	0	1	–	Tri-Clamp flange 1 1/2", straight
T	0	2	–	Tri-Clamp flange 2", straight
V	0	1	–	Varivent flange DN50, straight
<b>O-ring material</b>				
V	i	–	–	FKM Viton® FDA
E	P	–	–	EPDM FDA
K	a	–	–	FFKM Kalrez® 6230 FDA/USP Class VI
<b>Body material</b>				
A	–	–	–	PP conducting (not for 295 mm)
S	–	–	–	DIN 1.4404/316L
<b>Flushing connections</b>				
0	–	–	–	Without
1	–	–	–	Serto ss
2	–	–	–	PVC
3	–	–	–	PVDF
4	–	–	–	Gyrolok™ ss
5	–	–	–	Swagelok ss
<b>Special</b>				
0	–	–	–	Standard
1	–	–	–	Special

**InTrac 77X e**  
Hastelloy and titanium housings have cap nuts made of stainless steel. Varivent and Tri-Clamp flanges are available in stainless steel only.

InTrac 7    /    /    /    /    /    /

Viton and Kalrez are registered trademarks of DuPont Performance Elastomers LLC

# Retractable Housings

Sensor Access Without Process Interruption

Housings

## Product configurator: InTrac 797 e, InTrac 799 e – not all configurations are possible

<b>Flushing chamber</b>																																			
9	Double flushing chamber																																		
<b>Electrode/sensor type</b>																																			
7	pH electrodes with gel/polymer electrolyte and sensors with Pg 13.5 thread																																		
9	Turbidity sensors																																		
<b>Operation mode</b>																																			
M	Manual operation																																		
P	Pneumatic operation																																		
R	Pneumatic operation with pneumatic position indication																																		
I	Pneumatic operation with inductive position indication, non-Ex																																		
X	Pneumatic operation with inductive position indication, Ex																																		
<b>Insertion length (H)</b>																																			
1	0	0	H=100mm																																
<b>Material (wetted parts)</b>																																			
4	4	0	4	DIN 1.4404/AISI 316 L (stainless steel)																															
<b>Process connection</b>																																			
D	0	0	Ingold DN25 weld-in socket																																
T	0	1	Tri-Clamp flange 1 1/2", straight																																
T	0	2	Tri-Clamp flange 2", straight																																
V	0	1	Varivent flange DN50, straight																																
<b>O-ring material</b>																																			
V	i	FKM Viton®-FDA																																	
E	P	EPDM-FDA																																	
K	a	FFKM Kalrez® 6230-FDA/USP Class VI																																	
<b>Body material</b>																																			
A	PP conducting																																		
S	DIN 1.4404/316L																																		
<b>Flushing connections</b>																																			
0	Without																																		
1	Serto ss																																		
4	Gyrolok ss																																		
5	Swagelok ss																																		
<b>Special</b>																																			
0	Standard																																		
1	Special																																		
InTrac 7				/				/					/					/																	
	8	9	10		11	12	13	14	15	16	17	18	19	20	21	22	23	24	25	26	27	28	29	30											

## Product configurator: InTrac 785 – not all configurations are possible

<b>Electrode/Sensor type</b>																																			
5	For pH, turbidity and oxygen sensors (length 425 mm/409 mm/420 mm)																																		
<b>Sensor holder</b>																																			
A	Standard with protective cage (sensor design Ø 12 mm shaft and Pg 13.5 thread)																																		
B	Without protective cage																																		
<b>Flushing chamber</b>																																			
F	Including flushing chamber																																		
N	No flushing chamber																																		
<b>Insertion length</b>																																			
2	2	0	220 mm/8.66" immersion length (Insertion length can be adjusted from 0–220 mm/0"–8.66")***																																
<b>Material (wetted parts)</b>																																			
4	4	3	5	DIN 1.4435/316L																															
C	2	2	-	DIN 2.4602/Alloy C22*																															
T	i	-	-	Titanium*																															
<b>Process connections</b>																																			
N	1	0	NPT 1"																																
N	1	4	NPT 1 1/4" (with adapter 1" to 1 1/4")																																
A	0	2	ANSI A150–1.5" (with adapter 1" NPT to ANSI A150–1.5")																																
D	0	4	DIN DN50–PN16 (with adapter 1" NPT to DIN DN50–PN16)																																
w	/	o	Without ball valve and process connection for direct installation**																																
<b>O-Ring material</b>																																			
V	i	FKM Viton®																																	
K	a	FFKM Kalrez®																																	
<b>Special</b>																																			
-	Standard																																		
S	Special																																		
InTrac 7 8				/				/					/						/																
	10	11	12	13	14	15	16	17	18	19	20	21	22	23	24	25	26	27	28	29	30	31													

\* Ball valve made of SS 1.4408, \*\* For exact ball valve requirements please refer to the instruction manual, \*\*\* Insertion length will be reduced by 40 mm/1.56" by using a flushing chamber.



# EasyClean

## Process Reliability Through Targeted Automation

EasyClean systems are feature-rich and compact. Chemical processing, food processing, bio-pharmaceutical processes, and other industrial applications all benefit from EasyClean's ability to automate routine maintenance. Just choose the most appropriate Ingold sensor, housing, and transmitter for your process, then add an EasyClean system to give you the exact amount of automation you need.

**Flexibility of sensor maintenance**  
 In conjunction with the METTLER TOLEDO Ingold transmitter line, sensor maintenance is fully automated. However, manual operation is also possible whenever required. An integrated controller identifies each ongoing working step, as well as any functional problems within the system.

**Safety**  
 EasyClean carries out continuous system diagnostics. In the event of any system anomaly the electrode remains inserted in the sample medium in order to ensure continued parameter measurement and prevent process interruption.

### System overview EasyClean 400

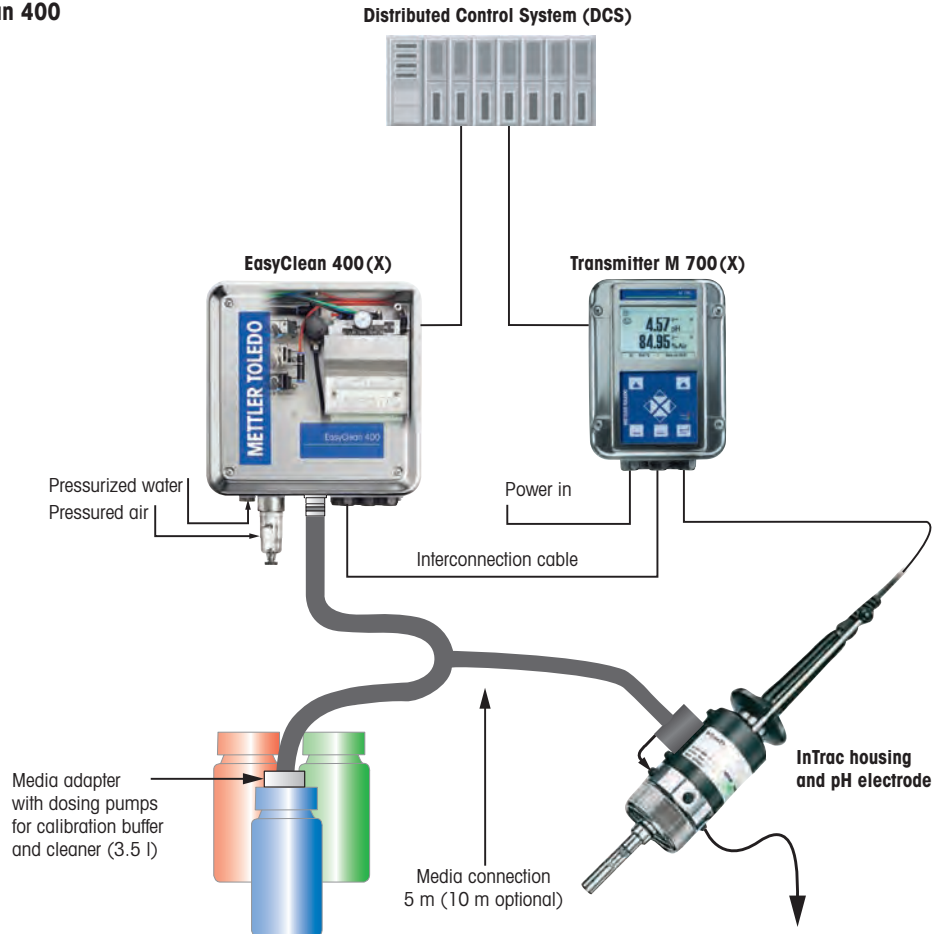



# EasyClean Configuration

## Custom

	EC 400(X)	EC 200e	EC 150	EC 100
<b>Functionality</b>				
Flushing	●	●	●	●
Cleaning	●	●	●	●
Calibration	●	●	●	●
System integration	●	●	●	●
PROFIBUS® PA/FOUNDATION™ fieldbus	●	●	●	●
Ex areas	●	●	●	●
<b>Housing</b>				
InDip 550				●
InTrac 7XXe	1	2	●	●
<b>Transmitter</b>				
M300		●	●	●
M400		●	●	●
M400 2-wire		●	●	●
M700 (X)		●	●	●
M800	●	●	●	●
<b>Sensor</b>				
pH	●	●	●	●
O <sub>2</sub>	●	●	●	●
CO <sub>2</sub>	●	●	●	●
Turbidity	●	●	●	●
Conductivity	●	●	●	●
1 with pneumatic position indicators				
2 with inductive position indicators				

This section will assist you with configuration based upon your specific requirements. The following example creates a fully automated EasyClean system for a “typical” industrial processing application. For harsh chemical environments, choose a compatible industrial sensor housing combination and an EasyClean system to give you the level of automation desired. The ordering information provided on p. 131 will help you choose the appropriate system components. Please make sure you choose one item from each of the sections marked with a ▲.

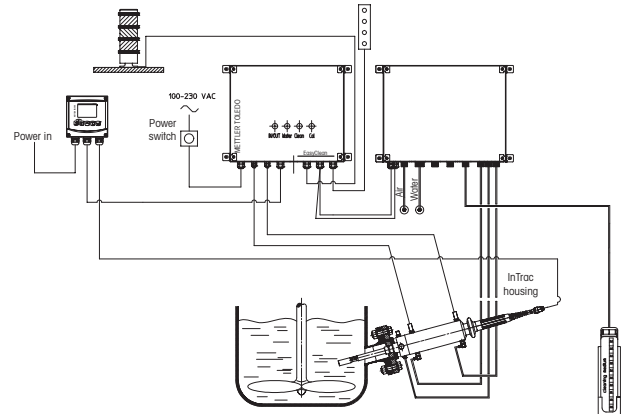

Schematic of a typical EasyClean custom installation

### Configuring your EasyClean system (example)

	Product Description	Order Number	P.
* EasyClean system	EasyClean 200 e	52 403 776	129
Option:	Empty canister (5000 ml)	52 118 063	–
Option:	Connection cable: control unit ▶ transmitter (5 m / 16.4 ft)	52 300 265	131
Option:	Wall mounting kit, complete	52 402 306	131
* Transmitter	M400 Type 1	30 374 111	84
* Sensor cable	VP cable 3 m (9.8 ft)	52 300 108	131
* Sensor	InPro 3250 SG / 225 mm	52 002 560	22
* Housing	InTrac 777 e-I	52 403 216	119

\* Required system component for operation

**Note:** For full functionality, housings must have position sensors when used with an EasyClean 200 e or 400 system.

## EasyClean 400

### Flexible, for the Highest Demands



EasyClean 400 is used for fully automatic cleaning and calibration of pH measuring points. In combination with the transmitter M700 and the InTrac 7XXe retractable housing it provides a flexible system solution which can be implemented into either continuous or batch measurements. EasyClean 400 is versatile in its application. It offers multiple control possibilities and can be programmed extensively. Furthermore, a version for applications in explosion hazardous areas is available. The connection to a supervisory process control system can easily be realized in a conventional way, via PROFIBUS PA or via FOUNDATION fieldbus.

#### Specifications

Protection	IP 65/NEMA 4X
Power	Power supply via M700 Module EC 700 6.8V ( $\pm 10\%$ )/15 mA
Compressed air supply	4–10 bar (58–145 psi)
Flushing supply	2–6 bar (29–87 psi)
Pump	Delivery distance: 5 m/16.4 ft (10 m (32.8 ft) optional) Suction height: 1.5 m/4.9 ft

- **Completely unattended maintenance operation**
- **Allows maintenance teams to focus on more important and skill-intensive tasks**
- **Expanded operations without adding staff**
- **Ensured system performance and process control**

#### Features Overview

- Minimizes maintenance costs by fully automatic cleaning and calibration of the sensor
- Optimal adaptation to the process conditions thanks to diverse program runs with freely programmable sequences
- High flexibility thanks to free choice of individually programmable intervals or weekly programs
- EasyClean 400 ensures a safe application in explosion hazardous areas

▶ [www.mt.com/EC400](http://www.mt.com/EC400)

# EasyClean 200 e

## Fully Automated Rinsing and Cleaning



The EasyClean 200e systems fully automate rinsing and cleaning procedures for the parameters pH, ORP, dissolved oxygen, CO<sub>2</sub>, conductivity, and turbidity.

EasyClean 200e does not feature a calibration option, but it greatly reduces maintenance requirements and improves performance.

### Specifications

Protection	IP 65
Power	100–230 VAC 50/60 Hz 0.18–0.3 A
Compressed air supply	4–8 bar (58–116 psi)
Flushing supply	2–8 bar (29–116 psi)
Pump	Delivery distance: 10 m (32.8 ft) Suction height: 3 m (9.8 ft)

### Features Overview

- Modular configuration provides many installation options
- Many accessories available for customized installation and operational requirements

### Other Highlights

- Configured for immediate operation
- Easily customized for special requirements
- Manual operation override if desired
- Fully automated operation for pH, ORP, dissolved oxygen, CO<sub>2</sub>, conductivity, and turbidity
- Optimal cleaning effect due to the adjustable residence time

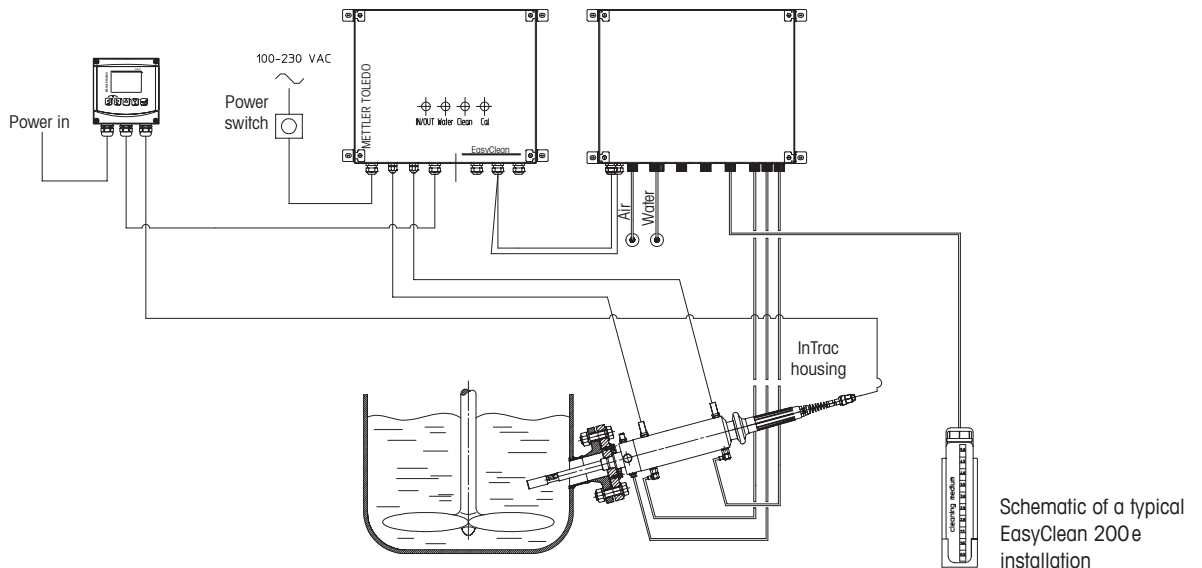

Schematic of a typical EasyClean 200e installation

## EasyClean 150/100 Automated Rinsing

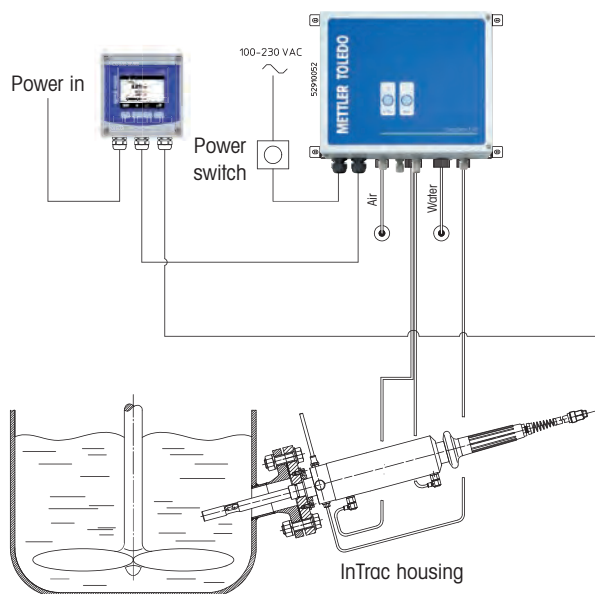

Schematic of a typical EasyClean 150 installation

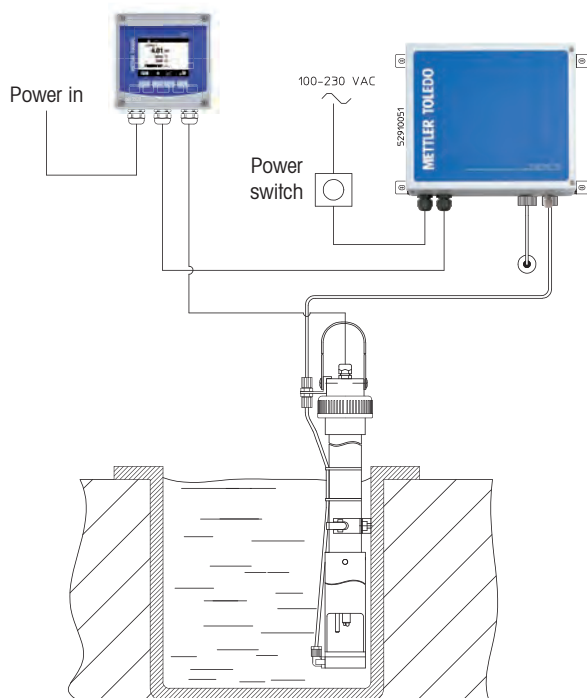

Schematic of a typical EasyClean 100 installation

The EasyClean 100 and 150 series are designed to provide completely automatic sensor rinsing. The EasyClean 100 system is designed to be used with a stationary InDip housing with a spray-head for open tank and basin applications. The EasyClean 100 can use either water rinsing or compressed air to create turbulence to prevent stubborn build-up. The EasyClean 150 works in conjunction with a retractable housing to withdraw the electrode from the process prior to automatic water rinsing.

### Specifications

Protection	IP 65
Power	100–230 VAC 50/60 Hz 0.18–0.3 A
Compressed air supply	4–8 bar (58–116 psig) (EasyClean 150)
Flushing supply	2–6 bar (29–87 psig)

### Features Overview

- Modular design allows complete flexibility
- Universal components for easy serviceability
- Entry-level – moderate fouling environments

### Other Highlights

- Simple design and fast setup
- Standard program for immediate operation
- Manual operation override if desired



EasyClean 100 cleaning action. The bubble formation centered beneath the sensor guarantees gentle cleaning.

▶ [www.mt.com/EC150](http://www.mt.com/EC150)  
▶ [www.mt.com/EC100](http://www.mt.com/EC100)

### ▲ EasyClean Systems

Product	100	150	200 e	400 (X)	Order Number
EasyClean 100	•	–	–	–	52 402 304
EasyClean 150	–	•	–	–	52 402 319
EasyClean 200 e	–	–	•	–	52 403 776
EasyClean 400 C	–	–	–	•	52 403 596
EasyClean 400 S	–	–	–	•	52 403 598
EasyClean 400 XC	–	–	–	•	52 403 597
EasyClean 400 XS	–	–	–	•	52 403 599

### ▲ Transmitters

M300 Process transmitter	•	•	•	–	See transmitter section
M400 transmitter	•	•	•	–	See transmitter section
M400 2-wire transmitter	•	•	•	–	See transmitter section
M700 (X) transmitter	–	–	–	•	See transmitter section
EC 700 module (to control EC 400)	–	–	–	•	See transmitter section
M800 transmitter	•	•	•	–	See transmitter section

### ▲ Sensor

pH	•	•	•	•	See all sensors
Dissolved oxygen, turbidity, conductivity, CO <sub>2</sub>	•	•	•	–	See all sensors

### ▲ Sensor Cable

VP cable–ST/3 m (9.8 ft) (pH, DO and CO <sub>2</sub> )	•	•	•	•	52 300 108
VP cable–ST/1.5 m (4.9 ft) (conductivity)	•	•	•	–	58 080 201
Extended length VP cable–(pH, DO and CO <sub>2</sub> )	•	•	•	•	See p. 134
Extended length VP cable–(conductivity)	•	•	•	–	See p. 134

### ▲ Sensor Housings

InTrac 7XXe	–	•	•②	•③	See housings section
InDip 550	•	–	–	–	See housings section
Spray head for InDip 550 (PVC)	•	–	–	–	52 402 291
Spray head for InDip 550 (PVDF)	•	–	–	–	52 402 290

### Calibration Supplies

Buffer pH 4.01, 5000 ml	–	–	–	•	51 319 012
Buffer pH 7.00, 5000 ml	–	–	–	•	51 319 016
Buffer pH 9.21, 5000 ml	–	–	–	•	51 319 017

### Options

Transmitter cable 5 m (16.4 ft)	•	•	•	–	52 300 265
Transmitter cable 10 m (32.8 ft)	•	•	•	–	52 300 266
Compressed air hose LDPE 20 m (65.6 ft)	•	•	•	–	52 402 314
Pneumatic hose PU 6/4 mm	–	•	•	–	52 401 322
Fittings pneumatic/hydraulic	–	•	•	–	52 402 337
Wall-mount kit	•	•	•	–	52 402 306
Post-mount kit	•	•	•	–	52 402 308
Weatherproof hood	•	•	•	–	52 402 316
Power switch button	•	•	•	•	52 402 317

▲ One item required for system operation  
Position indicators not required

② Inductive position indicators required









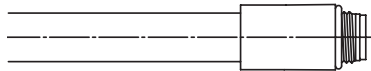
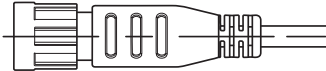

③ Pneumatic position indicators required

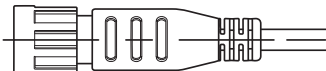
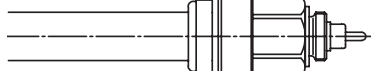
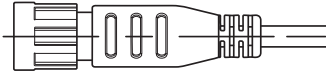
## Cables and Connections Sensor Heads/Cable Sockets

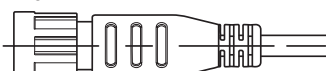
Interconnection cables from the sensor to the transmitter play an important role in providing reliable process measurements. In addition to carrying the particular parameter signal, in some cases temperature, solution ground and supply voltages are also required. Internal cable shielding and appropriate cable connectors assure noise-free, reliable signal transfer. A wide variety of cables is available to meet

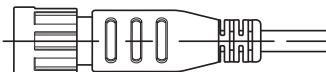
the specific installation requirement. Below is a listing of common cables. The sensor head connection is shown below in the left column with the corresponding cable connection shown directly to the right.

Available sensor / cable adapters are listed on p. 133. Contact METTLER TOLEDO for additional configurations and custom application requirements.

Sensor Heads	Adapters (see next page)	Cable Sockets	Parameter
S7 		AS9 	pH/redox
S8 (with Pg 13.5) 		AS9 	pH/redox
K8S (with Pg 13.5 autoclavable) 		AK9 	pH/redox
ISM: K8S 		AK9 	pH/redox/DO
K9 (autoclavable) 		AK9 	pH/redox
VP6/VP8 sensor head 		VP6/VP8 cable socket 	pH/redox/DO/ CO <sub>2</sub> /Cond
O <sub>2</sub> flange plug type T-82 		O <sub>2</sub> cable socket T-82 	DO



### Did You Know





The VP cable blind plug keeps the cable socket dry when the sensor is removed for service.

# Cable Terminations

## Custom Cable Plugs to Transmitter or Appliances

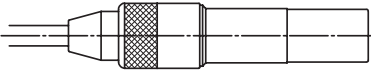
Note: Standard cables are delivered with one end open for transmitter connection. On request, cable plugs can be ordered for different appliances.

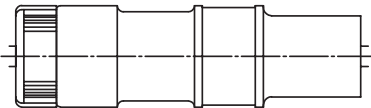
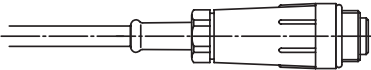
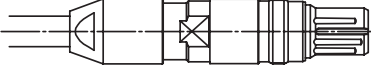
The most commonly used plugs are shown below. Ask for other types from your METTLER TOLEDO representative.

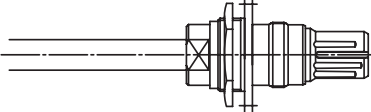
Applications		Parameter
Appliance coupler DIN 15.50D Coaxial plug (DIN 19262) for 5 mm cable		pH/redox
Appliance coupler BNC-50 Coaxial plug for 5 mm cable		pH/redox
Coax connector for gas- and watertight connection of 2 coaxial 5 mm cables		pH/redox
Cable coupler SK9 for lengthening of AS9 5 mm cable		pH/redox
VP plug		pH/redox/DO/CO <sub>2</sub>
VP blind plug		pH/redox/DO/CO <sub>2</sub>
VP apparatus plug Connection as flange or bulkhead		pH/redox/DO/CO <sub>2</sub>

### Cable/Sensor Adapters and Cable Plugs

Description	Order Number
Adapter, to connect from K8S or K9 sensor head to AS9 cable	59 900 227
Adapter, to connect from S7 or S8 sensor head to AK9 cable	59 900 195
Adapter, to connect from T-82 sensor head to VP cable	52 200 940
Adapter, to connect from VP sensor head to T-82 cable	52 200 939
VP cable blind plug	52 300 252

# Cables and Connections/Cable Terminations

Solid Connections for Safe Operation

Cables

### Cable Availability Cross Reference Table

	<b>AS9 Cables with S7 or S8 Connector</b>								<b>Conductivity VP Sensor Cables</b>								<b>Cables with Type 82 Connector</b>			
	Termination	Length	Termination	Length	Termination	Length	Termination	Length	Termination	Length	Termination	Length	Termination	Length	Termination	Length				
	Tinned Ends	1 m (3.3 ft)	Tinned Ends	3 m (9.8 ft)	Tinned Ends	5 m (16.4 ft)	Tinned Ends	10 m (32.8 ft)	Tinned Ends	1 m (3.3 ft)	Tinned Ends	3 m (9.8 ft)	Tinned Ends	5 m (16.4 ft)	Tinned Ends	10 m (32.8 ft)				
	BNC	BNC	BNC	DIN	DIN	DIN	DIN	DIN	Tinned Ends	1.5 m (4.9 ft)	Tinned Ends	3 m (9.8 ft)	Tinned Ends	4.5 m (14.8 ft)	Tinned Ends	15 m (49.2 ft)				
	BNC	BNC	DIN	DIN	DIN	DIN	DIN	DIN	Tinned Ends	1.5 m (4.9 ft)	Tinned Ends	3 m (9.8 ft)	Tinned Ends	4.5 m (14.8 ft)	Tinned Ends	15 m (49.2 ft)				
	BNC	BNC	DIN	DIN	DIN	DIN	DIN	DIN	Tinned Ends	1.5 m (4.9 ft)	Tinned Ends	3 m (9.8 ft)	Tinned Ends	4.5 m (14.8 ft)	Tinned Ends	15 m (49.2 ft)				
	BNC	BNC	DIN	DIN	DIN	DIN	DIN	DIN	Tinned Ends	1.5 m (4.9 ft)	Tinned Ends	3 m (9.8 ft)	Tinned Ends	4.5 m (14.8 ft)	Tinned Ends	15 m (49.2 ft)				
InPro 2000																				
InPro 3100																				
InPro 3100 UD																				
InPro 3250 SG																				
InPro 3250																				
InPro 3251																				
InPro 3252																				
InPro 3253 SG																				
InPro 3253																				
InPro 3300																				
InPro 4010																				
InPro 4260 SG																				
InPro 4260																				
InPro 4262																				
InPro 4501																				
InPro 4550																				
InPro 4800 SG																				
InPro 4800																				
InPro 4801 SG																				
InPro 4802																				
DXK	•	•	•	•	•	•	•	•	•											
DPA	•	•	•	•	•	•	•	•	•											
DPAS																				
pH/ORP ISM (1-wire)																				
Puncture	•	•	•	•	•	•	•	•	•											
InPro 6050																				
InPro 6800																•	•			
InPro 6800 GAS																•	•			
InPro 6810																				
InPro 6820																•	•			
InPro 6830																•	•			
InPro 6850 i																•	•			
InPro 6900 i																				
InPro 6900																				
InPro 6910																				
InPro 6950 i																				
InPro 6950																				
DO ISM (1-wire)																				
InPro 6950 GAS																				
O <sub>2</sub> Gas ISM (1-wire)																				
InPro 5000																				
InPro 5000 i																				
InPro 7000										•	•	•	•	•	•	•	•			
InPro 7000 i										•	•	•	•	•	•	•	•			
InPro 7001										•	•	•	•	•	•	•	•			
InPro 7002										•	•	•	•	•	•	•	•			
InPro 7005										•	•	•	•	•	•	•	•			
InPro 7108										•	•	•	•	•	•	•	•			

Order Number  
 59 902 245  
 59 902 268  
 59 902 292  
 59 902 318  
 59 902 246  
 59 902 269  
 59 902 319  
 59 902 243  
 59 902 266  
 59 902 290  
 59 902 316  
 58 080 201  
 58 080 202  
 58 080 203  
 58 080 204  
 58 080 205  
 58 080 206  
 58 080 207  
 59 906 837  
 59 906 839  
 59 906 841  
 59 906 842  
 59 906 844

For other available cables, please check with your METTLER TOLEDO representative.



-30 to 80°C / -22 to 176 °F												-40 to 135°C / -40 to 275 °F												
Variopin (VP) Cables						Variopin (VP) Cables						Variopin (VP) for InPro 3300 (ISPE1)						AK9 Cables with K9 or K85 Connector						
Termination	Length	Termination	Length	Termination	Length	Termination	Length	Termination	Length	Termination	Length	Termination	Length	Termination	Length	Termination	Length							
Tinned Ends	1 m (3.3 ft)	Tinned Ends	1 m (3.3 ft)	Tinned Ends	1 m (3.3 ft)	Tinned Ends	1 m (3.3 ft)	Tinned Ends	1 m (3.3 ft)	Tinned Ends	1 m (3.3 ft)	Tinned Ends	1 m (3.3 ft)	Tinned Ends	1 m (3.3 ft)	Tinned Ends	1 m (3.3 ft)							
Tinned Ends	3 m (9.8 ft)	Tinned Ends	3 m (9.8 ft)	Tinned Ends	3 m (9.8 ft)	Tinned Ends	3 m (9.8 ft)	Tinned Ends	3 m (9.8 ft)	Tinned Ends	3 m (9.8 ft)	Tinned Ends	3 m (9.8 ft)	Tinned Ends	3 m (9.8 ft)	Tinned Ends	3 m (9.8 ft)							
Tinned Ends	5 m (16.4 ft)	Tinned Ends	5 m (16.4 ft)	Tinned Ends	5 m (16.4 ft)	Tinned Ends	5 m (16.4 ft)	Tinned Ends	5 m (16.4 ft)	Tinned Ends	5 m (16.4 ft)	Tinned Ends	5 m (16.4 ft)	Tinned Ends	5 m (16.4 ft)	Tinned Ends	5 m (16.4 ft)							
BNC	10 m (32.8 ft)	BNC	10 m (32.8 ft)	BNC	10 m (32.8 ft)	BNC	10 m (32.8 ft)	BNC	10 m (32.8 ft)	BNC	10 m (32.8 ft)	BNC	10 m (32.8 ft)	BNC	10 m (32.8 ft)	BNC	10 m (32.8 ft)							
BNC	3 m (9.8 ft)	BNC	3 m (9.8 ft)	BNC	3 m (9.8 ft)	BNC	3 m (9.8 ft)	BNC	3 m (9.8 ft)	BNC	3 m (9.8 ft)	BNC	3 m (9.8 ft)	BNC	3 m (9.8 ft)	BNC	3 m (9.8 ft)							
BNC	5 m (16.4 ft)	BNC	5 m (16.4 ft)	BNC	5 m (16.4 ft)	BNC	5 m (16.4 ft)	BNC	5 m (16.4 ft)	BNC	5 m (16.4 ft)	BNC	5 m (16.4 ft)	BNC	5 m (16.4 ft)	BNC	5 m (16.4 ft)							
DIN, banana	10 m (32.8 ft)	DIN, banana	10 m (32.8 ft)	DIN, banana	10 m (32.8 ft)	DIN, banana	10 m (32.8 ft)	DIN, banana	10 m (32.8 ft)	DIN, banana	10 m (32.8 ft)	DIN, banana	10 m (32.8 ft)	DIN, banana	10 m (32.8 ft)	DIN, banana	10 m (32.8 ft)							
DIN, banana	3 m (9.8 ft)	DIN, banana	3 m (9.8 ft)	DIN, banana	3 m (9.8 ft)	DIN, banana	3 m (9.8 ft)	DIN, banana	3 m (9.8 ft)	DIN, banana	3 m (9.8 ft)	DIN, banana	3 m (9.8 ft)	DIN, banana	3 m (9.8 ft)	DIN, banana	3 m (9.8 ft)							
DIN, banana	5 m (16.4 ft)	DIN, banana	5 m (16.4 ft)	DIN, banana	5 m (16.4 ft)	DIN, banana	5 m (16.4 ft)	DIN, banana	5 m (16.4 ft)	DIN, banana	5 m (16.4 ft)	DIN, banana	5 m (16.4 ft)	DIN, banana	5 m (16.4 ft)	DIN, banana	5 m (16.4 ft)							
																		InPro 2000						
																		InPro 3100						
																		InPro 3100 UD						
																		InPro 3250 SG						
																		InPro 3250						
																		InPro 3251						
																		InPro 3252						
																		InPro 3253 SG						
																		InPro 3253						
																		InPro 3300						
																		InPro 4010						
																		InPro 4260 SG						
																		InPro 4260						
																		InPro 4262						
																		InPro 4501						
																		InPro 4550						
																		InPro 4800 SG						
																		InPro 4800						
																		InPro 4801 SG						
																		InPro 4802						
																		DXK						
																		DPA						
																		DPAS						
																		pH/ORP ISM (1-wire)						
																		Puncture						
																		InPro 6050						
																		InPro 6800						
																		InPro 6800 GAS						
																		InPro 6810						
																		InPro 6820						
																		InPro 6830						
																		InPro 6850 i						
																		InPro 6900 i						
																		InPro 6900						
																		InPro 6910						
																		InPro 6950 i						
																		InPro 6950						
																		DO ISM (1-wire)						
																		InPro 6950 GAS						
																		O <sub>2</sub> Gas ISM (1-wire)						
																		InPro 5000						
																		InPro 5000 i						
																		InPro 7000						
																		InPro 7000 i						
																		InPro 7001						
																		InPro 7002						
																		InPro 7005						
																		InPro 7108						



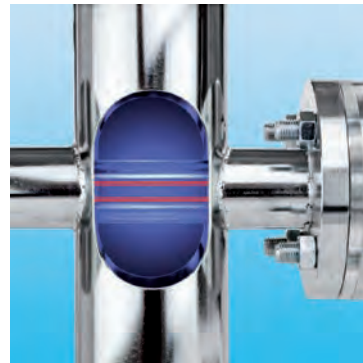
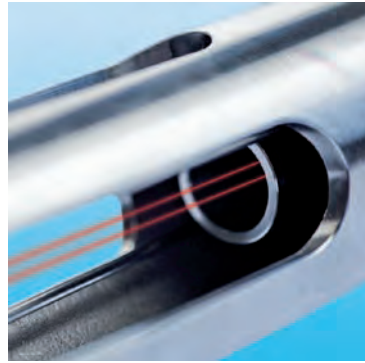

# Gas Analytics Measurement Solutions for Industrial Applications

## Gas Analyzers

### Measure Where It Really Matters

**Monitoring and controlling the level of harmful or explosive gases in your process is key to ensuring the safety of the environment, people, assets and increasing process efficiency. METTLER TOLEDO's unique range of gas analysis solutions gives you the power to decide where to measure, everywhere it matters.**

Based on long-standing field experience in analytical solutions for liquid measurement, METTLER TOLEDO has developed systems for gas analysis that offer:

- **In situ and in-line capability:** our systems are built to measure, right there where you need to measure
- **Low cost of ownership:** outstanding measurement performance without the drawback of heavy maintenance
- **Ruggedness and long-term stability** for continuous use in the harshest environments.

#### The best technology for the job

METTLER TOLEDO's choice of technologies for gas measurement all feature the ability to measure in situ, without the need for gas sampling or conditioning.

- GPro® 500 **Tunable Diode Laser (TDL)** analyzers provide the highest level of reliability and fastest response time in process control and safety applications.
- Membrane covered InPro **amperometric oxygen sensors** are largely

insensitive to moisture and dust: they are ideally suited for inerting and blanketing applications.

#### TDL: Laser-sharp view into your process

With TDL absorption spectroscopy, a diode laser with a highly specific and extremely narrow emission wavelength is used to resolve single absorption lines of the gas species to be measured. The absorption lines are carefully selected to avoid cross-interference from other background gases. Using direct absorption spectroscopy, a spectrum is taken and compared with spectral reference data stored in the on-board database for any given temperature and pressure. The concentration of the gas is then calculated, and any inconsistency between reference data and measurement will trigger an alarm.

#### Process adaptations that fit anywhere

Many users want to reap the benefits of interference-free, drift-free TDL tech-

nology for better process control and lower maintenance costs. However, for reliable measurement with a TDL, necessary framework conditions such as minimum optical path length, availability of purge gas supply, or high dust load in a process can sometimes get in the way. Acknowledging these constraints, METTLER TOLEDO has developed specific adaption solutions to substantially increase the coverage of possible TDL applications.

The new wafer-type adaption allows cross-section installation down to DN50 (2") pipes with no flow restriction and minimum pipe work required. Further, static process gas conditions are not an obstacle to the GPro 500 with the availability of the new process purge-free probe for inertization and blanketing applications. Finally, the filter probe is ideal for measurement in high-dust applications where cross-stack-type TDLs typically fail due to the loss of signal intensity.



**New gases, new opportunities for process and combustion applications:**

**Oxygen:**

- Blanketing and inertization
- Combustion control
- Reformers
- Chlorination
- Flare stacks
- Thermal oxidizer
- Vapor recovery
- Formaldehyde

**CO:**

- Combustion
- ESP filter
- CO boiler
- FCC units

**CO<sub>2</sub>:**

- FCC units
- Ethylene oxide (EO)
- Ethylene
- PTA plant

**- Syngas**

- Ammonia
- Fired heaters
- Process heaters
- Carbon black
- Ethylene
- Hydrogen production

**CH<sub>4</sub>:**

- Syn gas

**CO/CH<sub>4</sub>:**

- Combustion

**H<sub>2</sub>O:**

- Chlorine gas
- H<sub>2</sub> reformer gas
- Tower dryer exhaust

**H<sub>2</sub>O:**

- Chlorine gas
- H<sub>2</sub> reformer gas
- Tower dryer exhaust

**H<sub>2</sub>S:**

- Sulfur recovery

**NH<sub>3</sub>:**

- Ammonia slip

**HCl:**

- Stack monitoring



▶ [www.mt.com/gas](http://www.mt.com/gas)

**InPro 6800G/ InPro 6850iG    InPro 6900iG    InPro 6950iG    GPro 500**

<b>Industrial Processes</b>	<b>InPro 6800G/ InPro 6850iG</b>	<b>InPro 6900iG</b>	<b>InPro 6950iG</b>	<b>GPro 500</b>
<b>Chemical Industry</b>				
Inerting	•	•	•	•
Blanketing	•	•	•	•
Process / safety				•
Vapor recovery	•	•		•
Thermal oxidizer / process heaters				•
Flare				•
<b>Food and Beverage Industry</b>				
CO <sub>2</sub> recovery			•	
<b>Petrochemical</b>				
Flue gas				•
Flares				•
Process / safety				•
ESP filters				•
Combustion				•

**Application guide for gas analyzers (for more application examples, visit [www.mt.com/GPro500-eBook](http://www.mt.com/GPro500-eBook))**

## Comparison of Oxygen Measurement Technologies Selection Criteria to Help You Choose the Right Tool

**There is no single measurement technology that will work for every application. METTLER TOLEDO is dedicated to identifying and offering the best technologies for robust in process gas measurements. For making oxygen measurements, we have three technologies. The following is a general guideline for selecting the best technology. To make the final determination, please contact your local METTLER TOLEDO representative.**

### Oxygen measurement across the process industries

From preventing the build-up of explosive gas mixtures in chemical processes, to nitrogen blanketing for inhibiting product oxidation, to ensuring carbon dioxide purity in the Food and Beverage industry, measurement of oxygen is a vital element of many industrial processes.

### Amperometric

This is an electro-chemical measurement technology housed in a compact package. It is a depleting technology, some maintenance and consumables is required. Chemical interferences are possible; knowledge of the gas composition is required for evaluation.

For more information on this technique, refer to the Measurement Theory section of this catalog.

### Tunable Diode Laser (TDL)

METTLER TOLEDO's TDL technology is immune to most interferences and the sensor's materials of construction are quite robust. There is no regular maintenance and the sensor is designed for long term continuous operation while

being virtually drift free. TDL is suited for the most challenging and critical applications. The physical package is a bit larger than the amperometric and optical sensors. For more information on this technique, refer to the Measurement Theory section of this catalog.

	Amperometric	TDL Oxygen
<b>Applications</b>	Inerting & Blanketing	Process Control, Safety & Combustion
<b>Flow required</b>	No, great for tank inerting	Certain applications require flow
<b>Range</b>	5-50,000 ppm or 50 ppm to 60%	0.01 – 100%
<b>Max temperature</b>	70 °C (158 °F)	600 °C (1112 °F)
<b>Low pressure</b>	-0.81 bar (-11.8 psig)	-0.7 bar (-10.15 psig)
<b>High pressure</b>	+7.95 bar (115.3 psig)	+9 bar (130.53 psig)
<b>N<sub>2</sub> purging required</b>	No	Sometimes
<b>Maintenance, consumables</b>	Required	No
<b>Capital</b>	\$	\$\$\$
<b>Probe size</b>	Very small, for confined spaces	Larger, for pipes 2" dia. or larger
<b>Hazardous area technique</b>	Intrinsic safety	Explosion proof
<b>Background gas interference</b>	Susceptible to some	None
<b>SIL</b>	No	SIL2 compatible version available
<b>ATEX/FM Approved</b>	Yes	Yes

# TDL Gas Analyzers

For Every Installation Location in Your Plant



**Standard Purged    Wafer    Non-Purge    Non-Purged with filter and Blow-back    Extractive    Cross-Pipe**

<b>Optical Path Interface</b>	Insertion probe	Flow thru. Body is part of pipeline system	Insertion probe	Insertion probe	Extractive cell	Full diameter
<b>Min Flow Requirement</b>	Yes	Yes	No	Yes	No	Yes
<b>Process Interface/Size</b>	Mounts in pipe 4" diameter or larger	2", 150 lb ANSI or 3", 150 lb ANSI or 4", 150 lb ANSI	Mounts in pipe 4" diameter or larger	Mounts in pipe 4" diameter or larger	N/A	Pipes 1–3 m diameter
<b>Typical Application</b>	Near saturated gas stream e.g. combined gas vent line to destruct unit	Near saturated gas stream e.g. dryer, solvent, vapor recovery	Clean dry gases e.g. Storage tank safety blanket	Dry gases with particulate e.g. Flue gases	Clean dry gases from customer's extractive gas sampling system e.g. marine vapor recovery	Hot, flue gases, e.g. ammonia slip/ducts, and stacks

## Transmitter version

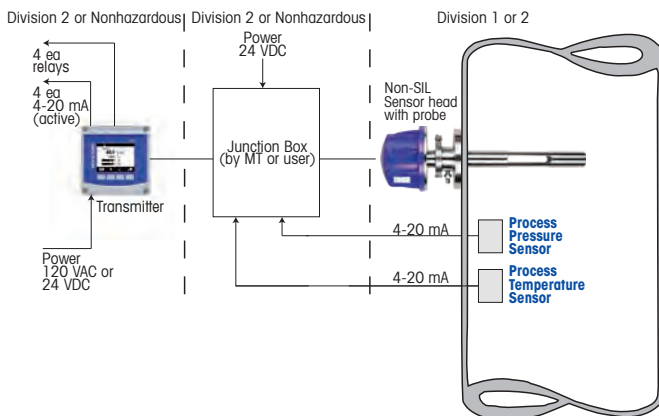

## Direct analog out version

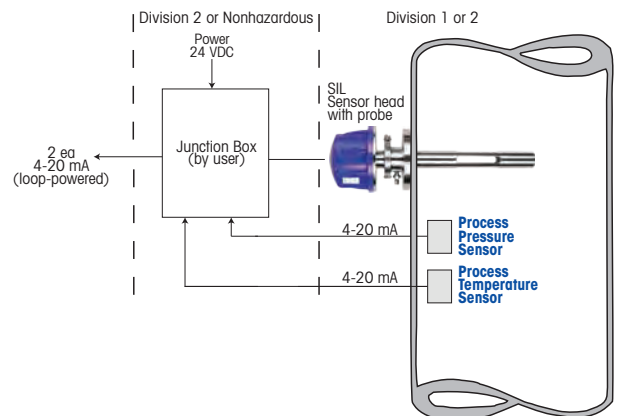

## GPro 500 TDL Building Your Measurement System

### Selection of Components

For proper operation and optimal performance in your process, each element of your measurement system must be carefully chosen. A complete measurement system requires components including a sensor, junction box, cable and transmitter.

### Sensor Selection

METTLER TOLEDO sensors are high performance and long lasting. However, proper selection must be made according to the application and process environment to which it will be exposed.

Basic selection considerations are:

- Gas to be measured
- Measurement range
- Operating temperature/pressure range
- Alarm level
- Accuracy required
- Background gases & concentrations
- Ambient temperature
- Contaminants (particulates, oils, condensate, aerosols)
- Piping/vessel sizes
- Gas stream velocity
- Dust and particle content

The sensor is made up of two significant pieces, as discussed below:

### 1a. Sensor-Spectrometer Portion (head)

Once it has been determined that we can successfully make the desired measurement, selection of correct head is relatively simple

Choices include:

- Gas to be measured (presently O<sub>2</sub>, CO, CO<sub>2</sub>, HCl, H<sub>2</sub>S, CH<sub>4</sub> CO/CH<sub>4</sub>, CH<sub>4</sub>, NH<sub>3</sub> and H<sub>2</sub>O vapor)
- Safety approval type (FM or ATEX)
- Requirement for SIL2

### 1b. Sensor – Process Adaption Portion

Upon detailed review of the process conditions and using our many years of experience, we select the best style adaption for the application and the appropriate size.

This is a brief summary of the process adaption styles (each available in various sizes):

- Purged probe
- Non-purged probe
- Non-purged probe with filter and optional blowback
- Wafer
- Extractive
- White cell

In addition to the sensor style and size, other decisions include:

- Seal material (Kalrez® types or graphite)
- Optic material (borosilicate glass, quartz or sapphire)
- Wall thickness (to accommodate wall insulation)
- Process connection size
- Material of construction: 316L, 316Ti stainless steel and C22 Hastelloy are standard; others are available on request.





## 2. Transmitter Selection

Transmitters are the component that communicates a sensor's readings into displayed measurements. The transmitter also transfers the data to the process control system.

Most users want the convenience of having a local display, multiple analog inputs/outputs and alarms. For these users we select the model M400, Type 3 transmitter. This 4 wire transmitter is ATEX/FM approved for Zone/Division 2 areas, is suitable for indoor or outdoor use and can be powered from AC or DC.

If your site requires a SIL version of the GPro 500, that version does not utilize the separate (M400) transmitter. The SIL version of the GPro 500 has a simple transmitter built into the sensor's head. It does not have the functionality of the M400, it simply has 2 analog (4–20mA) signal outputs (loop powered).

## 3. Junction Box

The multi-core cable that connects on one end to the GPro 500 head terminates the other end at a junction box that houses a 16 position terminal strip. METTLER TOLEDO offers a junction box or users can provide their own junction box. The junction box needs to be rated for the area where it will be installed.

## 4. Cable

A multi-core cable is used to connect the GPro 500 head to the junction box. Note: on the FM unit, the cable is shipped loose, the ATEX unit has the cable pre-terminated in the sensor's head.

## 5. Verification Cell

Although not part of the GPro 500, a verification cell is a useful tool to verify calibration and for troubleshooting.

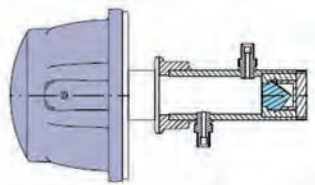

To use the cell, remove the sensor head from the probe and connect the cell to the head using the Tri-Clamp and special gasket. One verification cell can be used for multiple units on the same site. Ambient air can be used as a check gas for the oxygen sensor. To introduce other gases, the cell has inlet and outlet fittings.

## 6. Diagnostic Software

The MT TDL Suite is PC software with a variety of functions to see into and capture information about the operation of your GPro 500. It is not mandatory to ever use this software but most users find it a powerful tool. The software suite will automatically detect the gas that your unit is designed to measure and will display it appropriately. A CD containing the MT TDL Suite is shipped along with the GPro 500.



## 7. Thermal Barrier

If the process gas is expected to be at a temperature between 250 °C to 600 °C, a thermal barrier can be used to protect the sensor's electronics. The thermal barrier is effectively a spool piece mounted between the sensor and the sensor head.

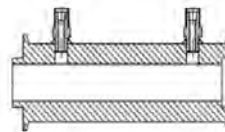

## GPro 500 Sensor

In Situ Sensor Convenience, with the Power of an Analyzer



Tunable Diode Laser (TDL) measurement technology is recognized for speed and accuracy of measurement, and immunity to background gases. To this, METTLER TOLEDO has added the simplicity of use and low maintenance of in-line sensor design, plus advanced predictive diagnostics. The result is the GPro 500 series, a highly durable line of oxygen sensors for process and safety applications in chemical plant and petrochemical operations.

### Specifications

#### Measurement O<sub>2</sub>

Effective path length	Probes: 200, 400, 800 mm (7.87", 15.75", 31.49")
	Water: 50, 80, 100 mm (1.96", 3.15", 3.94")
	Extractive cells: 200, 400, 800 mm, 1 m, 10 m (7.87", 15.75", 31.49", 39.37", 393.70")
Lower detection limit (in 1 meter path length at ambient standard conditions, dry gas, no dust load, in N <sub>2</sub> background)	100 ppm-v
Measurement range	0–100%
Accuracy	2% of reading or 100 ppm O <sub>2</sub> , whichever is greater
Linearity	Better than 1%
Resolution	<0...0.01% vol O <sub>2</sub> (100 ppm-v)
Drift	Negligible (<2% of measurement range between maintenance intervals)
Sampling rate	1 second
Response time (T <sub>90</sub> )	O <sub>2</sub> in N <sub>2</sub> 21% >0% in <2 sec
Warm up time	Typically <1 minute
Repeatability	±0.25% of reading or 0.05% O <sub>2</sub> (whichever is greater)
Process pressure range	0.3 bar–10 bar (abs)* / 4.35 psi–145.03 psi (abs)
Process temperature range	0–250 °C (32–482 °F) Optional (for probe installation) 0–600 °C (0–1112 °F) with additional thermal barrier

\* firmware 6.23 or higher

### Features Overview

- One-flange installation without alignment
- In situ measurement without sampling system
- Low cost-of-ownership with virtually no maintenance
- Low purge gas consumption for minimum operating costs
- Large choice of process interface options



### Did You Know

Tunable Diode Laser spectrometers are insensitive to background interference from the process gas and moisture, and are largely resistant to heavy dust loads.

▶ [www.mt.com/GPro500](http://www.mt.com/GPro500)

**Measurement (All measurement specifications with reference to standard conditions T & P with no dust or particulates) and 1 m optical path**

	O <sub>2</sub>	CO (ppm)	CO (%)	H <sub>2</sub> O	H <sub>2</sub> O ppm	CO <sub>2</sub> (%)
Effective path length	<b>Probes:</b> 200, 400, 800 mm (7.87", 15.75", 15.75", 31.50"). <b>Wafer Cell:</b> 104 mm, 110 mm, 154 mm, 164 mm, 214 mm (4.09", 4.33", 6.06", 6.46", 8.43") <b>Extractive cells:</b> 200 mm, 400 mm, 800 mm, 1 m, 8 m (7.87", 15.75", 31.50", 39.37", 315")					
Measurement range and standard conditions <sup>1)</sup>	0–100%	0–2%	0–100%	0–20%	0–1%	0–100%
Lower Detection Limit <sup>2)</sup>	100 ppm-v	1 ppm-v	1500 ppm-v	5 ppm-v	1 ppm-v	1000 ppm-v
Accuracy	2% of reading or 100 ppm O <sub>2</sub> , whichever is greater	2% of reading or 1 ppm, whichever is greater	2% of reading or 1500 ppm, whichever is greater	2 % of reading or 10 ppm, whichever is greater	2% of reading or 1 ppm, whichever is greater	2% of reading or 1000 ppm, whichever is greater
Linearity	Better than 1%	Better than 1%	Better than 1%	Better than 1%	Better than 1%	Better than 1%
Resolution	<0...01% vol O <sub>2</sub> (100 ppm-v)	1 ppm-v	1500 ppm-v	5 ppm-v	1 ppm-v	1000 ppm-v
Drift	Negligible (<2% of measurement range between maintenance intervals)					
Sampling rate	1 second	1 second	1 second	1 second	1 second	1 second
Response time (T90)	O <sub>2</sub> in N <sub>2</sub> 21% >0% in <2 sec	CO in N <sub>2</sub> 300 ppm-v to 0% in <4 sec	CO in N <sub>2</sub> 1% to 0% in <4 sec	H <sub>2</sub> O in N <sub>2</sub> 1% to 0% in <4 sec	H <sub>2</sub> O in N <sub>2</sub> 1% to 0% in <4 sec	CO <sub>2</sub> in N <sub>2</sub> 1% to 0% in <4 sec
Warm-up time	Typically <1 hour	Typically <1 hour	Typically <1 hour	Typically <1 hour	Typically <1 hour	Typically <1 hour
Repeatability	±0.25% of reading or 0.05% O <sub>2</sub> , whichever is greater	±0.25% of reading or 5 ppm-v CO, whichever is greater	±0.25% of reading or 0.75%-v CO, whichever is greater	±0.25% of reading or 50 ppm-v H <sub>2</sub> O, whichever is greater	±0.25% of reading or 10 ppm-v CO, whichever is greater	±0.25% of reading or 5000 ppm-v CO <sub>2</sub> , whichever is greater
Process pressure range	0.1 bar to 10 bar (abs)*/ 4.35 psi to 145.03 psi (abs)	0.8 bar to 2 bar (abs)/ 11.6 psi to 29.psi (abs)	0.8 bar to 1.5 bar (abs)/ 11.6 psi to 21.7.psi (abs)	0.8 bar to 2 bar (abs)/ 11.6 psi to 29.psi (abs)	0.8 bar to 2 bar (abs)/ 11.6 psi to 29.psi (abs)	0.8 bar to 2 bar (abs)/ 11.6 psi to 29 psi (abs)
Process temperature range	0 to +250 °C (+32 to +482 °F) Optional (for probe installation). 0 to +600 °C (0 to +1112 °F) with built in thermal barrier. 0 to +150 °C (+32 to +302 °F) (White cell)					
	* firmware 6.23 or higher					

	CO ppm/CH <sub>4</sub> %	CO <sub>2</sub> %/CO %	HCl (ppm)	H <sub>2</sub> S (%)	CH <sub>4</sub> ppm	NH <sub>3</sub> ppm
Effective path length	<b>Probes:</b> 200, 400, 800 mm (7.87", 15.75", 15.75", 31.50"). <b>Wafer Cell:</b> 104 mm, 110 mm, 154 mm, 164 mm, 214 mm (4.09", 4.33", 6.06", 6.46", 8.43") <b>Extractive cells:</b> 200 mm, 400 mm, 800 mm, 1 m, 8 m (7.87", 15.75", 31.50", 39.37", 315")					
Measurement range and standard conditions <sup>1)</sup>	0–2% (CO) 0–10% (CH <sub>4</sub> )	0–100% (CO <sub>2</sub> and CO)	0–3%	0–50%	0–1%	0–1%
Lower Detection Limit <sup>2)</sup>	1 ppm-v (CO) 100 ppm-v (CH <sub>4</sub> )	1000 ppm-v (CO <sub>2</sub> ) 1500 ppm-v (CO)	0.6 ppm-v	20 ppm-v	1 ppm-v	1 ppm-v
Accuracy	2% of reading or 1 ppm (CO) / 100 ppm-v (CH <sub>4</sub> ), whichever is greater	2% of reading or 1000 ppm, whichever is greater	2% of reading or 0.6 ppm, whichever is greater	2% of reading or 20 ppm, whichever is greater	2 % or 1 ppm	2 % or 1 ppm
Linearity	Better than 1%	Better than 1%	Better than 1%	Better than 1%	Better than 1%	Better than 1%
Resolution	1 ppm-v (CO) 100 ppm-v (CH <sub>4</sub> )	1000 ppm-v	0.6 ppm-v	20 ppm-v	1 ppm	1 ppm
Drift	Negligible (<2% of measurement range between maintenance intervals)					
Sampling rate	1 second	1 second	1 second	1 second	1 second	1 second
Response time (T90)	CO/CH <sub>4</sub> in N <sub>2</sub> 2% to 0% in <4 sec	CO <sub>2</sub> in N <sub>2</sub> 1% to 0% in <4 sec	HCl in N <sub>2</sub> 1% to 0% in <4 sec	H <sub>2</sub> S in N <sub>2</sub> 1% to 0% in <4 sec	CH <sub>4</sub> in N <sub>2</sub> 1% to 0% in <4 sec	NH <sub>3</sub> in N <sub>2</sub> 1% to 0% in <4 sec
Warm-up time	Typically <1 hour	Typically <1 hour	Typically <1 hour	Typically <1 hour	Typically <1 hour	Typically <1 hour
Repeatability	±0.25% of reading or 5 ppm-v CO/500 ppm-v CH <sub>4</sub> , whichever is greater	±0.25% of reading or 5000 ppm-v CO <sub>2</sub> or CO, whichever is greater	±0.25% of reading or 3 ppm-v HCl, whichever is greater	±0.25% of reading or 100 ppm-v H <sub>2</sub> S, whichever is greater	±0.25% of reading or 5 ppm-v CH <sub>4</sub> , whichever is greater	±0.25% of reading or 5 ppm-v NH <sub>3</sub> , whichever is greater
Process pressure range	0.8 bar to 2 bar (abs)/ 11.6 psi to 29 psi (abs)	0.8 bar to 2 bar (abs)/ 11.6 psi to 29 psi (abs)	0.8 bar to 3 bar (abs)/ 11.6 psi to 43.5 psi (abs)	0.8 bar to 2 bar (abs)/ 11.6 psi to 29 psi (abs)	0.8 bar to 3 bar (abs)/ 11.6 psi to 43.5 psi (abs)	0.8 bar to 3 bar (abs)/ 11.6 psi to 43.5 psi (abs)
Process temperature range	0 to +250 °C (+32 to +482 °F) Optional (for probe installation). 0 to +600 °C (0 to +1112 °F) with built in thermal barrier. 0 to +150 °C (+32 to +302 °F) (White cell)					

<sup>1)</sup> Measurement range and standard conditions (ambient temperature and pressure, 1 m path length).

<sup>2)</sup> Lower Detection Limit (in 1 meter path length at ambient standard conditions, dry gas, no dust load, in N<sub>2</sub> background).

# Gas Analyzers

Measure Everywhere It Matters

## Variant Configurator

Gas Analyzer	GPro 500	A	T	A	O	P	B	K	S	O	2	O	P	D	1	X	S	_	_	/	A	X
30 027 126*, 30 538 717**	GPro 500	Y	Y	Y	Y	Y	Y	Y	Y	Y	Y	Y	Y	Y	Y	Y	Y	Y	Y	/	Y	Y
<b>Hazardous area approvals</b>																						
ATEX/IECEX Ex d		A	T																			
FM Class 1 Div 1		U	S																			
<b>Gases</b>																						
Oxygen				A	O																	
CO				C	O																	
H <sub>2</sub> O				H	O																	
H <sub>2</sub> O ppm				H	1																	
CO <sub>2</sub> %				C	2																	
CO %				C	1																	
CO % + CO <sub>2</sub> %				C	C																	
CO ppm + CH <sub>4</sub> %				C	M																	
H <sub>2</sub> S				S	1																	
HCl ppm				L	O																	
CH <sub>4</sub> ppm				M	O																	
NH <sub>3</sub> ppm				N	O																	
<b>Process interfaces</b>																						
Standard Probe purged (SP)									P													
Non-purged Filter Probe (NP)									F													
Non-purged Filter Probe with Blow-back (BP)									B													
Wafer (W)									W													
Extractive Cell (E)									E													
Cross-pipe Folded Path (C)									C													
<b>Process optics***</b>																						
Borosilicate									B													
Quartz									Q													
Sapphire									S													
Dual Window Borosilicate									C													
Dual Window Quartz									R													
Dual Window Sapphire									T													
<b>Process sealings***</b>																						
Kalrez® 6375									K													
Graphite									G													
Kalrez® (FDA grade) 6230									F													
Kalrez® 6380									S													
Kalrez® 0090									R													
PFA-coated FEP									P													
<b>Wetted materials***</b>																						
1.4404 (equivalent to 316L)										S	O											
Hastelloy C22										C	O											
<b>Optical path probes and extractive cell***</b>																						
200 mm (7.9")											2	O										
400 mm (15.7")											4	O										
800 mm (31.5")											8	O										
1 m (3.3 ft)											0	1										
2 m (6.6 ft)											0	2										
3 m (9.8 ft)											0	3										
4 m (13.1 ft)											0	4										

**Variant Configurator (continued)**

Gas Analyzer	GPro 500	A	T	A	O	P	B	K	S	O	2	O	P	D	1	X	S	_	_	/	A	X			
30 027 126*, 30 538 717**	GPro 500	Y	Y	Y	Y	Y	Y	Y	Y	Y	Y	Y	Y	Y	Y	Y	Y	Y	Y	/	Y	Y			
5 m (16.4 ft)												0	5												
6 m (19.7 ft)												0	6												
10 m (32.8 ft)												1	0												
None												X	X												
<b>Process connections***</b>																									
DN 50/PN 25																					P	D			
ANSI 2"/300 lbs																						P	A		
DN 50/PN 16																						L	D		
ANSI 2"/150 lbs																						L	A		
DN 80/PN 16																						G	D		
ANSI 3"/150 lbs																						G	A		
DN 100/PN 25																						N	D		
ANSI 4"/300 lbs																						N	A		
ANSI 4"/150 lbs																						M	A		
DN 50/PN 16 and 40																						W	1		
DN 80/PN 16 and 40																						W	2		
DN 100/PN 16																						W	3		
ANSI 2"/150 lbs																						W	4		
ANSI 3"/150 lbs																						W	5		
ANSI 4"/150 lbs																						W	6		
Swagelok 6 mm																						E	M		
Swagelok 1/4"																						E	I		
<b>Wall thickness***</b>																									
100 mm																						1			
200 mm																						2			
300 mm																						3			
None																						X			
<b>Filters***</b>																									
Filter A – 40 µm																						A			
Filter B – 100 µm																						B			
Filter C – 200 µm																						C			
Filter D – 3 µm																						D			
Filter PTFE Membrane																						E			
No Filter																						X			
<b>Add-on modules***</b>																									
None																						X	_	_	/
With Thermal Barrier (up to 600 °C)																						H	_	_	/
2-fold Multireflection Cell																						2	_	_	/
3-fold Multireflection Cell																						3	_	_	/
<b>Cable</b>																									
5 m (16.4 ft)																								A	
15 m (49.2 ft)																								B	
25 m (82.0 ft)																								C	
40 m (131.2 ft)																								D	
None																								X	
<b>Communication interfaces</b>																									
RS485 (for M400)																								X	
RS485 and Direct Analog (SIL)																								A	

\* 6 weeks delivery time. \*\* 3 weeks delivery time. \*\*\* Other configurations upon request.

## InPro 6000 G Sensor Series

### Oxygen Control for Your Gas Applications



#### Features Overview

- True in-line measurement without gas sampling system
- Long lasting and easy to maintain membranes
- Certified for hazardous gaseous and dust areas
- Oxygen measurement is not affected by water, water vapors or most organic solvents

#### Other Highlights

- Membrane covered amperometric measurement technology allows direct in-line installations
- Sensor can easily be calibrated in air. Costly calibration gases are eliminated

The InPro 6000 G O<sub>2</sub> sensor series for gas measurement provides high operational availability together with excellent measurement performance. Without the need for expensive gas sample conditioning, the sensor can be installed directly in the process, and sensor maintenance or replacement can be performed without process interruption. METTLER TOLEDO offers a unique easy-to-use and reliable solution for challenging applications like N<sub>2</sub> blanketing, inertization and off-gas monitoring in Ex or non-Ex applications.

#### Specifications

##### Performance

Operating range	InPro 6800G/6850iG:	0.1 Vol-% O <sub>2</sub> to 100 Vol-% O <sub>2</sub>
	InPro 6900iG:	50 ppm to 60 Vol-% O <sub>2</sub>
	InPro 6950iG:	5 ppm to 50,000 ppm
Accuracy	InPro 6800G/6850iG:	≤ ± [1 % + 0.1 Vol-%]
	InPro 6900iG:	≤ ± [1 % + 50 ppm]
	InPro 6950iG:	≤ ± [1 % + 5 ppm]
Response time at 25 °C (77 °F) (N <sub>2</sub> → 15 Vol-% O <sub>2</sub> )		90 % of the signal in < 20
Sensor signal in air at 25 °C (77 °F)	InPro 6800G/6850iG:	50 to 110 nA
	InPro 6900iG:	250 to 500 nA
	InPro 6950iG:	2500 to 6000 nA

##### Construction

Measuring principle	Amperometric Clark electrode
Cable connection	Analog VarioPin (IP68), Digital K8S (IP68)
Connector design	Straight
Process connection	Pg 13.5
Sensor diameter	12 mm
Sensor body	316L stainless steel C22 (titanium on request)
Membrane material	PTFE/Silicone (reinforced with steel mesh)
Surface roughness of wetted parts	N5/R <sub>a</sub> 16 (R <sub>a</sub> = 0.4 µm / 16 µin)
O-ring material	Silicone or Kalrez®

##### Working Conditions

Temperature compensation	Automatic
Measuring temperature range	0 to 70 °C (32 to 158 °F)
Environmental temperature range	-5 to 121 °C (23 to 249.8 °F)
Operating pressure	0.2 to 9 bar (2.9 to 130 psi absolute)
Design pressure	Maximum 12 bar (174 psi absolute)

##### Certificates and Approvals

METTLER TOLEDO Quality Certificate, EHEDG, FDA/USP Class VI, 3.1, N5/R<sub>a</sub>16,  
 ATEX: Ex ia IIC T6/T5/T4/T3 Ga/Gb,  
 Ex ia IIIC T69 °C/T81 °C/T109 °C/T161 °C Da/Db  
 FM: IS Cl. I, II, III, Div 1, GR ABCDEFG/T6\*

##### Intelligent Sensor Management (ISM)

InPro 6000iG sensors with integrated ISM functionality allow Plug and Measure and advanced diagnostics. ISM simplifies the installation, handling and maintenance of measurement equipment. For more information see ISM introduction pages 10–11.

► [www.mt.com/O2-gas](http://www.mt.com/O2-gas)

**Ordering Information**

12 mm InPro 6800G Oxygen Sensors	Length	Connector Style	Order Number
InPro 6800G/12/120	120 mm	Straight VP	52 206 425
InPro 6800G/12/220	220 mm	Straight VP	52 206 426
InPro 6800G/12/120/Ka	120 mm	Straight VP	52 206 427
InPro 6800G/12/220/Ka	220 mm	Straight VP	52 206 428
InPro 6800G/12/120/C22	120 mm	Straight VP	52 206 429
InPro 6800G/12/220/C22	220 mm	Straight VP	52 206 430
12 mm InPro 6850 iG Oxygen Sensors			
InPro 6850iG/12/120	120 mm	Straight K8S	52 206 431
InPro 6850iG/12/220	220 mm	Straight K8S	52 206 432
InPro 6850iG/12/120/Ka	120 mm	Straight K8S	52 206 433
InPro 6850iG/12/220/Ka	220 mm	Straight K8S	52 206 434
InPro 6850iG/12/120/C22	120 mm	Straight K8S	52 206 435
InPro 6850iG/12/220/C22	220 mm	Straight K8S	52 206 436
12 mm InPro 6900 iG Oxygen Sensors			
InPro 6900iG/12/120	120 mm	Straight K8S	52 206 437
InPro 6900iG/12/220	220 mm	Straight K8S	52 206 438
InPro 6900iG/12/120/Ka	120 mm	Straight K8S	52 206 439
InPro 6900iG/12/220/Ka	220 mm	Straight K8S	52 206 440
12 mm InPro 6950 iG Oxygen Sensors			
InPro 6950iG/12/120	120 mm	Straight K8S	52 206 443
InPro 6950iG/12/220	220 mm	Straight K8S	52 206 444

**Consumables**

Designation	Order Numbers			
	InPro 6800G	InPro 6850 iG	InPro 6900 iG	InPro 6950 iG
Membrane body, single T-Type	52 201 151	52 206 453	52 206 459	52 206 465
Membrane body, single T-Type Ka (Kalrez® O-ring)	52 201 158	52 206 455	52 206 461	–
Membrane body, single T-Type C22 (Kalrez® O-ring, wetted part C22)	52 201 163	52 206 457	–	–
Membrane kit T-Type*	52 201 149	52 206 454	52 206 460	52 206 466
Membrane kit T-Type Ka**	52 201 159	52 206 456	52 206 462	–
Membrane kit T-Type C22***	52 201 164	52 206 458	–	–
Replacement anode/cathode assembly	52 206 449	52 206 450	52 206 451	52 206 452
O <sub>2</sub> electrolyte pack (3 × 25 ml)	30 298 424	30 298 424	–	–
InPro 6900 electrolyte pack (3 × 5 ml)	–	–	30 298 425	–
InPro 6950 electrolyte pack (3 × 5 ml)	–	–	–	30 298 426

\* 4 membranes, 1 O-ring set silicone, 25 ml electrolyte, wetted parts SS 316L  
 \*\* 4 membrane, 1 O-ring set Kalrez®, 25 ml electrolyte, wetted parts SS 316L  
 \*\*\* 4 membranes, 1 O-ring set Kalrez®, 25 ml electrolyte, wetted parts C22 (Hastelloy)

**Accessories**

Designation	Order Number
O <sub>2</sub> Sensor Master digital ISM	52 206 329
InPro 6800 Sensor Master	52 200 892

**Did You Know**  
 The InPro 6000G with ISM series feature a built-in electrolyte level monitor that signals the user when refilling is required.

O<sub>2</sub> sensor master



Replacement anode/cathode assembly of InPro 6950 iG



Membrane Body InPro 6800G



Membrane Body InPro 6850 iG

**Suitable Housings**

InFit 761 e.....	110
InFlow .....	114
InTrac 777 e.....	119
InTrac 797 e.....	120
InTrac 781 .....	121







# Process Analytics Measurement Solutions for Industrial and Pure Water Applications

# Conductivity/Resistivity Systems

## When Optimal Performance Is Essential

**Electrolytic conductivity is a widely used analytical parameter for water purity analysis, monitoring of reverse osmosis, cleaning procedures, control of chemical processes, and in industrial wastewater.**

### Three commonly used techniques

Electrolytic conductivity is a measure of the total ionic content of a solution. There are three main methodologies to measure conductivity:

- 2-electrode sensors are for measurements in high purity water and relatively low conductivity ranges
- 4-electrode sensors are for mid to high ranges. They are more resistant to fouling than 2-electrode designs
- Inductive sensors cover mid to very high conductivity ranges, and are particularly resistant to fouling.

METTLER TOLEDO offers all three methodologies.

### 2-electrode sensor design

An AC voltage is applied across the two electrodes, and the resistance between them is measured. The built-in temperature sensor provides fast accurate measurement. The cell geometry and the high solution resistance allow for very accurate and precise conductivity determination.

Sensors are used for water conditioning and purification stages where they are capable of detecting minute levels of impurities in ultrapure water.

### 4-electrode sensor design

An AC voltage is applied across the two outside electrodes. The principle is to measure the voltage drop across the two inner electrodes. Therefore, polarization errors are eliminated. Since this technique measures potential drop, the measurement remains accurate. It permits easier in-line cleaning and it can be installed in smaller piping than inductive sensors.

These sensors are used for concentration measurement of acids, alkalis, and salt process streams.



58 031 404



58 031 242



58 031 423



58 031 201

## Application guide for conductivity sensors

**Thornton sensors**  
 NPT titanium 0.1 cm<sup>2</sup> sensors  
 Sanitary 316L SS 0.1 cm<sup>2</sup> sensors  
 NPT CPVC & PEEK 4-E sensors  
 Sanitary PEEK 4-E sensors

Where to use	NPT titanium 0.1 cm <sup>2</sup> sensors	Sanitary 316L SS 0.1 cm <sup>2</sup> sensors	NPT CPVC & PEEK 4-E sensors	Sanitary PEEK 4-E sensors
Pure and ultrapure water	•	•		
Sanitary		•		•
Water purification	•			
SIP		•		•
Industrial wastewater			•	
Medium/high conductivity			•	•
Aggressive chemicals			•	
Chemical applications			•	
Pharmaceutical water		•		
High conductivity			•	•
Chemical concentration			•	•

### UniCond® Conductivity/Resistivity Sensors with ISM

The UniCond conductivity/resistivity sensor advancement integrates the measuring circuit and the physical sensor into a single unit. UniCond conductivity/resistivity sensors provide exceptionally wide measurement ranges due to their advanced built-in measuring circuit. The on-board measuring circuit eliminates interference from lead wire resistance and capacitance. Only digital signals go back to the transmitter. The UniCond design mitigates the effects of polarization, enabling the upper range of the conductivity sensor to be greatly expanded. UniCond 2-electrode sensors provide the ability to accurately measure from ultrapure water to brackish water (up to 50,000 µS/cm) with a single integrated sensor, greatly simplifying water treatment instrumentation. UniCond 4-electrode sensors measure up to 1 S/cm.

### Inductive Sensors (see page 68, 76–77)

### Continuous conductivity monitoring of pharmaceutical waters

USP guideline <645> sets a standard for the quality assessment of USP waters based on measurement of the electrolytic conductivity. There is a 3-stage test in which stage 1 allows on-line, non-temperature compensated conductivity measurement. There are specific requirements for the sensors and transmitters (see table below). Thornton instruments fulfill all these and other pharmacopeia requirements. In addition, Thornton instruments provide USP and EP setpoints for convenience.

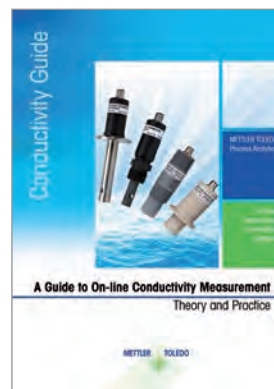

Find out more in our comprehensive conductivity theory guide at [www.mt.com/conductivity-guide](http://www.mt.com/conductivity-guide)

Specification	USP <645>
Conductivity sensor and cell constant accuracy	Verify cell constant within ± 2 % using a reference solution
Resistance measurement circuit	NIST traceable 0.1 % precision resistors in place of sensor
Instrument resolution	0.1 µS/cm
Instrument accuracy at 1.3 µS/cm	0.1 µS/cm
Temperature compensation	Must be read uncompensated
Instrument dynamic range	10 <sup>2</sup>

METTLER TOLEDO instruments meet USP <645> and other pharmacopeia water conductivity requirements

## UniCond Conductivity/Resistivity Sensors with ISM Certified Calibration for Compliance



UniCond conductivity/resistivity sensors provide exceptionally wide measurement ranges due to their advanced built-in measuring circuit. The on-board measuring circuit eliminates interference from leadwire resistance and capacitance. Only digital signals go back to the transmitter. Advanced measuring techniques further contribute to superior accuracy over the expanded range. ISM technology features pre-calibration Plug and Measure capabilities for fast, compliant start-up.

### Specifications

Accuracy	0.01 cm <sup>-1</sup> sensor: ± 1 %
	0.1 cm <sup>-1</sup> sensors: ± 1 % for 0.02 – 5,000 µS/cm; ± 3 % > 5,000 µS/cm
	4-E sensors: ± 4 %
Repeatability	± 0.25 %; ± 2 % for 4-E sensors
Temperature sensor	Pt 1000 RTD, IEC 60751, Class A, with NIST-traceable calibration
Temperature accuracy	± 0.1 °C at 25 °C; ± 0.5 °C for 4-E sensors
Maximum cable length	91 m (300 ft)
Finish (Sanitary 0.1 cm <sup>-1</sup> sensors)	Ra 0.2 micrometers (8 microinches), 316 L SS is electropolished
Insulator material	PEEK except for the CPVC sensors
Response time	90 % of value in < 5 s
Connector	IP 65, mates with 58 080 27X series cable

**ISM**®

### Features Overview

- Plug and Measure functionality
- Integral high-performance measuring circuit
- Robust digital output signal
- Calibration data stored internally
- Measuring circuit and system calibration can be performed in-line
- Simple compliance

### Other Highlights

- Extremely wide rangeability: ultrapure to sea water
- Highest accuracy
- NPT and Tri-Clamp connections



► [www.mt.com/UniCond](http://www.mt.com/UniCond)

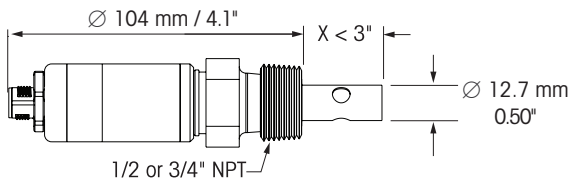

UniCond NPT 0.01 and 0.1 constant conductivity sensors

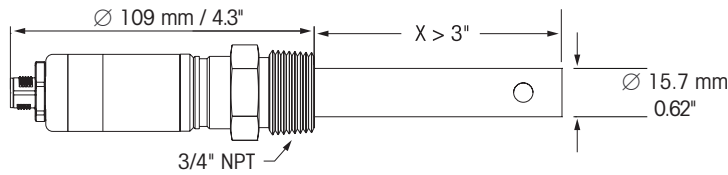

UniCond NPT 0.1 constant conductivity sensors

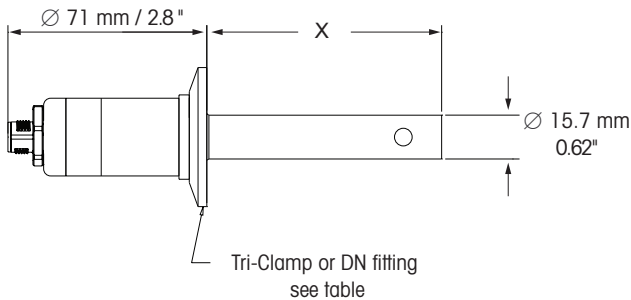

UniCond sanitary 0.1 constant conductivity sensor

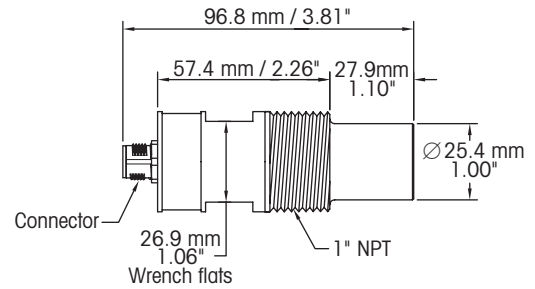

UniCond NPT PEEK conductivity sensors

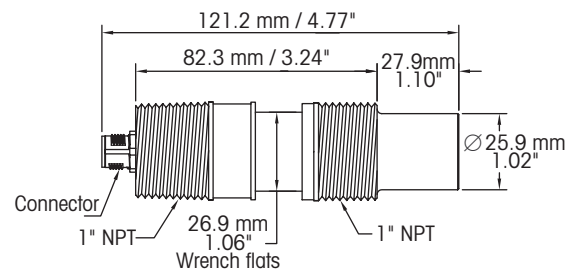

UniCond NPT CPVC conductivity sensors

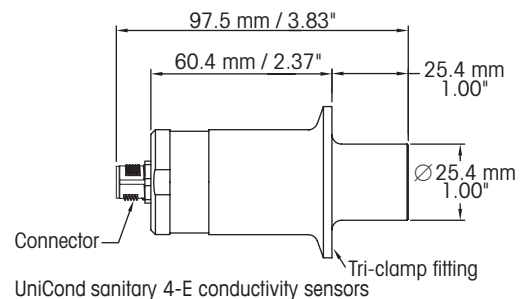

UniCond sanitary 4-E conductivity sensors

## Ordering Information

Description							Order Number
Fitting	Insertion Length "X" mm (inch)	Fitting/Body material	Range ( $\mu\text{S}/\text{cm}$ )*	Cell Const. ( $\text{cm}^{-1}$ )	Electrode Material	Max Pressure at Temp bar (psig) at °C (°F)	
3/4" NPTM	34 (1.35)	PTFE/SS	0.01–50,000	0.1	Titanium	17 (250) at 93 (200)	58 031 404
3/4" NPTM	132 (5.19)	PTFE/SS	0.01–50,000	0.1	Titanium	17 (250) at 93 (200)	58 031 409
3/4" NPTM	34 (1.35)	PTFE/SS	0.01–50,000	0.1	Monel	17 (250) at 93 (200)	58 031 407
3/4" NPTM	132 (5.19)	PTFE/SS	0.01–50,000	0.1	Monel	17 (250) at 93 (200)	58 031 408
1/2" NPTM	29 (1.14)	PTFE/SS	0.01–50,000	0.1	Titanium	17 (250) at 93 (200)	58 031 406
3/4" NPT	60 (2.38)	PTFE/SS	0.001–500	0.01	Titanium	17 (250) at 93 (200)	58 031 410
1 1/2" Tri-Clamp	86 (3.38)	Titanium	0.01–50,000	0.1	Titanium		58 031 413†
DIN/DN25	60 (2.38)	316L SS	0.01–3,000	0.1	316L SS		58 031 416†
ISO-DN25	60 (2.38)	316L SS	0.01–3,000	0.1	316L SS		58 031 417†
1 1/2" Tri-Clamp	55 (2.17)	316L SS	0.01–3,000	0.1	316L SS	14 (203) at 130 (266)	58 031 412†
1 1/2" Tri-Clamp	86 (3.38)	316L SS	0.01–3,000	0.1	316L SS	& 31 (450) at 25 (77)	58 031 414†
2" Tri-Clamp	105 (4.13)	316L SS	0.01–3,000	0.1	316L SS		58 031 415†
1" NPTM	28 (1.1)	PEEK	10–1,000,000	4-E	Hastelloy	7 (100) at 93 (200)	58 031 421
						14 (200) at 25 (77)	
1" NPTM	28 (1.1)	CPVC	10–1,000,000	4-E	316L SS	3.5 (50) at 80 (176)	58 031 422
1" NPTM	28 (1.1)	CPVC	10–1,000,000	4-E	Hastelloy	7 (100) at 25 (77)	58 031 423
1 1/2" Tri-Clamp	25 (1.0)	PEEK	10–1,000,000	4-E	316L SS		58 031 424†
2" Tri-Clamp	25 (1.0)	PEEK	10–1,000,000	4-E	316L SS	4.8 (70) at 140 (284)	58 031 425†
1 1/2" Tri-Clamp	25 (1.0)	PEEK	10–1,000,000	4-E	Hastelloy	14 (200) at 50 (122)	58 031 426†

\* Megohm-cm = 1/ $\mu\text{S}/\text{cm}$

† FDA compliant materials with certification to meet EN10204 3.1 & USP <88> Class VI

## DCC1000e System with ISM

### Precise Detection of Corrosive Contaminants



**ISM<sup>®</sup>**

The METTLER TOLEDO Thornton DCC1000e System offers a new streamlined design for conductivity measurement of power cycle chemistry monitoring. By providing measurements in compliance with ASTM D4519 combined with digital sensor technology, this system provides assurance of water purity to maximize power production and minimize corrosion.

**Features / Benefits:**

- Precise detection of corrosive contaminants through digital sensor technology: Faster plant start-ups and simpler turbine warranty compliance
- Multi-parameter M800 transmitter with single-screen display of all measurements with touchscreen simplicity: Easy parameter display, monitoring and control in one transmitter
- Integrated turbine flow sensor: For precision control of system flow and system safety with auto shutoff
- Resin column monitoring of deionization capacity: Provides direct information of resin column health through our unique DI-Cap™ feature

**Typical Applications**

- Feed water and steam monitoring during plant startups to decide how quickly to bring the turbine online.
- Power steam quality monitoring to ensure turbine warranty conditions are met.
- Power condensate monitoring to help differentiate between air in-leakage and cooling water leaks.

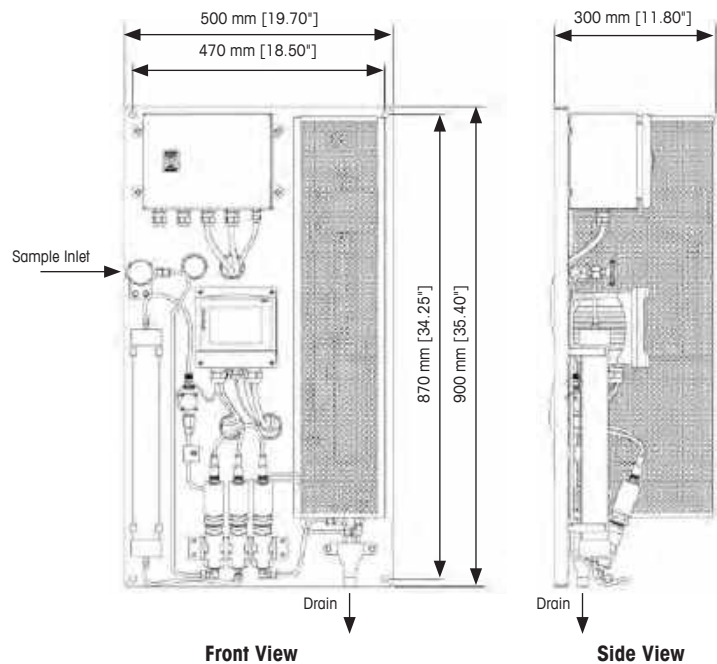

► [www.mt.com/DCC1000e](http://www.mt.com/DCC1000e)

## System Specifications

Power supply	100 – 140 VAC and 200 – 240 VAC, 1600 W typical
AC frequency	50 to 60 Hz
Sample flow rate	150 – 350 mL/min
Sample temperature	20–60 °C (68–140 °F)*
Sample pressure	0.3–4 bar (5–58 psig)
Cation resin	600 cm <sup>3</sup>
Ambient operating temperature	5–50 °C (41 – 122 °F)
Humidity	10–90% non-condensing
Dimensions (HxWxD)	900 × 500 × 300 mm (35.4 × 19.7 × 11.8")
Weight	29 kg (63.9 lb)
Rating / approvals	CE

\* Option for external cooling for temperatures above 60 °C

### Sensor: UniCond with ISM

Accuracy	± 1%
Repeatability	± 0.25%
Temperature sensor	Pt 1000 RTD, IEC 60751, Class A, with NIST-traceable calibration
Temperature accuracy	± 0.1 °C at 25 °C
Wetted materials	Titanium, PEEK
Response time	90% of value in < 3 s
Signal to transmitter	Digital (modified RS485)

### Transmitter: Multi-parameter M800 with ISM

Current (analog) outputs	8 × 0/4 to 20 mA, 22 mA alarm, galvanically isolated from input and from earth/ground
Analog output accuracy	± 0.05 mA over 1 to 20 mA range
Analog output configuration	Linear, Bi-linear, Logarithmic, Autoranging
Analog output load	500 Ω max.
Digital communication	USB, Type B connector
User interface	Color touchscreen 5.7" Resolution 320 × 240 px 256 colors
Update time (meas. update rate)	1 per second
Hold input	Selectable
Alarm control delay	Selectable, 0 to 999 s
Connection terminal	Spring cage terminals appropriate for AWG 16 – 24 / 0.2 mm <sup>2</sup> wires
Relays	4-SPST mechanical rated at 250 VAC, 3 Amps (Relay 1 NC, Relay 2 to 4 NO); 4-SPST Type Reed 250 VAC or DC, 0.5 Amps (Relay 5 to 8)
Digital input	6 with switching limits 0.00 VDC to 1.00 VDC for low level 2.30 VDC to 30.00 VDC for high level
Main fuse	2.0 A slow blow type FC, not replaceable

## Ordering Information

Description	Order Number
DCC1000e System, 100 – 140 VAC	30 421 478
DCC1000e System, 200 – 240 VAC	30 421 480
DCC1000e System with separate cooling input ports, 100 – 140 VAC	30 421 479
DCC1000e System with separate cooling input ports, 200 – 240 VAC	30 421 481

## Analog Conductivity Sensors A Comprehensive Series to Meet Industry Requirements



METTLER TOLEDO Thornton provides a full complement of analog conductivity/resistivity sensors with NPT or sanitary fittings. They include various lengths, cell constants and materials to match the application: titanium concentric electrodes for high purity water; monel electrodes for rinse waters containing HF; highly polished 316 L stainless steel (SS) electrodes for pharmaceutical waters; CPVC and PEEK sensors with four flush electrodes for solutions with higher conductivity and/or suspended material.

### Specifications

Cell constant accuracy	± 1 %, except ± 5 % system accuracy for 4-electrode & 10 constant
Cell constant repeatability	± 0.25 %, except ± 2 % for 4-electrode & 10 constant
Temperature sensor	Pt 1000 RTD, IEC 60751, Class A
Temperature accuracy	± 0.1 °C (± 0.2 °F) at 25 °C (77 °F), except ± 0.5 °C (± 0.9 °F) for 4-electrode sensors
Cable jacket material	NPT: PVC, 80 °C (176 °F) rating Sanitary: PTFE, 200 °C (392 °F) rating
Max. sensor distance	60 m (200 ft), except 15 m (50 ft) for 244-Series
Finish, sanitary 0.1 cm <sup>-1</sup> sensors	R <sub>a</sub> < 0.2 μm / R <sub>a</sub> < 8 μin, 316L SS is electropolished
Insulator material	PEEK (0.01 & 0.1 constant); Noryl (10 constant)

### Features Overview

- Precise factory calibration and certification of each cell constant and RTD
- Optimized 4-wire measuring circuitry provides exceptional rangeability and accuracy, eliminating cable effects
- Quick and easy installation

### Typical Applications

- Pharmaceutical water
- Power and steam generation
- Semiconductor water treatment
- Recycle and reclaim water
- Wastewater treatment

### For detailed information about conductivity sensors for M300:

Please refer to pages 160–161 for ordering information and drawings



### Sensor Selection Criteria

- Thornton offers a wide variety of conductivity/resistivity sensors to accommodate most applications. Use the following criteria to select the appropriate sensor for your installation:
- Conductivity or resistivity range
  - Transmitter
  - Mounting type: insertion, retractable or submersion
  - Pipe connection and size
  - Chemical compatibility, including cleaning and disinfection processes
  - Temperature requirements, including steam and/or hot chemical cleaning

► [www.mt.com/Thornton-Cond](http://www.mt.com/Thornton-Cond)



## Calibration of Conductivity Sensors



### Thornton Auto-loop Factory Calibration System

Thornton conductivity sensors are industry standards for determining water purity and solution concentration. Thornton ISO 9001 factory calibration and certification are NIST and ASTM traceable using Thornton's unique ultrapure auto-loop calibration system. Certification includes test and accuracy, plus materials as noted in sensor specifications.

USP pharmaceutical water monitoring requirements are met with sanitary sensors which provide accurate conductivity and temperature measurement. 316L stainless steel Tri-Clamp mounting sensors have an electropolished finish with roughness average ( $R_a$ )  $< 0.2 \mu\text{m}$ ,  $< 8 \mu\text{in}$ .

4-electrode sensors are ideal for monitoring high conductivity applications, clean-in-place (CIP) solutions and deionizer regenerant concentrations.



### Did You Know

Thornton conductivity systems are routinely used by other instrument suppliers as the reference to provide traceability when calibrating their instrumentation.



### Conductivity Standard Solutions

Provided for sensor verification and recalibration, conductivity standards are produced, analyzed and documented in the METTLER TOLEDO Thornton ISO 9001 certified facility with processes similar to those used to calibrate high accuracy Thornton conductivity sensors. They are provided with label and certificate with lot number, certified value, expiration date, plus ASTM and NIST traceability data. These standards are analyzed and used at equilibrium with the atmosphere.

### Specifications

Standard	Accuracy	Shelf Life	Order Number
25 $\mu\text{S/cm}$ , 500ml, HCl	$\pm 3\%$	6 months	58 078 001
100 $\mu\text{S/cm}$ , 500ml, KCl	$\pm 1\%$	12 months	58 078 002
1,000 $\mu\text{S/cm}$ , 500ml, KCl	$\pm 1\%$	12 months	58 078 003
10,000 $\mu\text{S/cm}$ , 500ml, KCl	$\pm 1\%$	12 months	58 078 004
100,000 $\mu\text{S/cm}$ , 500ml, KCl	$\pm 1\%$	12 months	58 078 005

# Conductivity/Resistivity Sensors

Accurate and Reliable

## Analog Conductivity Sensors

### Drawings

#### NPT 0.01 and 0.1 Constant

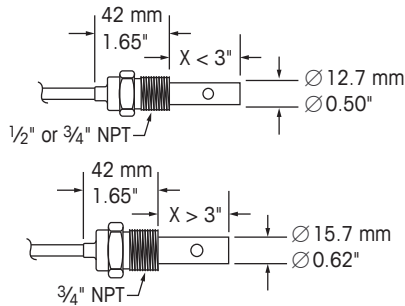

#### Sanitary, Standard

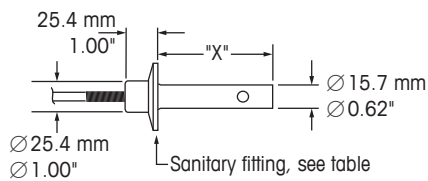

#### Sanitary, VP

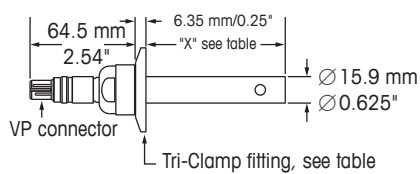

#### 316SS Flow Housing (58 084 000)

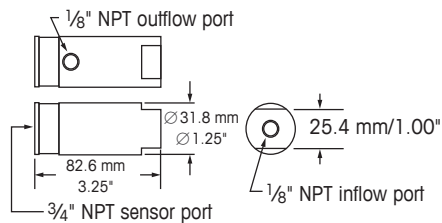

#### PVDF Flow Housing (58 084 001)

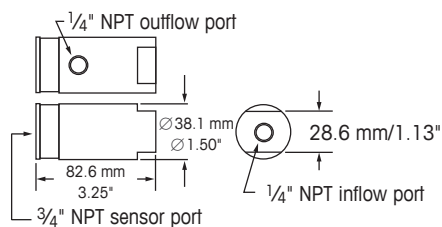

#### 316SS Flow Housing (58 084 016)

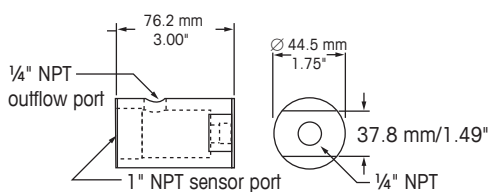

#### 10 Constant (58 031 241)

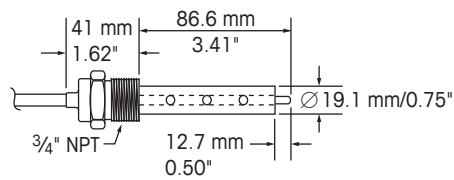

#### Submersion 0.1 Constant (58 031 207)

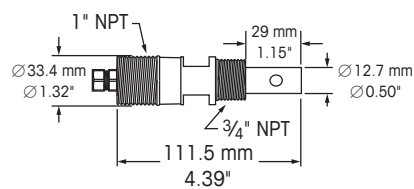

#### NPT 4-Electrode, CVPC

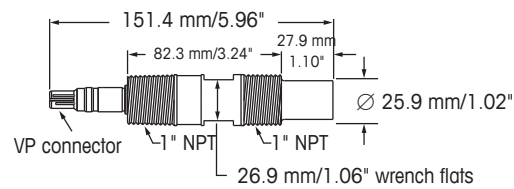

#### NPT 4-Electrode, PEEK

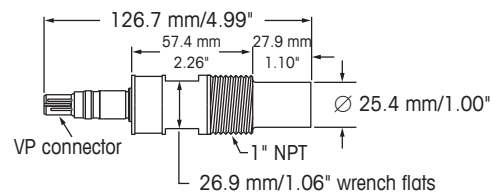

#### Sanitary 4-Electrode

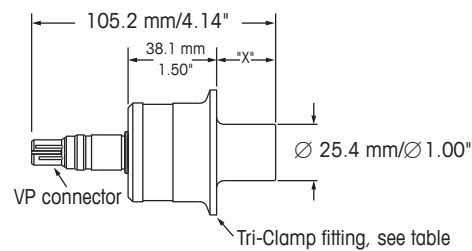

#### Boiler Water Conductivity Sensor

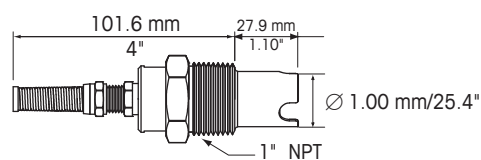

## Ordering Information

Electrode Material	Maximum Pressure	Process Connection		Insertion Length "x"	Cable			Order Number
		- Fitting	- Material		Length	Connector		
<b>2-Electrode Sensors</b>								
<b>- Measuring range 0.02–2,000 µS/cm (cell constant 0.1 cm<sup>-1</sup>)<sup>a</sup></b>								
Titanium	17 bar(g) at 93 °C (250 psig at 200 °F)	¾" NPTM	PTFE/SS	34 mm (1.35")	0.5 m (1.5 ft)	S		58 031 201
Titanium	17 bar(g) at 93 °C (250 psig at 200 °F)	¾" NPTM	PTFE/SS	132 mm (5.19")	0.5 m (1.5 ft)	S		58 031 202
Monel	17 bar(g) at 93 °C (250 psig at 200 °F)	¾" NPTM	PTFE/SS	34 mm (1.35")	0.5 m (1.5 ft)	S		58 031 203
Monel	17 bar(g) at 93 °C (250 psig at 200 °F)	¾" NPTM	PTFE/SS	132 mm (5.19")	0.5 m (1.5 ft)	S		58 031 204
316L SS	4 bar(g) at 131 °C (58 psig at 268 °F) 7 bar(g) at 95 °C (100 psig at 203 °F) 17 bar(g) at 25 °C (250 psig at 77 °F)	For Retractable housing <sup>b</sup>	SS	70 mm (2.75")	–	VP		52 001 998
Titanium	17 bar(g) at 93 °C (250 psig at 200 °F)	½" NPTM	Noryl	29 mm (1.14")	0.5 m (1.5 ft)	S		58 031 213
Titanium	17 bar(g) at 93 °C (250 psig at 200 °F)	¾" NPTM	Noryl	29 mm (1.14")	0.5 m (1.5 ft)	S		58 031 214
Titanium	17 bar(g) at 93 °C (250 psig at 200 °F)	¾" NPTM	PTFE/SS	34 mm (1.35")	3 m (10 ft)	S		58 031 215
Titanium	17 bar(g) at 93 °C (250 psig at 200 °F)	½" NPTM	PTFE/SS	29 mm (1.14")	0.5 m (1.5 ft)	S		58 031 216
Titanium	17 bar(g) at 93 °C (250 psig at 200 °F)	¾" NPTM	PTFE/SS	34 mm (1.35")	6.1 m (20 ft) <sup>c</sup>			58 031 217
Titanium	17 bar(g) at 93 °C (250 psig at 200 °F)	½" NPTM	PTFE/SS	29 mm (1.14")	3 m (10 ft) <sup>c</sup>			58 031 218
Titanium	17 bar(g) at 93 °C (250 psig at 200 °F)	¾" NPTM	PTFE/SS	34 mm (1.35")	9 m (30 ft) <sup>c</sup>			58 031 220
Titanium	10 bar(g) at 155 °C (150 psig at 311 °F) 31 bar(g) at 25 °C (450 psig at 77 °F)	1.5" Tri-Clamp	Titanium	86 mm (3.38")	0.5 m (1.5 ft)	S		58 031 221 <sup>d</sup>
316L SS	10 bar(g) at 155 °C (150 psig at 311 °F) 31 bar(g) at 25 °C (450 psig at 77 °F)	1.5" Tri-Clamp	316L SS	86 mm (3.38")	0.5 m (1.5 ft)	S		58 031 223 <sup>d</sup>
316L SS	10 bar(g) at 155 °C (150 psig at 311 °F) 31 bar(g) at 25 °C (450 psig at 77 °F)	2" Tri-Clamp	316L SS	105 mm (4.13")	0.5 m (1.5 ft)	S		58 031227 <sup>d</sup>
Titanium	17 bar(g) at 93 °C (250 psig at 200 °F)	¾" NPTM	PTFE/SS	34 mm (1.35")	0.5 m (1.5 ft)	VP		58 031 232
Titanium	17 bar(g) at 93 °C (250 psig at 200 °F)	¾" NPTM	PTFE/SS	132 mm (5.19")	0.5 m (1.5 ft)	VP		58 031 233
316L SS	10 bar(g) at 155 °C (150 psig at 311 °F) 31 bar(g) at 25 °C (450 psig at 77 °F)	1.5" Tri-Clamp	316L SS	55 mm (2.17")	–	VP		58 031 226 <sup>d</sup>
316L SS	10 bar(g) at 155 °C (150 psig at 311 °F) 31 bar(g) at 25 °C (450 psig at 77 °F)	1.5" Tri-Clamp	316L SS	85 mm (3.35")	–	VP		58 031 234 <sup>d</sup>
316L SS	10 bar(g) at 155 °C (150 psig at 311 °F) 31 bar(g) at 25 °C (450 psig at 77 °F)	2" Tri-Clamp	316L SS	104 mm (4.10")	–	VP		58 031 235 <sup>d</sup>
<b>- Measuring range 0.002–200 µS/cm (cell constant 0.01 cm<sup>-1</sup>)<sup>a</sup></b>								
Titanium	17 bar(g) at 93 °C (250 psig at 200 °F)	¾" NPTM	PTFE/SS	60 mm (2.38")	0.5 m (1.5 ft)	S		58 031 230
<b>- Measuring range 10–20,000 µS/cm (cell constant 0.4 cm<sup>-1</sup>)<sup>a</sup></b>								
316L SS	35 bar(g) at 25 °C (500 psig at 77 °F) 17 bar(g) at 200 °C (250 psig at 392 °F)	1" NPTM	316L SS	28 mm (1.10")	3 m (10 ft)	VP		58 031 264
<b>- Measuring range 50–40,000 µS/cm (cell constant 10 cm<sup>-1</sup>)<sup>a</sup></b>								
Graphite	17 bar(g) at 93 °C (250 psig at 200 °F)	¾" NPTM	PTFE/SS	86 mm (3.38")	0.5 m (1.5 ft)	S		58 031 241
<b>4-Electrode Sensors<sup>e</sup></b>								
<b>- Measuring range 10–650,000 µS/cm</b>								
316L SS <sup>d</sup>	5 bar(g) at 150 °C (70 psig at 302 °F) 14 bar(g) at 50 °C (200 psig at 122 °F)	1.5" Tri-Clamp	PEEK	25 mm (1.00")	–	VP		58 031 242
316L SS <sup>d</sup>	5 bar(g) at 150 °C (70 psig at 302 °F) 14 bar(g) at 50 °C (200 psig at 122 °F)	2" Tri-Clamp	PEEK	25 mm (1.00")	–	VP		58 031 243
Hastelloy C <sup>d</sup>	5 bar(g) at 150 °C (70 psig at 302 °F) 14 bar(g) at 50 °C (200 psig at 122 °F)	1.5" Tri-Clamp	PEEK	25 mm (1.00")	–	VP		58 031 245
316L SS <sup>d</sup>	5 bar(g) at 150 °C (70 psig at 302 °F) 14 bar(g) at 50 °C (200 psig at 122 °F)	1.5" Tri-Clamp	PEEK	12 mm (0.50")	–	VP		58 031 248
Hastelloy C	7 bar(g) at 93 °C (100 psig at 200 °F) 14 bar(g) at 25 °C (200 psig at 77 °F)	1" NPTM	PEEK	28 mm (1.10")	–	VP		58 031 239
316L SS	3.5 bar(g) at 80 °C (50 psig at 176 °F) 7 bar(g) at 25 °C (100 psig at 77 °F)	1" NPTM	CPVC	28 mm (1.10")	–	VP		58 031 240
Hastelloy C	3.5 bar(g) at 80 °C (50 psig at 176 °F) 7 bar(g) at 25 °C (100 psig at 77 °F)	1" NPTM	CPVC	28 mm (1.10")	–	VP		58 031 244

<sup>a</sup> MΩ × cm = 1 / (µS/cm)

<sup>b</sup> See pages 170–171 for retractable housing (also used for pH and ORP)

<sup>c</sup> Tinned leads – no patch cord required

<sup>d</sup> Includes material certification to meet EN 10204 3.1 & USP<88> ClassVI

<sup>e</sup> 4-electrode sensor, maximum patch cord length 15 m (50 ft)

S = Standard connector used with 58 080 25X patch cords only.  
See page 209.

VP = VarioPin sealed connector used with 58 080 20X patch cords only  
(58 080 101 3-ft adapter cable can connect an existing 58 080 25 X  
patch cord to a VP sensor). See page 209.

# pH and ORP Systems

## Reliable in Pure Water Treatment Applications

**With many decades of experience in designing pH/ORP electrodes METTLER TOLEDO offers a state-of-the-art solution for practically any type of process analytical application.**

### Functional definition

pH can be described as a measurement of the relative acidity of a solution. Oxidation reduction potential (ORP) as measured with an ORP electrode, provides an indication of the oxidative state of the solution. It is important to measure, and often to control the pH and/or ORP of a solution for several reasons:

- To produce products with consistent well defined properties
- To efficiently produce products at optimal cost
- To avoid health risks

- To protect the environment
- To prevent physical/chemical damage to materials
- To meet regulatory requirements
- To expand scientific knowledge

The accurate measurement of pH/ORP is critical in most industries. Each application has unique physical requirements of chemical, temperature, and pressure resistance and possibly hygienic design. Another factor is what is to be done with the measurement: monitoring only, data logging or process control.

### pH electrode selection

It is important to understand the details of the application before selecting a pH electrode. The table on the next page gives an initial glance at the various electrodes available and typical applications. Selection of a pH electrode requires a thorough knowledge of the process. Once the requirements are known, comparison of the electrode specifications detailed in this catalog will identify the appropriate sensor.



InPro 3250 i/SG-120



pHure LE



4260 i/SG-120

**Thornton pH electrode selection guide  
by industry and application**

	ORP * Pt 4805 – DPA	Pt 4805 (high pressure) – Dxx pH	4010	3250(i)	4260(i)	4501	pHure Sensor	pHure Sensor LE
<b>Industrial processes</b>								
<b>Pharmaceutical Industry</b>								
Makeup water	•	•		•				
Wastewater				•	•	•		
<b>Power Industry</b>								
Makeup water	•	•		•			•	
Cycle chemistry	•			•			•	•
Stator cooling				•			•	•
Scrubber					•	•		
Wastewater				•	•	•		
<b>Semiconductor Industry</b>								
Makeup water	•	•		•			•	
Recycle, reclaim, waste			•	•	•	•		
<b>Water Treatment</b>								
Air scrubbers		•			•	•		
Cooling water		•	•	•	•	•		
Neutralization	•	•	•	•	•	•		
Potable water			•	•				
<b>Wastewater Treatment</b>								
Flue gas neutralization		•		•	•	•		
Galvanic wastewater	•	•		•	•	•		
Industrial wastewater		•			•	•		
Precipitation of heavy metals		•		•	•	•		
Sludge dewatering		•			•	•		

\* New pH/ORP sensors with ISM allow measurement of pH and ORP with the same sensor!

## pH/ORP Sensors with ISM Convenient Maintenance and Calibration



4260i/SG-120 3250i/SG-120

**ISM<sup>®</sup>**

4260i/SG-225  
For Retractable  
Housing

METTLER TOLEDO Thornton offers pH and ORP sensors designed specifically for water treatment. The inclusion of ISM technology allows Plug and Measure capabilities, easier maintenance and convenient calibration. A variety of housings ensure a wide range of installation requirements can be met. The solution ground feature enables ORP measurement and ISM sensor diagnostics, and prevents measurement errors due to ground potentials.

### Specifications

#### General

Measuring electrode	Glass pH, platinum ORP/solution ground
Reference electrode	Silver-silver chloride with double junction or equivalent
Temperature compensator	NTC included in all sensors
pH range	0–14 pH, except InPro 4010 which is 2–12 pH
Maximum flow	3 m/s (10 ft/s)
Max. cable lengths	80 m (262.4 ft)

For electrode ratings see table "Ordering Information" on the next page.

For housings see pages 170–171.

### Features Overview

- Convenient electrical and process connections for easy maintenance and calibration
- Advanced METTLER TOLEDO sensor technology for high performance and long life
- Integral temperature sensing for accurate measurement and compensation
- On-line pH sensor diagnostics for assurance of process surveillance

### Typical Applications

- Wastewater neutralization
- Pharmaceutical water treatment
- Power and steam generation cycle chemistry and scrubbers
- Semiconductor ultrapure water treatment

### Ordering Information

ISM Electrodes	Rating	Sensor Type	Electrode Conn.	Housing Conn.	Length	Order Number
<b>– For pH &amp; ORP, General Purpose, High Pressure Applications ISM</b>						
4260i-SG-120	See housing limits	Glass and Pt	K8S	Pg 13.5	120mm	52 005 381
<b>– For pH &amp; ORP, Retractable ISM</b>						
4260i-SG-225	See housing limits	Glass and Pt	K8S	Pg 13.5	225mm	52 005 382
<b>– For pH &amp; ORP, General Purpose &amp; Moderately Pure Water ISM</b>						
3250i-SG-120	0 to 100 °C (32 to 212 °F)	Glass and Pt	K8S	Pg 13.5	120mm	52 005 373
<b>– For pH, HF-Resistant Applications</b>						
4262i-SG-120	See housing limits	Glass	K8S	Pg 13.5	120mm	30 018 467

Analog Electrodes	Rating	Sensor Type	Electrode Conn.	Housing Conn.	Length	Order Number
<b>– For pH, General Purpose, Applications</b>						
4010-120-Pt1000	0 to 60 °C (32 to 140 °F) 2 bar(g)/60 °C (30 psig/140 °F) 5 bar(g)/45 °C (75 psig/113 °F)	Polysulfone and glass	VP	Pg 13.5	120mm	52 000 512
<b>– For pH, General Purpose, High Pressure Applications</b>						
4260-120-Pt1000	See housing limits	Glass	VP	Pg 13.5	120mm	52 002 987
<b>– For pH &amp; ORP, General Purpose &amp; Moderately Pure Water Applications *</b>						
3250SG-120-Pt1000	0 to 100 °C (32 to 212 °F) 4 bar(g) (60 psig)	Glass	VP	Pg 13.5	120mm	52 002 559
<b>– For pH, HF-Resistant Applications</b>						
4262-120-Pt1000-VP	See housing limits	Glass	VP	Pg 13.5	120mm	52 003 550
<b>– For pH, Retractable Applications</b>						
4260-225-Pt1000	See housing limits	Glass	VP	Pg 13.5 retractable	225mm	52 002 989

Accessories	Order Number
iSense full version	30 130 614
iSense lite version	Available for free
iSense mobile version	Available for free
iLink cable for iSense	52 300 383

\* For use with moderately pure waters (conductivity 5 to 50 µS/cm) use 53 300 021 housing in ¾" NPT(M) earth-grounded metal pipe tee with flow < 100 ml/min and discharge to open drain. For higher purity and/or higher accuracy in pure water see pHure Sensor, page 166–169.

\* All new installations require an electrode, housing and cable.

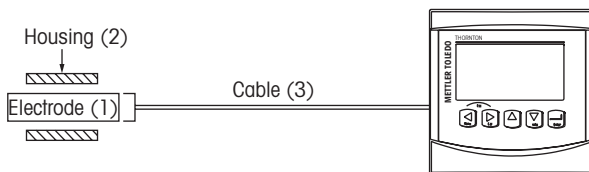

A complete pH or ORP installation requires an electrode (1), a housing (2) and a VP or AS9 cable (3). For suitable housings consult the table on page 170. For suitable cables see table pages 134–135 for analog or page 211 for ISM installations. Each installation requires a transmitter.

## pHure Sensor with ISM

### Reliable pH Measurement in Pure Waters



**ISM<sup>®</sup>**

The METTLER TOLEDO Thornton pHure Sensor<sup>®</sup> uses a special internally-pressurized gel electrolyte reference electrode to produce results similar to a flowing junction but with much more convenient installation and maintenance. The electrode also includes a low resistance pH glass membrane, an integral, fast-responding RTD, and AK9 connection. All components of the pHure Sensor have been optimized for performance and value and conform to ASTM Standard D5128. The inclusion of ISM technology allows Plug and Measure capabilities, easier maintenance and convenient calibration. Various lengths of cable can be selected to provide flexibility in locating the sensor.

#### Specifications

Wetted materials	pH Glass
Process connections	1/4" NPT(F) in/out
Flow housing volume	5 ml with electrode in place
Maximum pressure	Atmospheric pressure for optimum stability; operational 0 to 2.5 bar(g) (0 to 35 psig); can safely withstand 7 bar(g) (100 psig)
Sample temperature	0 to 80 °C (32 to 176 °F); short term to 100 °C (212 °F)
Sample pH	1 – 11 pH
Sample flowrate	50 to 150 ml/min
Sample conductivity	> 1.5 µS/cm for highest accuracy
Connection	AK9 or VP cable from sensor to instrument

#### Features Overview

- Pressurized gel electrolyte
- Accurate, fast responding temperature compensator
- Low resistance glass membrane
- Solution ground connection
- Low volume 316 stainless steel flow housing

#### Typical Applications

- Reverse osmosis – pH adjustment of clean recycle water or between membranes in two pass systems to optimize rejection rates
- Power plant cycle chemistry
- Monitoring and controlling pH levels to comply with guidelines and minimize corrosion and scaling



## Ordering Information

pHure Sensor		Order Number
pHure Sensor ISM combination electrode with temperature compensator		52 003 821
pHure Sensor combination electrode with RTD		52 002 447
* All new installations require a sensor, housing and cable.		
Housing		Order Number
Flow housing		58 084 010

Cables (pHure Sensor ISM combination electrode with temperature compensator)	
Cable length	AK9
1m (3.3 ft)	59 902 167
3m (9.8 ft)	59 902 193
5m (16.4 ft)	59 902 213
10m (32.8 ft)	59 902 230
20m (65.6 ft)	52 300 204
30m (98.4 ft)	52 300 393
50m (164.0 ft)	52 300 394
80m (262.4 ft)	52 300 395

Cables (pHure Sensor combination electrode with RTD)	
Cable length	VP
1m (3.3 ft)	52 300 107
3m (9.8ft)	52 300 108
5m (16.4 ft)	52 300 109
10m (32.8 ft)	52 300 110

Accessories		Order Number
iSense full version		30 130 614
iSense lite version		Available for free
iSense mobile version		Available for free
iLink cable for iSense		52 300 383

\* For pH and ORP buffers, refer to page 171.

pHure Sensor dimensions

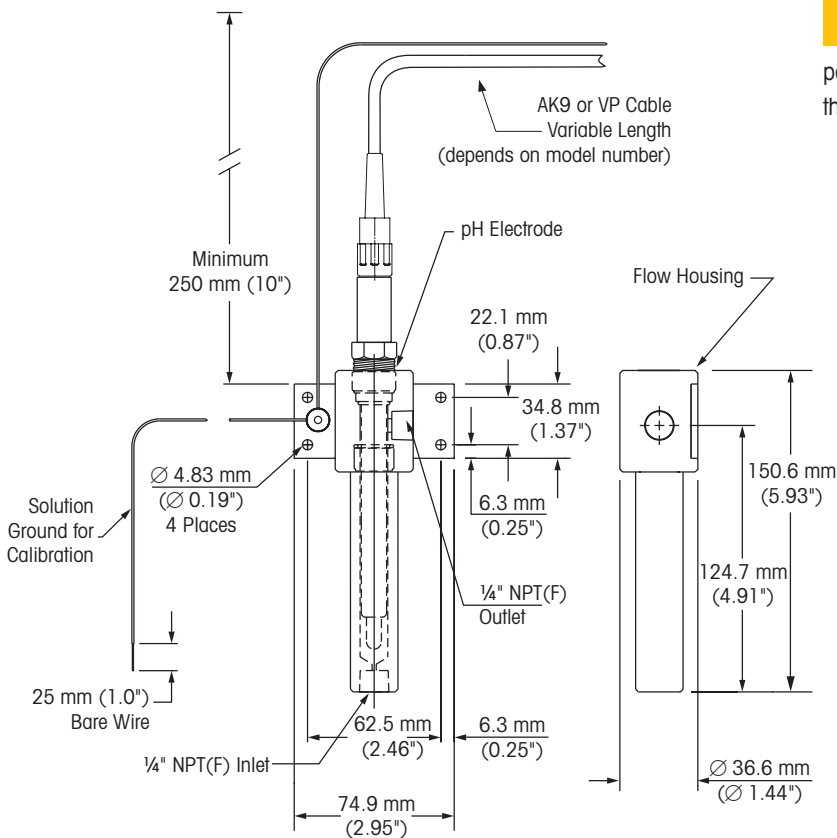

## Did You Know

The small volume and high sample velocity of the pHure Sensor ensures fast response by preventing power plant corrosion products from accumulating around the electrode membrane.

## pHure Sensor LE with ISM

### Reliable pH Measurement in Pure Waters



The METTLER TOLEDO Thornton pHure Sensor LE uses a free-flowing junction to provide the most accurate pH measurement available in low conductivity water. The electrode includes a special pH glass membrane, an integral, fast-responding temperature sensor, and VP or AK9 connection. All components of the pHure Sensor LE have been optimized for performance and value and conform to ASTM Standard D5128. The inclusion of ISM technology allows Plug and Measure capabilities, easier maintenance and convenient calibration. Various lengths of cable can be selected to provide flexibility in locating the sensor.

#### Specifications

Wetted materials	pH Glass, platinum solution ground/ORP
Process connections	1/4" NPT(F) in/out
Flow housing volume	5 ml with electrode in place
Maximum pressure	Atmospheric pressure for measurement; can safely withstand 7 bar(g) (100 psig)
Sample temperature	0 to 100 °C (32 to 212 °F)
Sample pH	1 – 12 pH
Sample flowrate	50 to 150 ml/min
Sample conductivity	> 0.3 μS/cm for highest accuracy
Connection	AK9 or VP cable from sensor to instrument
Reference electrode	3M KCl

#### Features Overview

- Free-flowing junction / diaphragm
- Simultaneous pH & ORP measurements
- Accurate, fast responding temperature compensator
- Low resistance glass membrane
- Low volume 316 stainless steel flow housing
- Easily refillable electrolyte chamber

#### Typical Applications

- Power plant cycle chemistry where pH measurement in low conductivity water is critical
- Reverse osmosis – pH adjustment of clean recycle water or between membranes in two pass systems to optimize rejection rates
- Monitoring and controlling pH levels to comply with guidelines and minimize corrosion and scaling

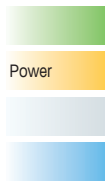

Power

### Ordering Information

pHure Sensor LE		Order Number
pHure Sensor LE ISM electrode		30 039 086
pHure Sensor LE analog electrode		30 039 085
* All new installations require a sensor, housings and cable.		
* For pH and ORP buffers, refer to page 171.		
Consumables		Order Number
Replacement electrolyte 3M KCl 250 ml		51 340 049
Replacement syringe for electrolyte refill		58 079 520
Housing		Order Number
SS flow housing		58 084 017

Cables (pHure Sensor LE ISM combination electrode with temperature compensator)	
Cable length	AK9
1m (3.3 ft)	59 902 167
3m (9.8 ft)	59 902 193
5m (16.4 ft)	59 902 213
10m (32.8 ft)	59 902 230
20m (65.6 ft)	52 300 204
30m (98.4 ft)	52 300 393
50m (164.0 ft)	52 300 394
80m (262.4 ft)	52 300 395

Cables (pHure Sensor LE combination electrode with RTD)	
Cable length	VP
1m (3.3 ft)	52 300 107
3m (9.8 ft)	52 300 108
5m (16.4 ft)	52 300 109
10m (32.8 ft)	52 300 110

pHure Sensor LE dimensions

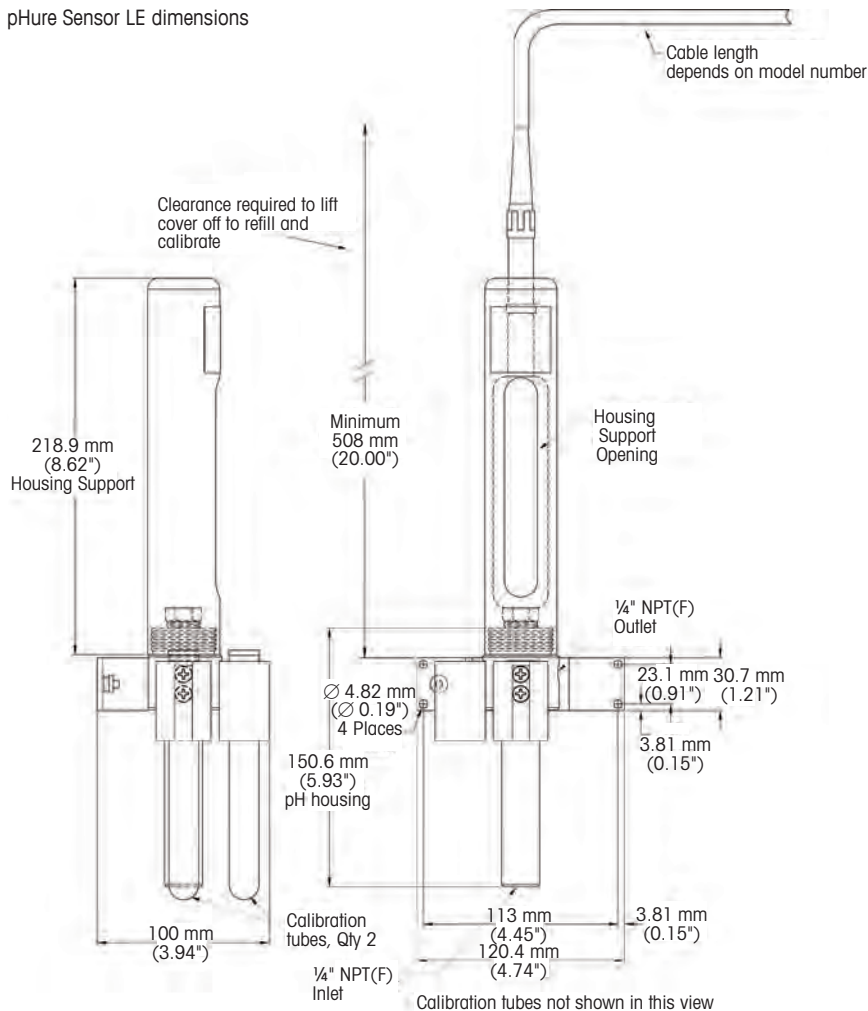

## pH/ORP Housings

### Flexibility in Meeting Process Requirements



METTLER TOLEDO Thornton housings provide a fixed NPT or solvent weld process connection. For easy access to the electrode for cleaning, calibration or replacement, they have internal O-ring seals with hand-tightened mounting nut. The compact METTLER TOLEDO electrode design includes measuring, reference and fast-responding temperature compensator functions so only a single process connection is ever needed.

Housings should be mounted to orient the tip of the electrode at least 15° below horizontal to ensure reliable contact of internal electrolyte with the measuring membrane. They should not be mounted horizontally or upside-down.

#### Specifications

pH Housings	Order Number		
	53 300 021	52 401 520	58 084 014
Wetted parts	CPVC	PVDF	PVC
Sensor fitting	¾" NPT(M) insertion or submersion <sup>a</sup>	¾" NPT(M) insertion or submersion <sup>a</sup>	1" weld tee
Pressure rating	7 bar(g) at 20 °C (100 psig at 68 °F) 2 bar(g) at 80 °C (30 psig at 176 °F)	6 bar(g) at 20 °C (87 psig at 68 °F) 1 bar(g) at 100 °C (15 psig at 212 °F)	3.5 bar(g) at 60 °C (50 psig at 140 °F)

Suitable pH sensors (by Order Number)<sup>b</sup>:

- 52 005 318	•	•	•
- 52 005 373	•	•	•
- 52 000 512	•	•	•
- 52 002 987	•	•	•
- 52 002 559	•	•	•
- 52 005 353	•	•	•
- 10 505 3288	•	•	•
- 10 505 3339	•	•	•

pH Housings	Order Number		
	58 084 002	58 084 003	58 084 004
Wetted parts	CPVC	PVDF	316 SS
Sensor fitting	Retractable 1½" NPT(M)	Retractable 1½" NPT(M)	Retractable 1" NPT(M)
Pressure rating	5 bar(g) at 80 °C (75 psig at 176 °F)	5 bar(g) at 100 °C (75 psig at 212 °F)	7 bar(g) at 100 °C (100 psig at 212 °F)

Suitable pH sensors (by Order Number)<sup>b</sup>:

- 52 005 382	•	•	•
- 52 002 989	•	•	•
- 59 904 152	•	•	•

<sup>a</sup> For insertion in plastic pipe, use ¾ × 1" reducing bushing and 1" pipe tee.

For submersion with plastic pipe, use ¾ × 1" reducing coupling and 1" pipe.

<sup>b</sup> For information about the corresponding pH sensors consult page 165.

**Drawings of pH housings**

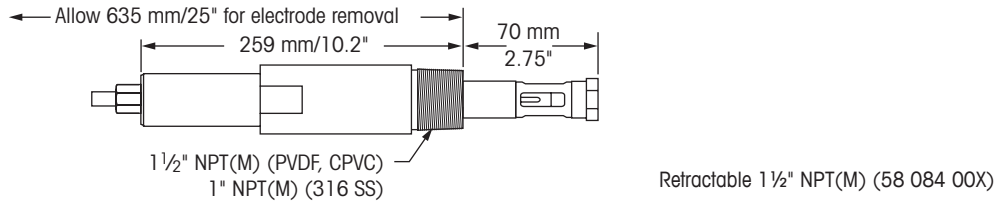
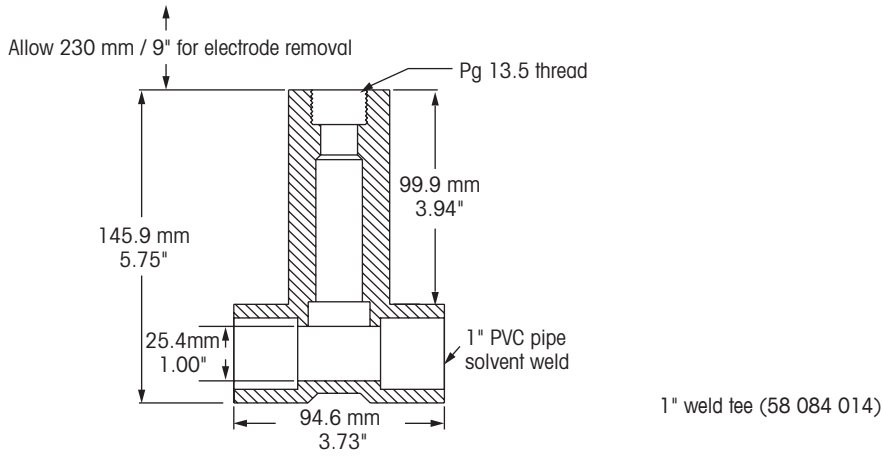
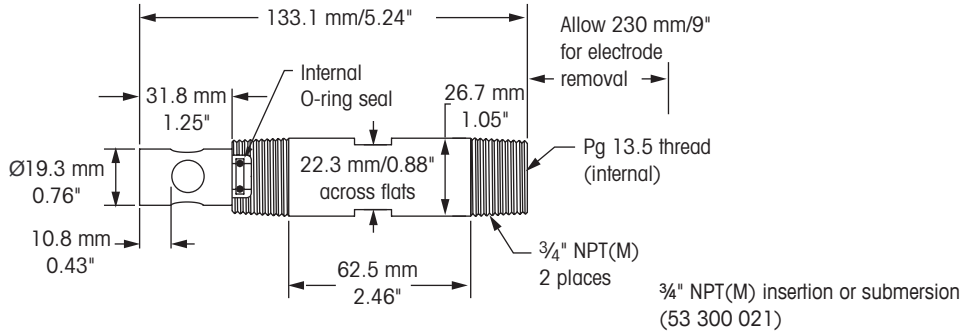

**pH and ORP (Redox) Standard Buffer Solutions**



**Ordering Information**

pH and Redox Buffers	Volume	Order Number
<b>pH Buffers</b>		
pH 4.01 buffer	250 ml	51 340 057
pH 7.00 buffer	250 ml	51 340 059
pH 9.21 buffer	250 ml	51 300 193
pH 10.00 buffer	250 ml	51 340 056
<b>Redox Buffers</b>		
Redox buffer 220 mV	6 × 250 ml	51 340 081

# Oxygen Measurement Systems

## High Reliability and Wide Application Coverage

**METTLER TOLEDO provides sensors to measure dissolved oxygen (DO) in demanding low ppb-level applications.**

### Measurement of dissolved oxygen

Proper oxygen levels are important in many processes involving the use of pure and ultrapure water. Control of dissolved oxygen will minimize corrosion, reduce costs or provide maximum semiconductor product yield.

### The optical dissolved oxygen sensor

with its durable OptoCap sensing element ensures fast response time, highly accurate measurement, very low maintenance, and no dissolved hydrogen interference.

### Electrochemical oxygen sensors

The Thornton high-performance sensors have been designed for in-line measurements of dissolved oxygen in the low ppb-range in power plant cycle chemistry and in ultrapure water applications of the semiconductor industry.

### Professional service and validation

Sensor service includes rebuilding, cleaning, testing, and recertification of your Thornton sensor, done quickly and efficiently to minimize downtime.



Optical DO Sensor



High Performance DO Sensor

# Ozone Measurement Systems

## Provide Accurate Response and Excellent Sensitivity

**METTLER TOLEDO Thornton's dissolved ozone measurement systems show rapid and accurate response to ozone concentrations. The excellent sensitivity gives positive detection of zero ozone after destruction by UV light.**

### Measuring principles

Ozone passes through a gas-permeable reinforced membrane of exceptional durability producing an electrochemical reaction and current flow in direct proportion. Behind the membrane is the platinum cathode where ozone reacts to produce the measurement signal. The electrochemical reaction is completed at the silver anode. Full temperature compensation accounts for effects of both membrane permeability and solubility of ozone in water.

### Important features

- Rapid, accurate response
- Positive zero detection
- Low maintenance with drop-in modular membrane

### Ozone sanitization of pharmaceutical water systems

Complete sanitization is achieved by controlling ozonation downstream of the storage tank. A second ozone measurement guarantees the removal of all ozone downstream of UV destruction.

### Ozone sanitization of semiconductor ultrapure water

Ozone sanitization can be controlled by monitoring the ozone concentration downstream of the ozonator and UPW storage tank. To be sure all ozone has been decomposed after UV lights, a second ozone measurement can confirm a zero level.

### Ozone sanitization of bottled water

Continuous measurement and control to proper ozone levels of bottled water is a required quality practice that promotes consistent good taste and long shelf life.

### Ozone sanitization of beverage systems

Ozonated water is used in place of chemicals for CIP operations when changing between flavors. Ozone provides cleaning and disinfection without risk of objectionable residuals or byproducts.



pureO<sub>3</sub> Dissolved Ozone Sensor

## Pure Water Optical DO Sensor

### Fast Response, Reduced Maintenance



**ISM®**

METTLER TOLEDO Thornton's Optical DO Sensor provides high accuracy, fast response and increased stability in demanding low ppb-level applications. The outstanding measurement performance with low detection limit, minimum drift and shorter response time improves oxygen monitoring. The proprietary OptoCap design allows highly accurate measurement of dissolved oxygen without susceptibility to hydrogen interference in power generation. The easy maintenance without liquid handling and polarization increases the availability of the measuring system. Easy maintenance, without liquid handling and sensor polarization increases the convenience of the measuring system. Predictive maintenance with ISM permits easy maintenance planning, reducing downtime.

#### Specifications

Operating range	0 – 5000 ppb
System accuracy	± 2 % of reading or 2 ppb, whichever is greater
Response time at 25 °C (77°F) (Air_N <sub>2</sub> )	98 % of final value in < 20 s
Sampling rate	Adjustable between 1 and 60 seconds
Sample flow rate	50 – 800 ml/min
Temperature compensation	Automatic
Measuring temperature range	0 – 50 °C (50 – 122 °F) for DO measure
Environmental temperature range	0 to 121 °C (32 to 250 °F)
Operating pressure	0.2 to 12 bar (2.9 to 174 psi absolute)
Design pressure	Maximum 12 bar (174 psi absolute)
Sample connections	¼" NPT(F)
Wetted materials	Stainless steel, silicone, EPDM O-ring
Cable length	2 – 50 m (6.6 – 164.0 ft)
Components needed	Optical DO probe, housing and cable

#### Construction

Measuring principle	Fluorescence quenching
Cable connection	5-pin
Connector design	Straight
Sensor body	316 L stainless steel
Membrane material	Silicone
O-ring material	EPDM (FDA-positive listed)
Sensor diameter	12 mm

#### Features Overview

- High accuracy
- Fast response
- Enhanced stability and reliability
- Reduced maintenance and downtime
- No dissolved hydrogen interference
- No flow sensitivity

#### Typical Applications

- Power plant cycle chemistry monitoring
- Generator stator cooling
- Semiconductor ultrapure water
- Pure water treatment systems



### Ordering Information

Optical DO Sensor	Order Number
Pure Water ISM Optical DO Probe	30 041 040
* All new installations require a sensor, housing and cable.	
Required Accessories	
Pure Water 316 Stainless Steel Housing	58 084 018
Sensor Cables	
2 m (6.6 ft)	52 300 379
5 m (16.4 ft)	52 300 380
10 m (32.8 ft)	52 300 381
15 m (49.2 ft)	52 206 422
25 m (82.0 ft)	52 206 529
50 m (164.0 ft)	52 206 530
Spare Parts	
OptoCap Replacement Kit	52 206 403
Accessories	
iSense full version	30 130 614
iSense lite version	Available for free
iSense mobile version	Available for free
iLink cable for iSense	52 300 399

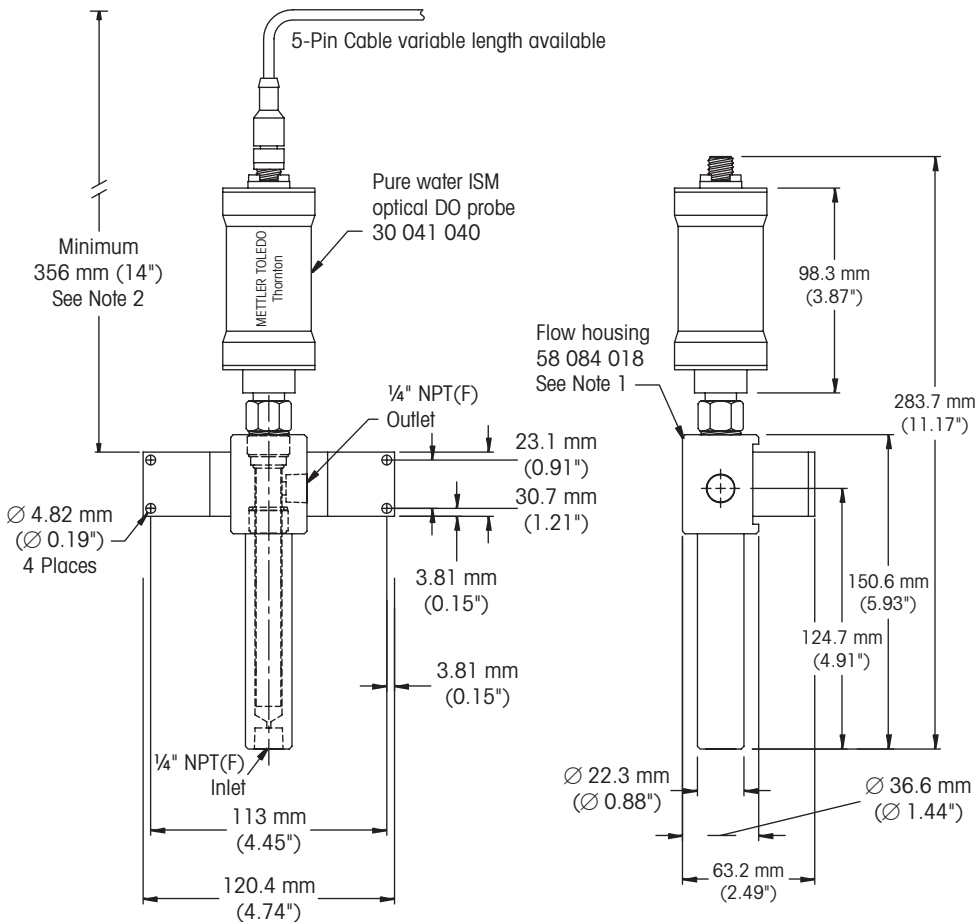

### Notes:

1. Electrode/Flow housing assembly must be in upright position as shown.
2. Allow at least 356 mm (14") clearance to remove sensor.

# High Performance Dissolved Oxygen Sensors with ISM

## Fast, Accurate Response



ISM®

METTLER TOLEDO Thornton's high performance ppb-level dissolved oxygen measurement capability excels in demanding low ppb-level applications. It provides a precise zero and a highly accurate response over the entire range of measurement. This allows it to perform well at any level as well as providing very fast response to changes from one level to another. The inclusion of ISM technology allows Plug and Measure capabilities, easier maintenance and convenient calibration.

### Specifications

Sample flow rate	50 to 1,000 ml/min
Sample temperature	0 to 60 °C (32 to 140 °F) for temperature compensation; can tolerate 100 °C (212 °F)
Sample pressure	0 to 5 bar(g) (0 to 72 psig)
Sample connections	1/4" NPT(M)
Wetted materials	Polyacetal flow housing, polyphenylene sulfide probe body, PTFE membrane reinforced with stainless steel and silicone rubber, Viton® and silicone rubber O-rings
Cable length	Probe to instrument: 1 to 80 m (3.3 to 262.4 ft)
Weight	1 kg (2 lb) with flow housing
Response time	98 % of final value in 90 s
Operating range	0–10,000 ppb (µg/L)
System accuracy	± 1 % of reading or 1 ppb, whichever is greater; ± 0.5 °C

### Features Overview

- High accuracy
- Simple maintenance with drop-in modular membrane
- Excellent long-term stability
- Temperature compensation for membrane permeability and oxygen solubility effects

### Typical Applications

- Power plant cycle chemistry monitoring
- Semiconductor ultrapure water
- Pure water treatment systems

### Ordering Information

High Performance Dissolved Oxygen Sensor	Order Number
ISM High Performance DO probe	52 201 209
Analog High Performance DO probe	52 201 067
Spare parts and Accessories for All High Performance Sensors	
Maintenance kit (electrolyte and 4 membranes)	52 200 024
Analog Polarization module (for portable use with VP cable)	52 200 893
DO electrolyte pack (3 × 25 ml)	30 298 424
Single membrane body	52 200 071
Flow housing	58 084 009

\* All new installations require a sensor, housing, cable and electrolyte.

Cables (High Performance Dissolved Oxygen probe ISM)	
Cable length	AK9
1m (3.3 ft)	59 902 167
3m (9.8 ft)	59 902 193
5m (16.4 ft)	59 902 213
10m (32.8 ft)	59 902 230
20m (65.6 ft)	52 300 204
30m (98.4 ft)	52 300 393
50m (164.0 ft)	52 300 394
80m (262.4 ft)	52 300 395

Cables (High Performance Dissolved Oxygen probe analog)	
Cable length	VP
1m (3.3 ft)	52 300 107
3m (9.8 ft)	52 300 108
5m (16.4 ft)	52 300 109
10m (32.8 ft)	52 300 110

Accessories	
iSense full version	30 130 614
iSense lite version	Available for free
iSense mobile version	Available for free
iLink cable for iSense	52 300 383

Dimensions of the ISM High Performance Dissolved Oxygen Sensor

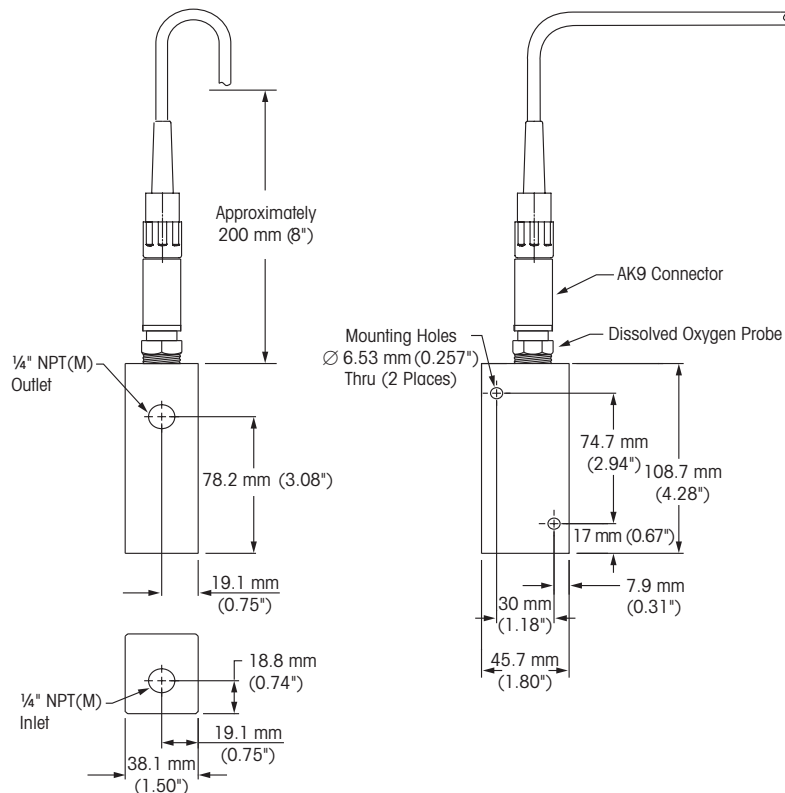

### Did You Know

The fast response of high performance DO sensors allows real-time tracking of start-up deaeration.

## pureO<sub>3</sub> Dissolved Ozone Sensor with ISM For Reliable Process Control



**ISM®**

The pureO<sub>3</sub><sup>™</sup> dissolved ozone sensor uses proven technology along with ISM for rapid and accurate response to a wide range of ozone concentrations. pureO<sub>3</sub> provides reliable ozone measurement in conjunction with many transmitters including various M800, M400, M300 and M200 ISM models. Intelligent sensor data is stored in memory, providing Plug and Measure simplicity with enhanced diagnostics capabilities. Robust sensor construction is coupled with a membrane cartridge which allows exceptionally fast and easy replacement of electrolyte and membrane when necessary.

### Specifications

Sample flow rate	200 to 500 ml/min with housing; 0.15 to 1 m/s (0.5 to 3 ft/s) without housing
Sample temperature	5 to 50 °C (41 to 122 °F) for compensation; probe can withstand 100 °C (212 °F)
Sample pressure	Normal operation, atmospheric; can withstand 0.8 to 3 bar absolute (0 to 45 psig)
Sample connections	1/4" NPT(F)
Wetted materials	Polycarbonate or 316 stainless steel flow housing, 316L/1.4404 stainless steel probe, silicone rubber membrane, FKM O-rings
Cable lengths	1 to 80 m (3.3 to 262.4 ft)
Weight	0.5 lb (227 g)
Response time	90% response in 30 s
Operating range	0–5,000 ppb (mg/L); 0–5.0 ppm (mg/L) short term; 0–500 ppb (mg/L); 0–0.5 ppm (mg/L) continuous
System accuracy	± 1% of reading or 0.4 ppb, whichever is greater

### Features Overview

- Reinforced silicone membrane for exceptional durability
- Full temperature compensation accounts for effects of both membrane permeability and solubility of ozone in water
- Membrane cartridge provides easy replacement of electrolyte and membrane

### Applications

- **Pharmaceutical water systems**  
Monitors sanitization levels and ensures removal of all ozone to satisfy the “no added substance” requirement
- **Semiconductor ultrapure water systems**  
Monitors ozone concentration downstream of the ozonator and UPW storage tank
- **Bottled water systems**  
Continuous ozone measurement is a key quality practice to provide good, consistent taste and long product shelf life
- **Beverage systems**  
Ozone replaces caustic chemicals for clean-in-place operations, providing disinfection without objectionable byproducts

▶ [www.mt.com/Thornton-Ozone](http://www.mt.com/Thornton-Ozone)

### Ordering Information

Ozone Sensor	Order Number
pureO <sub>3</sub> Dissolved Ozone sensor	30 139 305
<b>Required Accessories</b>	
Polycarbonate Housing	58 084 012
Stainless Steel Housing	58 084 020
<b>Spare Parts</b>	
pureO <sub>3</sub> membrane kit including electrolyte, 4 membranes and O-rings	30 235 170
Interior sensor body for pureO <sub>3</sub>	30 236 790
pureO <sub>3</sub> electrolyte, 25 ml	30 135 837
<b>ISM Sensor Cables</b>	
1.0m (3.3 ft)	59 902 167
3.0m (9.8 ft)	59 902 193
5.0m (16.4 ft)	59 902 213
10.0m (32.8 ft)	59 902 230
20m (65.6 ft)	52 300 204
30m (98.4 ft)	52 300 393
50m (164.0 ft)	52 300 394
80m (262.4 ft)	52 300 395

\* All new installations require a sensor, housing and cable.

### Dimensions

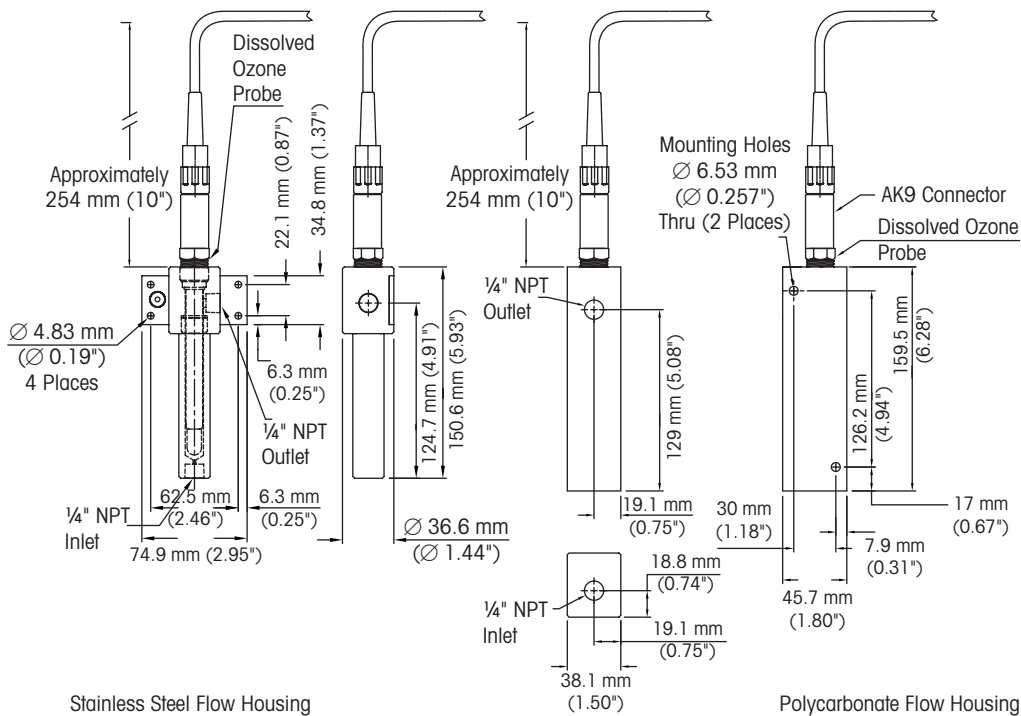

### Notes:

- Sensor/flow housing assembly must be in upright position as shown.
- Allow approximately 254 mm (10") clearance to remove sensor.

# Total Organic Carbon (TOC) ISM Technology

## Introduction to ISM Technology

The 6000TOC i Sensor uses Intelligent Sensor Management technology interfacing with the M800 Multi-parameter Analyzer/Transmitter. This technology allows the M800 to recognize the configuration and sensor parameters when connected. The M800 instrument will allow up to two or four 6000TOC i Sensors to be connected to any of the four input channels. Any remaining channels are available for use with any other ISM Sensors. The M800 also provides two pulse input channels for additional flow measurements.

The Sensor connects directly to the M800 instrument using standard patch cables. The 6000TOC i Sensor is designed to meet the requirements of today's industrial facilities with its CE and UL ratings. Combined with the M800 instrument it provides the most versatile and flexible TOC measurement platform available.

## Measurement technology UV Oxidation/Differential Conductivity

Thornton 6000TOC i, 4000TOC e and 450TOC products use proven ultraviolet oxidation with differential conductivity (see Figure 1) as the method to effectively determine TOC concentrations.



High performance digital conductivity sensors provide continuous conductivity measurement before and after sample oxidation. This is accomplished using a continuous flow-through spiral quartz tube design that allows the sample to flow continuously through the sensor. This design maximizes exposure to the 185 nanometer UV light, while minimizing measurement response time and providing complete oxidation. This simple and effective design requires no reagents or chemicals and has no moving mechanical components.

The formation of hydroxyl radicals in the water during UV exposure produces a mechanism through which bonds in non-ionic organic compounds are broken and oxidation occurs to form products such as carbon dioxide and water. The carbon dioxide dissolves

in the water and forms carbonic acid, which dissociates into ionic-conductive species. This change in conductivity is associated with TOC (see Figure 2).

## USP/EP and SST

In the Pharmaceutical Water production process, System Suitability Testing (SST) is an essential activity to verify the performance of a Total Organic Carbon monitoring system and to ensure its adequacy for TOC analysis.

## USP and EP Requirements

In the requirements for TOC measurement, the United States Pharmacopoeia and European Pharmacopoeia have established specific Total Organic Carbon (TOC) tests as described in USP General Chapter <643> and EP Chapter 2.2.44, respectively.

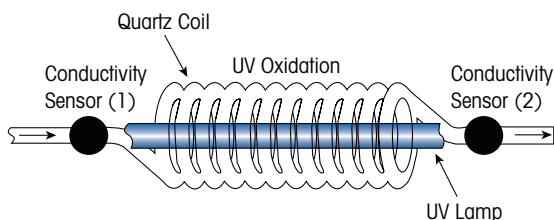

Figure 1

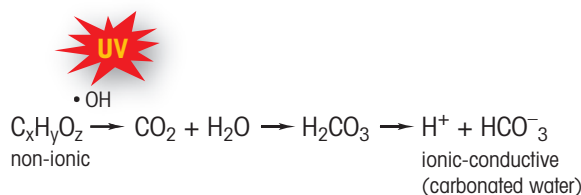

Figure 2

These chapters provide:

- Guidance on the methodology for TOC testing
- Criteria for establishing instrument acceptance
- TOC limits for the sample to be tested

### Challenges of System Suitability Testing

Because organic carbon appears in various forms in nature and subsequently in water treatment processes, a wide variety of oxidation states and chemical forms are found in these systems. The goal of System Suitability Testing is to challenge the TOC measurement technique by verifying that two chemicals of very different chemical properties respond equally. In this case, the two chemicals specified in the pharmacopeial chapters are sucrose and 1,4-benzoquinone. Because of their unique and different chemical structure, sucrose and 1,4-benzoquinone challenge the bond-breaking and oxidation capability of the TOC measurement technology.

These solutions are commonly referred to as easy to oxidize and hard to oxidize chemicals, respectively. In addition to sucrose and 1,4-benzoquinone, reagent water (the water used to manufacture the sucrose and 1,4-benzoquinone solutions) is analyzed during the suitability testing.

### How is TOC System Suitability Verified?

Once the measurements of sucrose, 1,4-benzoquinone and reagent water are complete, a simple calculation is applied:

1. Calculate the limit response by subtracting the Reagent Water ( $R_w$ ) TOC response from the response of the Sucrose ( $R_s$ ) Standard Solution. This is  $R_s - R_w$ .
2. Calculate the corrected System Suitability Solution response by subtracting the Reagent Water TOC response from the 1,4-benzoquinone TOC response. This is  $R_{SS} - R_w$ .
3. Fill in the responses to the following formula:

### Response Efficiency (%) =

$$100 \times \frac{R_{SS} - R_w}{R_s - R_w}$$

Response efficiency must fall within the limits as established in the table below:

### System Suitability Acceptance:

$\geq 85\%$  to  $\leq 115\%$

The TOC measurement system passes system suitability testing if the response efficiency is greater than or equal to 85% and less than or equal to 115%.

Feature	6000TOC i	4000TOC e	450TOC
Number of TOC sensors per transmitter	4	1	N/A
Measurement Range	0.05–2000 ppbC	0.05–1000 ppbC	0.05–1000 ppbC
Transmitter	M800	M300	N/A
Multi-parameter	Yes	No	No
Plug and Measure	Yes	Yes	N/A
USP, EP, JP and Ch. P Compliant	Yes	Yes	Yes
Continuous Measurement	Yes	Yes	Yes
Automatic Flow Control	Yes	Yes	Yes
ISM Capability	Yes	No	No
Semi-Automated Cal/SST	Yes	Yes	Yes

# Total Organic Carbon

A TOC Sensor with Reliable Performance

Total Organic Carbon

## 4000TOCe Easy to Use On-line Measurement



The enhanced 4000TOCe Sensor provides continuous on-line measurement of Total Organic Carbon in a low maintenance industrial package. In addition to using proven UV oxidation with differential conductivity to determine TOC concentration, the 4000TOCe model now features automatic flow control to ensure consistent water flow through the system.

### Features/Benefits

- On-line continuous measurement for fastest response
- Advanced UV lamp design extends stability and wavelength emission over lamp life
- Sample Conditioning Coil (included) can prevent CO<sub>2</sub> permeation into the water sample and will stabilize inlet flow, pressure and temperature irregularities
- Local LED Sensor status indication
- Continuous flow design provides rapid detection of system changes
- No gases or reagents to handle, store or replace and no moving parts minimize routine maintenance and service intervals
- Plug and measure sensor design reduces installation and setup time
- Real-time continuous monitoring for precise data trending and better process control
- Wide dynamic operating range meets the needs of pure and ultrapure water applications
- Meets USP <643>, <645>, EP 2.2.44, Ch.P and JP requirements for the Pharmaceutical Industry

### Applications

- Pure and Ultrapure water
- Pharmaceutical-grade water
- Recycle and reclaim
- Power generation

### 4000TOCe Sensor Ordering Information

Description	Order Number
4000TOCe Sensor, 110VAC, 50/60 Hz	30 415 866
4000TOCe Sensor, 220VAC, 50/60 Hz	30 415 867

### Accessories

Kit, Tool, TOC Sensor	58 091 520
Kit, Pipe mounting, for 1-1/2" nominal pipe size	58 091 521
High Pressure Inlet Regulator, 1/4" NPT-female	58 091 552
Outlet Drain Tube	58 091 553

### Consumables and Spare Parts

Replacement Inlet Filter Element, 60 micron (Pkg.2) (Recommended with lamp change)	58 091 551
Replacement UV Lamp (recommended every 4,500 hours of operation)	58 079 513
Kit, Fuse, Sensor PCB (for use on both 110 and 220 VAC models)	58 091 519
System Suitability Standards (For use with Cal/SST KIT 58 091 566)	58 091 526
Calibration Standards (For use with Cal/SST KIT 58 091 566)	58 091 529
Combined Calibration and SST Standards (For use with Cal/SST KIT 58 091 566; contains 58 091 526 and 58 091 529)	58 091 537

### For use with M300TOC Transmitters

Description	Order Number
M300TOC ¼ DIN Enclosure (Panel mounting kit included)	30 414 214
M300TOC ½ DIN Enclosure	30 414 212

▶ [www.mt.com/Thornton-TOC](http://www.mt.com/Thornton-TOC)



## Specifications

### 4000TOCe Sensor

Measurement range	0.05 – 1000 ppbC ( $\mu\text{gC/L}$ )
Accuracy	$\pm 0.1$ ppb C for TOC < 2.0 ppb (for water quality > 15 M $\Omega$ -cm [0.067 $\mu\text{S/cm}$ ]) $\pm 0.2$ ppb C for TOC > 2.0 ppb and < 10.0 ppb (for water quality > 15 M $\Omega$ -cm [0.067 $\mu\text{S/cm}$ ]) $\pm 5\%$ of measurement for TOC > 10.0 ppb (for water quality 0.5 to 18.2 M $\Omega$ -cm [2.0 to 0.055 $\mu\text{S/cm}$ ])
Repeatability	$\pm 0.05$ ppb C < 5 ppb, $\pm 1.0\%$ > 5 ppb
Resolution	0.001 ppbC ( $\mu\text{gC/L}$ )
Analysis time	Continuous
Initial response time	< 60 s
Limit of detection	0.025 ppbC

### Conductivity Sensor

Conductivity accuracy	$\pm 2\%$ , 0.02-20 $\mu\text{S/cm}$ ; Constant Sensor <sup>a</sup>
Cell constant accuracy	$\pm 2\%$
Temperature sensor	Pt 1000 RTD, Class A
Temperature accuracy	$\pm 0.25^\circ\text{C}$

### Sample Water Requirements

Temperature	0 to 100 $^\circ\text{C}$ <sup>b</sup>
Particle size	< 100 micron
Minimum water quality	$\geq 0.5$ M $\Omega$ -cm ( $\leq 2$ $\mu\text{S/cm}$ ), pH < 7.5 <sup>c</sup>
Flow rate	$\geq 20$ mL/min
Pressure	0.3 bar(g) to 6.9 bar(g) (4 to 100 psig) at sample inlet connection <sup>d</sup>

### General Specifications

Case dimensions	280 mm (11") W $\times$ 188 mm (7.4") H $\times$ 133 mm (5.25") D
Weight	2.3 kg (5.0 lb)
Enclosure material	Polycarbonate plastic, flame retardant, UV and chemical resistant UL # E75645, Vol.1, Set 2, CSA # LR 49336
Enclosure rating	NEMA 4X, IP65 Industrial environment
Ambient temperature/ Humidity rating	5 to 50 $^\circ\text{C}$ (41 to 122 $^\circ\text{F}$ )/5 to 80% Humidity, non-condensing
Power requirements	100 – 130 VAC or 200 – 240 VAC, 50/60 Hz, 25 W Maximum
Local indicators	Four LED lights for Fault, Error, Sensor Status and UV Lamp ON
Ratings/approvals	CE Compliant, UL and cUL (CSA Standards) listed, Conductivity and temperature sensors traceable to NIST, ASTM D1125 and D5391. Meets ASTM D5173 Standard Test Method for On-line Monitoring of Carbon Compounds in Water by UV Light Oxidation

### Sample Connections

Inlet connection	3 mm (0.125") O.D. (2 m (6") FDA compliant PTFE tubing supplied)
Outlet connection	6 mm (0.25") O.D. Barb connection (1.5 m (5") flexible tubing provided)
Inlet filter	316 SS, in-line 60 micron
Wetted parts	316 SS/Quartz/PEEK/Titanium/PTFE/EPDM/FFKM
Wall mount	Standard, mounting tabs provided
Pipe mount	Optional, with pipe-mount bracket accessory for nominal pipe sizes 2.5 cm (1")
Maximum sensor distance	91 m (300')

<sup>a</sup> Readout in equivalent S/m ranges selectable at M300TOC.

<sup>b</sup> Temperature above 70 $^\circ\text{C}$  requires Sample Conditioning Coil (included).

<sup>c</sup> For power plant cycle chemistry samples, pH may be adjusted by measurement after cation exchange.

<sup>d</sup> Process pressure above 5.9 bar(g) (85 psig) requires optional High Pressure Regulator p/n 58 091 552.

### Dimensions

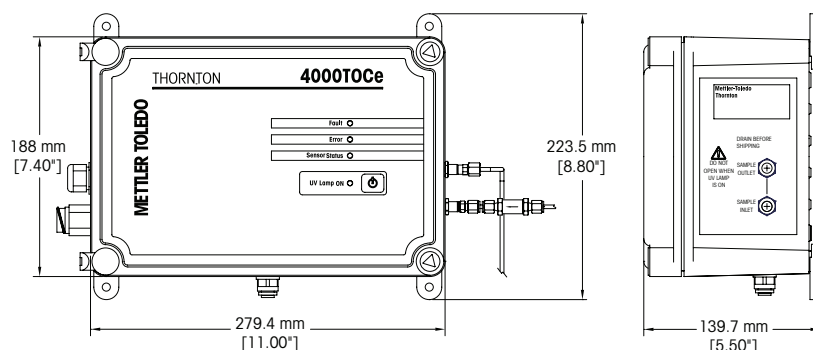

## Total Organic Carbon

A TOC Sensor with Real-Time Continuous Measurement

Total Organic Carbon

# 6000TOC i

## On-line, Fast and Continuous



The 6000TOC i total organic carbon sensor provides true continuous measurement, refreshing every second, for immediate detection of organic contamination. Its dependable and reliable design uses proven UV oxidation technology for real-time TOC monitoring of your critical water systems. Easily and efficiently monitor TOC levels from post RO waters to point-of-use so you will never miss an excursion. Constructed with the user in mind, its intuitive interface and flexible Plug and Measure design requires no reagents or chemicals for operation.

ISM®



### Features/Benefits

- On-line continuous measurement
- Meets USP <643>, <645>, EP 2.2.44, Ch.P and JP requirements for the Pharmaceutical Industry
- Semi-automated Calibration and System Suitability Test
- Intelligent Sensor Management (ISM) Interface
- Intelligent diagnostics with iMonitor
- Peak, Average and Rate-of-Change TOC measurement for compliance monitoring
- Compatible with M800 multi-parameter transmitter
- Install up to four TOC sensors to one M800 transmitter
- USB printer capable
- USB for data logging
- Automated flow control
- At-a-glance LED status
- Universal Power Ballast

### True Continuous Measurement

With an initial response rate of less than a minute and measurement updates every second, the 6000TOC i is ideal in all pure water applications where rapid detection of TOC changes is critical.

### Stable and reliable analysis

With highly stable and reproducible TOC measurements, you can be confident that you have the control over your water system that is required to meet regulatory and internal water quality specifications.

**Verifiable system performance** Intelligent Sensor Management (ISM) advanced diagnostics help ensure your sensor performs optimally at all times.

### Supports regulatory compliance

For regulated industries, the 6000TOC i Sensor and M800 Transmitter provide a fully compliant solution. They satisfy the requirements of all major global pharmacopeias for TOC instrumentation, including USP, EP, JP, ChP and IP.

► [www.mt.com/6000TOCi](http://www.mt.com/6000TOCi)

## Specifications

### 6000TOCi Sensor

Measurement range	0.05 – 2000 ppbC (µgC/L)
Accuracy	±0.1 ppbC for TOC <2.0 ppbC (for water quality >15 MΩ-cm [0.067 µS/cm]) ±0.2 ppbC for TOC >2.0 ppbC and <10.0 ppbC (for water quality >15 MΩ-cm [0.067 µS/cm]) ±5% of measurement for TOC >10.0 ppbC (for water quality 0.5 to 18.2 MΩ-cm [2.0 to 0.055 µS/cm])
Repeatability	±0.05 ppbC < 5 ppbC, ±1.0% > 5 ppbC
Resolution	0.001 ppbC (µgC/L)
Analysis Time	Continuous
Initial Response Time	<60 seconds
Update Rate	1 second
Limit of Detection	0.025 ppbC

## Specifications

### Conductivity Sensor

Conductivity Accuracy	±2%, 0.02–20 µS/cm ±3%, 20–100 µS/cm*
Cell Constant Accuracy	±2%
Temperature Sensor	Pt1000 RTD, Class A
Temperature Accuracy	±0.25°C

### Sample Water Requirements

Temperature	0 to 100°C (32 to 212 °F)**
Particle Size	<100 micron
Minimum Water Quality	≥0.5 MΩ-cm (≤ 2 µS/cm), pH < 7.5***
Flow Rate	> 8.5 mL/min
Pressure	0.3 bar(g) to 13.6 bar(g)/4 to 200 psig at sample inlet connection****

### General Specifications

Case Dimensions	302.75 mm (11.9") W × 229.8 mm (9") H × 144.7 mm (5.7") D
Weight	5 kg (11.0 lb)
Enclosure Rating	IP55
Enclosure Material	Ignition Resistant Polystyrene Resin meeting UL 94V-0, Painted Aluminum
Ambient Temperature/Humidity Rating	5 to 50°C (41 to 122 °F)/5 to 80% Humidity, non-condensing
Power Requirements	100–240 VAC, 50–60 Hz, 25W
Local Indicators	Four LED lights for Fault, Error, Sensor Status and UV Lamp ON
Ratings/Approvals	CE Compliant, UL and cUL (CSA Standards) listed. Conductivity and temperature sensors traceable to NIST, ASTM D1125 and D5391. Meets ASTM D5173 Standard Test Method for On-Line Monitoring of Carbon Compounds in Water by UV Light Oxidation

### Installation/Power/Enclosure

Inlet Connection	3 mm (0.125") O.D. (1.83 m [6 ft] FDA compliant PTFE tubing supplied)
Outlet Connection	3 mm (0.125") O.D. (165 mm [6.5"] fixed 316 SS tube provided)
Inlet Filter	316 SS, inline 60 micron
Wetted Parts	316 SS/Quartz/PEEK/Titanium/PTFE/EPDM
Wall Mount	Standard, mounting bracket provided
Maximum Sensor Distance	91 m (300 ft)

\* Readout in equivalent S/m ranges selectable at M800

\*\* Temperature above 70 °C requires Sample Conditioning Coil (included)

\*\*\* For power plant cycle chemistry samples, pH may be adjusted by measurement after cation exchange.

\*\*\*\* Process pressure above 5.9 bar(g)/85 psig requires optional High Pressure Regulator p/n 58 091 552.

Specifications subject to change without notice.

## Total Organic Carbon

A TOC Sensor for Critical Water Release

### Ordering information

Sensor	Order no.
6000TOC i Sensor, 100–240VAC 50–60 Hz	30 472 150
6000TOC i Sensor, Low ppb calibration, 100–240VAC 50–60 Hz	30 472 151
Transmitter	
M800 Water 2-channel	58 000 802
M800 Water 4-channel	58 000 804
M800 DP 2-channel	58 000 806
Accessories	
Pump Module, 6000TOC i	30 472 152
Inlet Filter Assembly, High Capacity	58 091 550
High Pressure Regulator	58 091 552
Accessories – Cords	
Patch Cord, 0.3 m (1 ft)	58 080 270
Patch Cord, 1.5 m (5 ft)	58 080 271
Patch Cord, 3.0 m (10 ft)	58 080 272
Patch Cord, 4.5 m (15 ft)	58 080 273
Patch Cord, 7.6 m (25 ft)	58 080 274
Patch Cord, 15.2 m (50 ft)	58 080 275
Patch Cord, 30.5 m (100 ft)	58 080 276
Patch Cord, 45.7 m (150 ft)	58 080 277
Patch Cord, 61.0 m (200 ft)	58 080 278
Patch Cord, 91.4 m (300 ft)	58 080 279
Consumables & Spare Parts	
Replacement UV Lamp	58 079 513
Calibration Standards	30 472 083
System Suitability Test Standards	30 472 084
Combined Calibration and System Suitability Test Standards	30 472 085
Calibration Standards for Extended Range Calibration	30 472 086
Combined Calibration and System Suitability Test Standards for Extended Range Calibration	30 472 087
Fuse, 1.25A, Sensor PCB	58 091 583
Inlet Filter Replacement	58 091 551

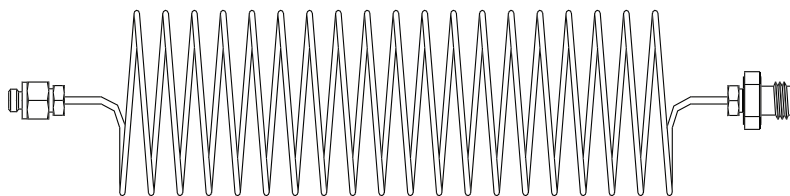

#### Did You Know

The sample conditioning coil optimizes the 6000TOC i sensor performance under adverse conditions such as:

- High sample temperature
  - A highly humid environment
  - Varying inlet pressure
- It also prevents CO<sub>2</sub> ingress into the sample.

### System Suitability Testing

Since the 6000TOC i sensor provides continuous monitoring, the system suitability test can be performed far faster than other TOC measurement technologies which rely on lengthy batch measurement or laboratory analysis. During the System Suitability Test, the operation of the instrument is identical to normal operating conditions with no extra oxidation cycle times. The solutions are easily introduced into the system, and results are available in minutes.

The system suitability test kit from Thornton provides the equipment needed to perform a system suitability test on the 6000TOC i Sensor. The system suitability test kit is designed for use with the system suitability standards solutions kit available from Thornton. The Solutions Kit includes one bottle of 500 ppb sucrose, one bottle of 500 ppb 1,4-benzoquinone and two bottles of reagent TOC water. The solutions are produced from USP Reference Standards for assured consistency, quality and compliance.

### Dimensions

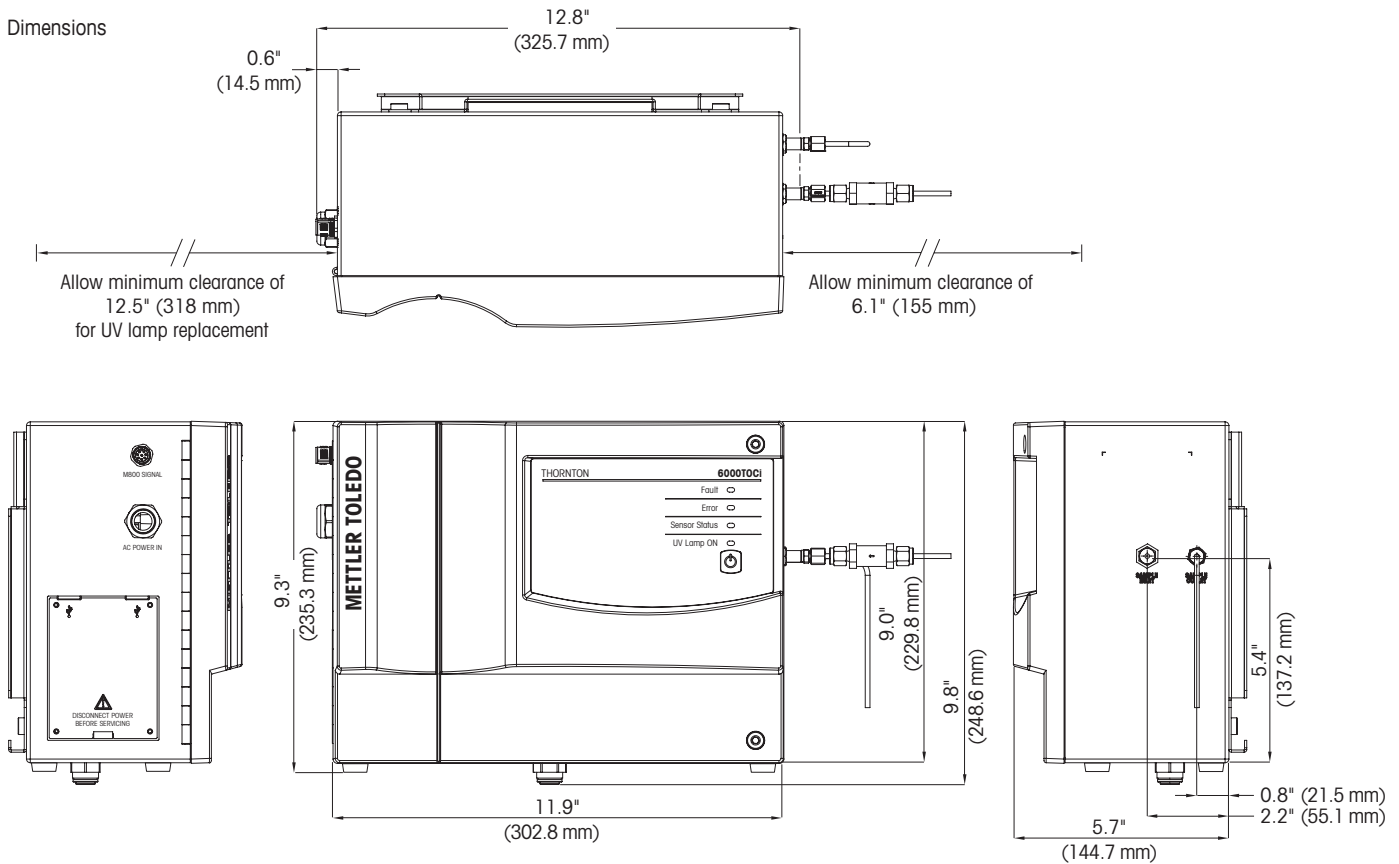

## 450TOC

### Portable TOC Measurement



The 450TOC Total Organic Carbon analyzer from METTLER TOLEDO Thornton offers the fastest response to TOC changes available in a portable TOC system. With its robust, portable design the 450TOC is an ideal tool for multi-point TOC measurement for point-of-use monitoring, water system diagnostics, and maintenance verification.

#### Portable, Real-time TOC Measurement

- Reduce system and component verification time by 80% with portable, real-time total organic carbon analysis
- Ensure 100% system compliance with fast, simple and easy point-of-use monitoring
- Reduce system diagnostics time by 80% with fast, on-the-spot test results for TOC and conductivity
- Quickly capture and analyze results with on-board USB stick data collection and simple export to spreadsheet programs
- Eliminate costly sampling errors by bringing the measurement directly to the sampling point

#### Other Highlights

- Continuous measurement technology for superior system profiling and performance trending
- USB printer support for hard-copy record keeping
- Compliant with USP, EP, Ch P and JP



Dimensions	With Base	Without Base
A	349 mm (13.75")	324 mm (12.75")
B	358 mm (14.1")	334 mm (13.15")
C	192 mm (7.56")	185 mm (7.30")

[www.mt.com/450TOC](http://www.mt.com/450TOC)

## Specifications

<b>450TOC Sensor</b>	
Measurement range	0.05 – 1000 µgC/L (ppbC)
Accuracy	±0.1 ppbC for TOC < 2.0 ppb (for water quality > 15 MΩ-cm) ±0.2 ppbC for TOC > 2.0 ppb and < 10.0 ppb (for water quality > 15 MΩ-cm) ±5 % of measurement for TOC > 10.0 ppb (for water quality 0.5 to 18.2 MΩ-cm)
Repeatability	±0.05 ppbC < 5 ppb, ±1.0% > 5 ppb
Resolution	0.001 ppbC (µgC/L)
Analysis time	Continuous
Initial response time	< 60 s
Limit of detection	0.025 ppbC
<b>Conductivity Sensor</b>	
Conductivity accuracy	±2 %, 0.02 to 20 µS/cm; ±3 %, 20–100 µS/cm
Cell constant accuracy	±2 %
Temperature sensor	Pt 1000 RTD, Class A
Temperature accuracy	±0.25 °C
<b>Sample Water Requirements</b>	
Temperature	0 to 70 °C
Particle size	< 100 micron
Minimum water quality	≥ 0.5 MΩ-cm (≤ 2 µS/cm), pH < 7.5*
Flow rate	20 mL/min
Pressure	0.3 to 5.8 bar (4 to 85 psig) at sample inlet connection
<b>General Specifications</b>	
Overall dimensions	334 × 185 × 324 mm (13.15" L × 7.3" W × 12.75" H)
Sample connections	3 mm (0.125") O.D. (2 m {6"} FDA compliant PTFE tubing supplied)
Weight	With base: 7.0 kg (15.4 lb); without base: 6.1 kg (13.6 lb)
Wetted parts	316 SS/quartz/PEEK/titanium/PTFE/silicone/FFKM/EPDM
Power requirements	100–240 VAC, 50/60 Hz, 40 W maximum
Ratings/approvals	CE Compliant, cULus Listed. Conductivity and temperature sensors traceable to NIST and ASTM D1125 and D5391 Meets ASTM D5173 Standard Test Method for On-Line Monitoring of Carbon Compounds in Water by UV Light Oxidation

\* For power plant cycle chemistry samples, pH may be adjusted by measurement after cation exchange.

Specifications subject to change without notice.

## 450TOC Portable Analyzer Ordering Information

Description	Order Number
450TOC Portable Analyzer	58 036 041
Accessories	Order Number
450TOC protective base	58 091 585
Kit, ISM calibration and System Suitability Test (SST and calibration standards sold separately)	58 091 566
Stand, calibration and System Suitability Test kit	58 091 586
Case, 450TOC storage and transport, hard walled	58 091 587
High pressure regulator	58 091 552

## TOC Pump Module

### Valveless Design, Drift-Free Performance



The Pump Module uses a precision, positive displacement pump to provide a highly stable, metered flow of process water to the TOC sensor to ensure reliable and consistent TOC measurement performance. This accessory is recommended for applications where system pressure is either too low to provide adequate flow through the TOC sensor, or for low pressure applications where system pressure may vary routinely during operation. The Pump Module is ideally suited for applications such as distillation, RO permeate, CIP and pharmaceutical washing.

#### Features Overview

- Positive displacement pumping mechanism
- Flow rate independent of supply pressure
- Requires only a wetted-suction for operation
- Flow pre-set for 20 ml/min or 8.5 ml/min
- Universal AC supply



**Installation Diagram**

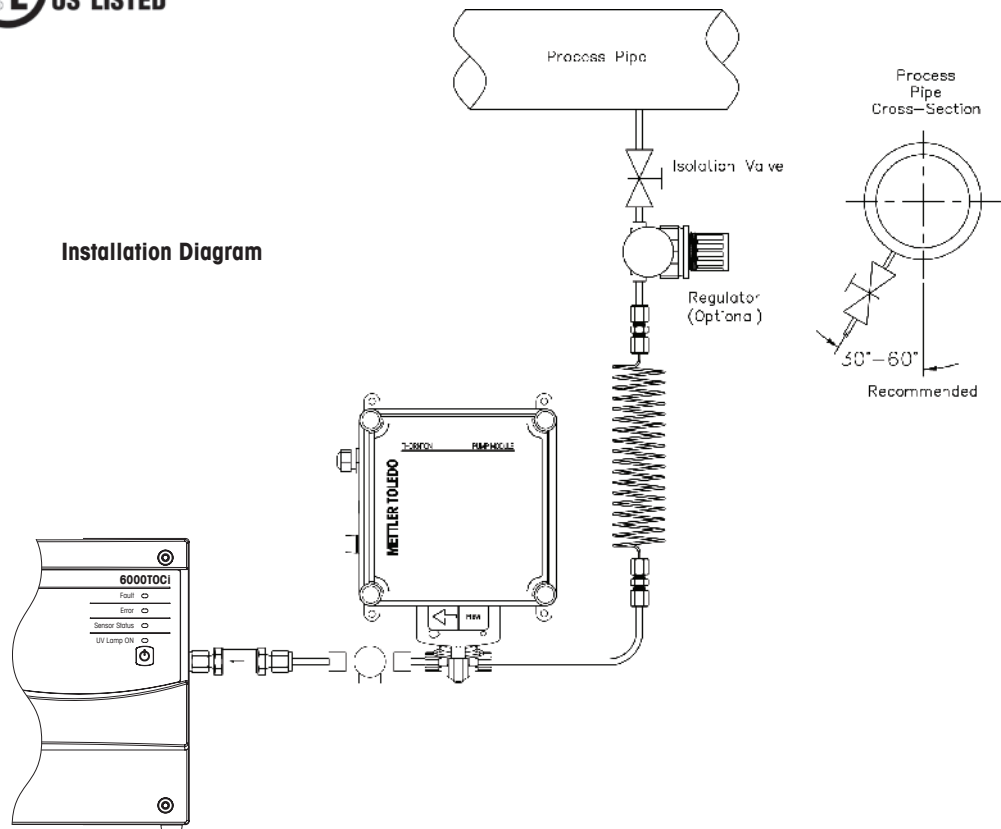

[www.mt.com/Thornton-TOC](http://www.mt.com/Thornton-TOC)



## Ordering Information

Description	Order Number
Pump Module 20 ml/min (for use with the 4000TOCe sensor)	58 091 565
Pump Module 8.5 ml/min (for use with the 6000TOCi sensor)	30 472 152
<b>Pump Module Spare Parts</b>	
Pump Seal Replacement Kit	58 091 020
Replacement Fitting Kit	58 091 021
Replacement Fuse (Fuse rating 250V 0.375A 5 × 20 mm Type 'T' [Time Log])	58 091 024
Pulsation Dampener with Interconnect	58 091 025
Pulsation Dampener Bellows Replacement Kit with Seal	58 091 026

## Specifications

Sample Water Requirements	
Temperature	0 to 100 °C*
Particle size	< 100 micron
Flow rate	20 ± 0.5 ml/min; 8.5 ± 0.25 ml/min
Pressure	Flooded suction to 0.69 bar(g) (10 psig) at sample inlet connection
General Specifications	
Overall dimensions	188 mm (7.4") W × 188 mm (7.4") H × 133 mm (5.25") D
Sample connections	Inlet 3 mm (0.125") O.D. (2 m (6') FDA compliant PTFE tubing supplied) Outlet 3 mm (0.125") O.D.
Weight	2.3 kg (5.0 lb.)
Ambient temperature/Humidity rating	5 to 50 °C/5 to 80 % humidity, non-condensing
Enclosure material	Polycarbonate plastic, flame retardant, UV and chemical resistant UL #E75645, Vol.1, Set 2, CSA #LR 49336
Power requirements	100–240VAC, 50/60 Hz, 0.2A
Wall mount	Standard, mounting tabs provided
Ratings/Approvals	CE Compliant, UL and cUL (CSA Standards) listed. Not NEMA or IP rated

\* Temperature above 70 °C requires Sample Conditioning Coil p/n 58 079 518

## Dimensions

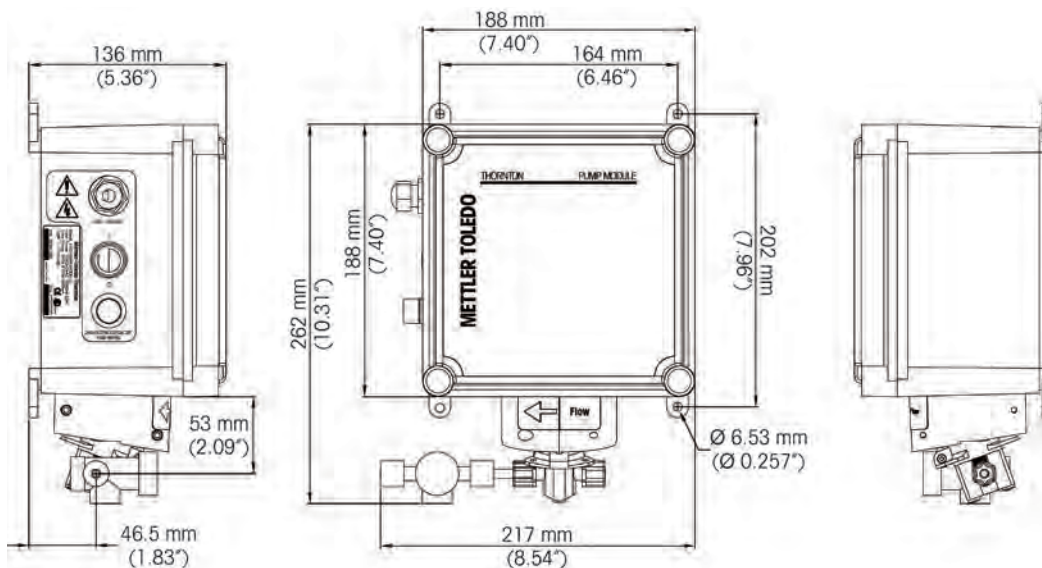

## Microbial Detection Analyzer

Real-time Monitoring of Microbial Contamination

Microbial Contamination

# 7000RMS Microbial Detection Analyzer

## Continuous, At-line and Dependable

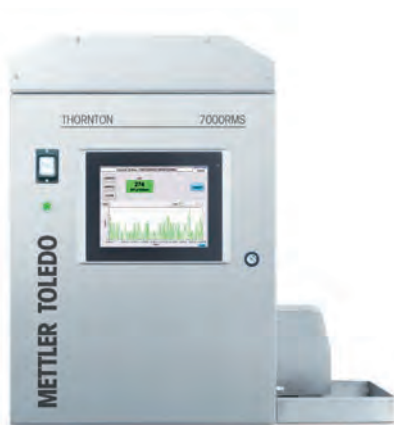

METTLER TOLEDO Thornton's 7000RMS™ (Real-time Microbial System) is an at-line analyzer for real-time measurement of microbial contamination (bioburden) in Pharmaceutical Waters. Advanced, laser-induced fluorescence and Mie scattering measurement technology provides immediate detection and quantification of microorganisms. The compact analyzer overcomes limitations of growth-based technologies that are dependent on incubation conditions, growth media, reagents and time.

The 7000RMS enables risk reduction and greater process control, and offers significant costs savings from the combined decrease in laboratory testing and false-positive results.

### Features/Benefits

- Continuous results every 2 seconds, no incubation or preparation needed
- Laser-induced fluorescence allows for the measurement of AFU
- Detection is not based on organisms forming a colony
- Increase process control by monitoring/reacting to water system trends prior to an out-of-specification event
- Reduce risk of releasing contaminated water
- Convenient touchscreen display with intuitive user interface
- Monitor at-line
- Alarms for alert, action and breach limits
- SCADA connectivity, analog output, Ethernet and Modbus compatible

### Typical Applications

Continuous monitoring of PW, WFI and UPW

- Distribution loops
- Sub loops
- Return loops
- Recirculating storage tanks
- Post purification before storage
- Sampling points

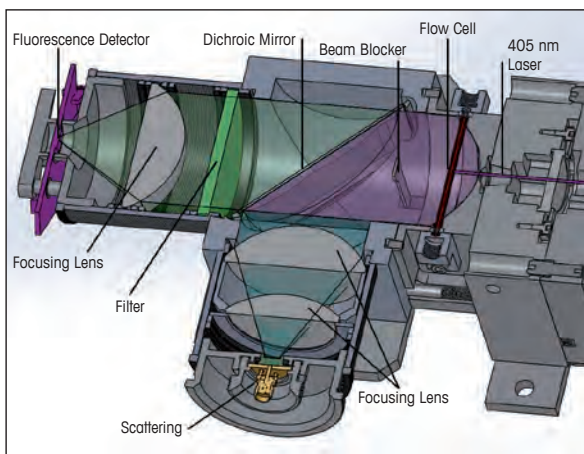

Cross-section drawing of the optical detection system

[www.mt.com/7000RMS](http://www.mt.com/7000RMS)

## Specifications

### 700RMS Analyzer

#### General Specifications

Flow rate	30 mL/min
Detection limit	1 AFU (Auto Fluorescent Units)
Minimum detection size	≥ 0.3 µm
Measurement range	0–10,000 AFU/mL
Analysis time	Continuous
Response time	2 seconds (1 mL)
Data communication	<ul style="list-style-type: none"> <li>– Ethernet - standard RJ 45 / Wi-Fi capable</li> <li>– SCADA connectivity via Modbus TCP</li> <li>– Analog output channels; 4–20 mA standard, with configurable output ranges</li> <li>– USB</li> </ul>

#### Water Requirements

Temperature (non-condensing)	5–90 °C (41–194 °F)*
Inlet pressure	2–5.5 bar(g) (20–80 psig)**1
Type/Quality	Purified Water (PW), Ultrapure Water (UPW), Water for Injection (WFI)

#### Power/Installation/Enclosure

Power requirements	100–240 VAC, 50–60 Hz, 5A Use the power cord included with the instrument 2.5 m (8.2 ft) cord length provided standard
Monitoring location	At-line to drain
Ambient temperature (non-condensing)	0–37 °C (32–98.6 °F)*
Inlet connection	3 mm (0.125") O.D.
Outlet connection	3 mm (0.125") O.D.
Wall mount	Anti-vibration shelf required (P/N 58 079 700)
Enclosure material	Stainless steel
Physical dimensions (W × H × D)	56.4 cm × 61.6 cm × 30.5 cm (22.2" × 24.25" × 12")
Weight	33.3 kg (73.4 lbs)

#### Environmental Conditions

Use	Indoor use
Altitude	Up to 2000 m (6562 ft)
Environmental Temperature	5–35 °C (41–95 °F)
Environment	Pollution degree 2
Humidity (non-condensing)	80% maximum relative humidity up to 31 °C (87.8 °F) decreasing linearly to 50% relative humidity at 40 °C (104 °F)
Voltage	MAINS supply voltage fluctuations up to ±10% of the nominal voltage of 100–240 VAC 50–60 Hz TRANSIENT OVERVOLTAGES: up to levels of OVERVOLTAGE CATEGORY II TEMPORARY OVERVOLTAGES occurring on the MAINS SUPPLY

\* Temperature below 15 °C or above 45 °C requires Sample Conditioning Coil (included)

\*\* Process pressure above 80 psig (5.5 bar(g)) requires optional High Pressure Regulator (P/N 58 091 552)

<sup>1</sup> Calibration, cleaning and grab sample requires sample pressure of 0 psig (0 bar(g))



The 700RMS analyzer is certified as a Class 1 laser product. The 700RMS unit contains a Class 3B Laser System, as specified by IEC 60825-1 Ed.3 (2014).

## Ordering Information

Description	Order Number
700RMS Microbial Detection Analyzer	58 045 001

## 2300Na Sodium Analyzer

### High Sensitivity, Low Maintenance



The METTLER TOLEDO Thornton 2300Na Sodium Analyzer offers a new approach for a traditional measurement in pure/ultrapure water treatment and power cycle chemistry monitoring. This analyzer provides assurance of water purity to minimize corrosion and maximize water production during power generation. It also ensures water purity in microelectronics production through early detection of breakthrough in cation resin during ultrapure water treatment. Early detection of trace contamination is enabled with minimal operator supervision.

#### Features/Benefits

- Fully automatic, unattended calibration: ensures reliable operation while saving technician time
- Reagent addition confirmation by pH: ensures reliable measurement results
- Convenient grab sample measurement: for additional samples and QC checks for other areas of the plant
- Slow and complete reagent consumption: saves reagent costs and eliminates waste disposal issues
- Simultaneous display of sodium, adjusted pH, temperature and calibration progress: provides convenient analyzer and sample status at a glance, saving operator time
- Automated electrode conditioning with each calibration: minimizes the need for electrode etching
- Choice of two enclosures: full locking door for dirty plant environments or with controls conveniently accessible for clean sample rooms
- Four analog outputs for sodium, pH and temperature with choice of scaling: enables full integration into data acquisition or control systems

#### Typical Applications

- Ultrapure water monitoring at sub-ppb sodium levels
- Cation exchange monitoring in pure water treatment detects the first breakthrough of sodium
- Power steam quality monitoring protects turbines from sodium attack
- Power condensate monitoring detects small leaks early to allow time to plan corrective action

## Specifications

Measurements	
Range, sodium	0.001 – 100,000 ppb or equivalent ppm, autoranging
Resolution, sodium	4 digits with decimal, autoranging; 0.001 ppb in lowest range
Accuracy, sodium	± 10% of reading ± 0.05 ppb
Response time (90%)	5 min
Update rate	Once per second
Reagent consumption	Diisopropylamine (DIPA), approximately 1 L per 3 months; more at higher temperatures and for cation exchange samples
Sample pH	2.5 – 12
Sample flow rate	> 40 mL/min (> 20 mL/min for cation exchange samples), excess to drain
Sample temperature	5 – 50 °C (41 – 122 °F)
Sample pressure	0.3 – 7 bar(g) (5 – 100 psig)
Calibration	Automatic, unattended 3-point known addition; manual 1- or 2-point
Electrode conditioning	Part of auto-cal sequence
Grab sample measurement	Included
Range, pH	0.00 – 14.00 pH, reagent conditioned sample
Range, temperature	0 – 100 °C (32 – 212 °F)
Outputs	
Analog outputs	For sodium, conditioned pH, temperature; four powered 0/4 – 20 mA, 22 mA alarm, 500 ohm max load, not for use with externally powered circuits
Analog output scaling	Linear, bi-linear, logarithmic (1, 2, 3 or 4 decades) or auto ranging
Analog output accuracy	± 0.05 mA
Relay contacts	Two unpowered, SPDT, 250 VAC/30 VDC, 3 A resistive freely assignable to setpoints for sodium, pH, temperature; other relays used for auto-cal
Installation/Power/Enclosure	
Operator interface	4-line backlit LCD, 5 tactile keys; simultaneous display of sodium, conditioned pH, auto-cal status (temperature optional)
Connections	Sample inlet: 1/4" or 6 mm OD tube SS compression fitting Drain hose: 19 × 25.4 mm (¾ × 1"), 2 m (6ft) length included
Power	100 – 240 VAC, 50 – 60 Hz, 25 W; on power loss all settings are retained without batteries
Dimensions HWD	Enclosures: 900 × 450 × 190 mm (35.4 × 17.7 × 7.5")
Weight	27 kg (60 lbs)
Ambient operating temperature	10 – 45 °C (50 – 113 °F)
Humidity	10 – 90% non-condensing
Ratings/approvals	CE, cULus

## Ordering Information

Description	Order No.
2300Na Sodium Analyzer, with partial door for clean sample room	58 042 001
2300Na Sodium Analyzer, with full dust & water resistant enclosure	58 042 002
Required Startup Kit 1 L of 100 ppm calibration standard solution, 250 mL of 7 and 10 pH buffer solutions and etch solutions	58 091 233*

\* Diisopropylamine (DIPA) reagent to be sourced locally.

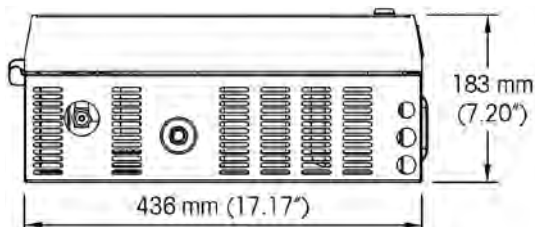

## 2850Si Silica Analyzer

### Intelligent, Flexible, Compact



The METTLER TOLEDO Thornton 2850Si Silica Analyzer is a compact and reliable on-line analyzer designed for measuring silica in pure/ultrapure water treatment and power cycle chemistry monitoring. It supports early detection of trace contamination with minimal operator supervision, proactively monitors reagent usage and reports time to maintenance. This analyzer offers optional built-in sequencing to support multiple sample streams and phosphate monitoring to ensure sufficient levels are maintained for optimal boiler water treatment.

#### Features/Benefits

- Automatic, unattended calibration provides excellent repeatability and saves operator time
- Automatic zeroing with every measurement ensures measurement stability
- Convenient grab sampling allows quality testing of remote samples
- Intelligent internal analytics ensure peak performance and minimal downtime
- Configurable simultaneous display of parameters including silica/phosphate levels and measurement timing
- Analog output with choice of scaling for integration into data acquisition system
- Available as panel assembly or with full enclosure that protects reagent containers and components from plant environment
- Small footprint simplifies upgrades and saves valuable panel space
- Lightweight, compact, simple-to-maintain design supports up to four sample streams

#### Typical Applications

- Anion exchange monitoring in pure water treatment detects the first breakthrough at very low ppb levels of silica to trigger regeneration and ensure contaminated water can be diverted before it reaches critical areas.
- Power steam quality monitoring protects turbines from silica deposition and resulting imbalance, loss of capacity and reduced efficiency. Silica measurement and control may also be needed to meet turbine manufacturer warranty requirements.
- At larger plants, monitoring silica levels at the economizer provides a final feed-water quality check before the pre-heated water enters the steam drum.
- When treating boiler water with phosphate, monitoring ppm levels is important for maintaining appropriate concentrations to control scale and protect against caustic corrosion.

## Specifications

### Measurements

Range	Silica: 0–5,000 ppb; Phosphate: 1–10 ppm
Resolution	4 digits with decimal, autoranging; 0.001 ppb in lowest range
Accuracy	Silica: $\pm 5\%$ of reading $\pm 1$ ppb; Phosphate: $\pm 10\%$ of reading
Measurement cycle time	Adjustable $\geq 10$ min; 20 min typical
Reagent consumption	Approx. 500 mL each per 3 months with 20 min measurement cycle time
Sample flow rate	50–250 mL/min
Sample temperature	5–60 °C (41–140 °F)
Sample pressure	0.3–7 bar (5–100 psig)
Zero calibration	Automatic, every measurement cycle
Span calibration	Automatic per schedule; once per month, typical
Grab sample measurement	500 mL capacity

### Outputs

Analog output	Powered 0/4–20 mA, 22 mA alarm, 500 ohm max load, not for use with externally powered circuit
Analog output accuracy	$\pm 0.05$ mA
Analog output scaling	Linear, bi-linear, logarithmic (1,2,3,4 decades), auto ranging
Relay contacts	Two unpowered, SPDT, 250 VAC/30 VDC, 3 A resistive, freely assignable to setpoint for silica; other relays used for measurement and auto-cal

### Installation/Power/Enclosure

Operator interface	TFT color touchscreen; simultaneous display of silica/phosphate concentration and measurement or auto-cal status
Process connections	Sample inlet: 6 mm or 1/4" OD tube SS compression fitting Drain hose: 19 $\times$ 25.4 mm ( $\frac{3}{4}$ $\times$ 1"), 2 m (6ft) length included
Power	100–240 VAC, 50–60 Hz, 100 W; on power loss all settings are retained without batteries
Dimensions HWD	Enclosure: 543 $\times$ 413 $\times$ 300 mm (21.4" $\times$ 16.3" $\times$ 11.8")
Weight	18 kg (40 lbs)
Ambient operating temperature	10–50 °C (50–122 °F)
Humidity	10–90% non-condensing
Ratings/approvals	CE, cULus

\* Specifications subject to change.

## Ordering Information

Description	Order No.
Analyzer 2850Si Silica, 1-stream	30 571 931
Analyzer 2850Si Silica, 2-stream	30 571 932
Analyzer 2850Si Silica, 4-stream	30 571 933
Analyzer 2850Si Silica, 1-stream with Phosphate	30 571 934
Analyzer 2850Si Silica, 2-stream with Phosphate	30 571 935
Analyzer 2850Si Silica, 4-stream with Phosphate	30 571 936
Analyzer 2850Si Silica, 1-stream Panel	30 571 937
Analyzer 2850Si Silica, 2-stream Panel	30 571 938
Analyzer 2850Si Silica, 4-stream Panel	30 571 939
Analyzer 2850Si Silica, 1-stream Panel with Phosphate	30 571 940
Analyzer 2850Si Silica, 2-stream Panel with Phosphate	30 571 941
Analyzer 2850Si Silica, 4-stream Panel with Phosphate	30 571 942
Reagent Kit,	30 571 930

3 month supply of reagents and 500 mL of 250 ppb silica calibration standard.



## 3000CS Chloride/Sulfate Analyzer

### High Sensitivity, On-line Measurement



The METTLER TOLEDO Thornton 3000CS Analyzer is a reliable on-line instrument designed to directly measure chlorides and sulfates in pure water and power cycle chemistry. This analyzer enables monitoring of these highly corrosive contaminants to assist in corrosion control and minimizing damage to critical plant equipment. Early, unambiguous detection of trace levels of these contaminants is enabled with minimal operator supervision.

#### Features/Benefits

- Intuitive touchscreen interface: allows display of trendlines for each measurement
- Simultaneous display of ion concentrations and measurement timing: provides convenient analyzer status at a glance, saving operator time
- Analog outputs with choice of scaling: enables easy integration into data acquisition systems
- Convenient grab sample capability: allows measurement of additional samples or for QC checks
- Full enclosure: protects reagent containers and components from plant environment

#### Typical Applications

- Steam quality monitoring at turbine inlet to ensure chloride and sulfate levels are under acceptable limits.
- Condensate monitoring at condensate polisher, to detect breakthrough or deterioration of sulfonated cation resin.
- Boiler feedwater monitoring, to activate boiler blowdown if needed to control contaminant levels.
- Makeup water quality.



## Specifications

### Measurements

Range	0–300 ppb
Limit of detection	Chloride: 0.5 ppb; Sulfate: 1 ppb
Accuracy	Chloride: $\pm 5\%$ of reading $\pm 0.5$ ppb, typical; Sulfate: $\pm 5\%$ of reading $\pm 1$ ppb
Measurement cycle time	45 min typical, programmable between 15 minutes and 1 hour
Sample flow rate	25–50 mL/min
Sample temperature	10–45 °C (50–113 °F)
Sample pressure	0.3–7 bar (5–100 psig)
Grab sample measurement	100 mL capacity

### Outputs

Analog outputs	8 powered 0/4–20 mA, 22 mA alarm, 500 ohm max load, not for use with externally powered circuit
Analog output accuracy	$\pm 0.05$ mA
Analog output scaling	Linear, bi-linear, logarithmic (1,2,3,4 decades), auto ranging
Relay contacts	Mechanical rated at 250 VAC, 3 Amps (Relay 1 NC, Relay 2 to 4 NO), 4-SPDT Type Reed 250 VAC or DC, 0.5 Amps (Relay 5 to 8)

### Installation/Power/Enclosure

Operator interface	Color touchscreen; simultaneous display of ion concentrations and analyzer status
Process connections	Sample inlet: ¼" or 6 mm OD tube SS compression fitting Drain hose: 19 × 25.4 mm (¾ × 1"), 2 m (6 ft) length included
Power	100–240 VAC, 50–60 Hz, 100 W typical
Dimensions HWD	927 × 508 × 305 mm (36.5" × 20.9" × 12")
Weight	44 kg (97 lbs)
Ambient operating temperature	10–35 °C (50–95 °F)
Humidity	10–70 % non-condensing
Ratings/approvals	CE, cULus

\* Specifications subject to change.

## Ordering Information

Description	Order No.
3000CS Analyzer	58 044 001
Required Startup Kit	58 091 400
Includes 2-month supply of reagents, cartridge, and calibration standard solution.	
Conditioning Resin Kit	30 416 018

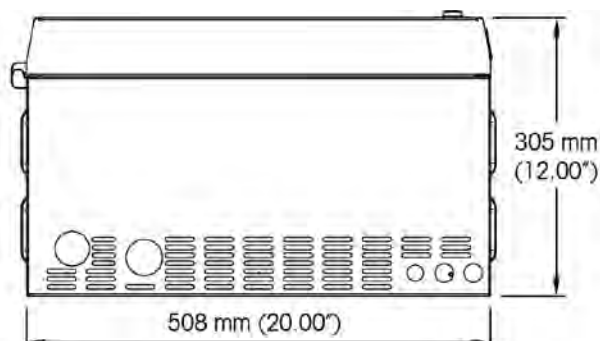

# Transmitters for All Parameters Your Access to Water Analytics

**Whether you require a multi-parameter, multi-channel, parameter specific or portable unit, METTLER TOLEDO's wide portfolio of globally-approved transmitters includes the right solution for you.**

### Constant information

Transmitters are the components that communicate to the user and translate sensor readings into displayed measurements for indication and control. METTLER TOLEDO provides tailorable transmitter solutions to meet the needs of a wide range of applications and functional requirements. Intelligent diagnostics keep users informed of sensor "health".

### Single- or multi-channel?

For simpler processes where only a single parameter requires measurement, a single-channel transmitter is the obvious choice, but for processes where more than one parameter must be monitored, multi-channel, multi-parameter transmitters offer significant advantages and value. METTLER TOLEDO multi-channel transmitters combine operating flexibility with ease of use.

### Communication

We offer transmitters for most common communication protocols for easy interface with your DCS or PLC. Intelligent Sensor Management (ISM) diagnostics data can also be accessed on control systems to provide an overview of the performance of all measurement systems from one point.



### The way forward

Use of digital sensors is becoming increasingly common in the process industries. Many of our transmitters accept traditional analog as well as ISM digital sensors, providing a future oriented investment in your plant.

Our latest transmitter developments include the M800 multi-parameter, multi-channel unit. Its large touchscreen

display and intuitive menus save operating time, while predictive maintenance ensures reliability and reduced maintenance. The M300 is flexible, price competitive and offers single and dual channel measurements with ISM or analog sensors. The M200 has been designed around one central requirement: ease-of-use. From system selection to commissioning, operation and maintenance,

all M200 system components are narrowly tailored to include only necessary functions. METTLER TOLEDO Thornton transmitters provide reliable performance for measuring conductivity, total organic carbon (TOC), pH, ORP, dissolved oxygen, dissolved ozone and flow.



	M200 (p. 202–205)	M300 Water (p. 206–209)	M400 (p. 84–87)	M800 Water (p. 210–211)
<b>Channels</b>	1/2	1/2	1	2/4
<b>Plug and Measure</b>	•	•	•	•
<b>Dynamic Lifetime Indicator (DLI)</b>	–	•	•	•
<b>Adaptive Calibration Timer (ACT)</b>	–	•	•	•
<b>Time To Maintenance (TTM)</b>	–	•	•	•
<b>Calibration history</b>	–	•	•	•
<b>iMonitor</b>	–	•	•	•
<b>CIP/SIP/autoclaving counter</b>	–	•	•	•
<b>Power plant calc parameters</b>	•	•	–	•
<b>USP/EP conductivity setpoints</b>	•	•	•	•
<b>Di-Cap™</b>	–	–	–	•
<b>Communication</b>	–	–	HART	Profibus DP
<b>Panel cutout</b>	½ DIN, ¼ DIN	½ DIN, ¼ DIN	½ DIN	½ DIN
<b>Mixed-mode input</b>	–	•	•	–
<b>PID controller</b>	–	•	•	•
<b>Hold input</b>	•	•	•	•
<b>Analog input</b>	–	–	**	•
<b>Relays</b>	2	4	4	4/8
<b>Analog outputs</b>	2/4	2/4	4	4/8
<b>USB data logging</b>	–	•	•	–
<b>Transmitter Configuration Tool (TCT)</b>	•	•	•	•
<b>Approvals</b>	cULus, CE	cULus, CE	cCSAus Cl 1 Div 2, ATEX Zone 2, CE, NEPSI	cULus, CE
<b>Parameter compatibility (water)</b>				
<b>pH/ORP/pNa</b>	•	•	•	•
<b>Dissolved oxygen</b>				
Amperometric sensors				
Low (High Performance)	•	•	**	•
Optical sensors				
Low (pure ODO)	–	–	**	•
<b>TOC</b>	–	–	–	•
<b>Conductivity 2-e/4-e (analog)</b>	–	•	•	–
<b>UniCond 2-e/4-e</b>	•	•	•	•
<b>Dissolved ozone</b>	•	•	**	•
<b>Flow*</b>	•	–	–	•

\* Each M800 has two pulse flow input channels. Additional flow sensors can be connected using optional pulse flow adapter. Flow is available on selective M200 models.

\*\* Model specific

## M200: Convenient and Reliable For Basic Water Applications



The METTLER TOLEDO M200 transmitter line provides an exceptional ease-of-use interface for digital conductivity, pH, ORP, dissolved oxygen and ozone measurement. From system selection to commissioning, operation and maintenance, all system components are designed to eliminate any unnecessary functions. Plug and Measure provides maximum compatibility and easy operation for digital sensor operation. Simply connect selected digital ISM or unique to M200 digital easySense sensors and the transmitter does the rest.

### Specifications

#### Enclosure / Power

Operator interface	4 line backlit LCD; 5 tactile keys
Material	Polycarbonate
Weight, ¼ DIN models	0.7 kg (1.5 lb)
Weight, ½ DIN models	1 kg (2.2 lb)
UL electrical environment	Installation (overvoltage) Category II
Ratings/approvals	UL (US & Canada), CE compliant; ¼ DIN: IP 65 (front); ½ DIN: IP 65/UL 4X
EMC emissions	EN61226-1:2013 Class A
Power	Universal 100–240 VAC, 50–60 Hz or 20–30 VDC; 5 W

#### Outputs

Analog outputs (as specified for individual models)	Powered 0/4–20 mA, 22 mA alarm, 500Ω maximum load; not for use with externally powered circuits
Analog output accuracy	±0.05 mA
Analog output scaling	Linear, bi-linear, logarithmic (1,2,3 or 4 decades), auto-ranging
Relays (as specified for individual models)	All contacts are potential free, with adjustable hysteresis and time delay SPDT, SPST NO, SPST NC: 250 VAC/30 VDC, 3 A, resistive SPST reed: 300 VDC, 0.5 A, 10 W
Flow models only	
Service interface	USB, type B connector, for remote configuration and commissioning
Discrete input (as specified individual models)	Accepts dry contact closure for remote flow totalizer reset or for remote PID control auto/manual selection

### Other Highlights

- Digital easySense and ISM sensor compatibility
- Quick setup mode for fast installation
- Digital, backlit, high contrast display

### Features Overview

- Multi-parameter allows up to two user-configurable channels with pre-calibrated sensors
- Selectable conductivity temperature compensation on/off and USP alarm capabilities
- Multi-level password protection against accident accidental changes
- Transmitter Configuration Tool (TCT) software included, for fast, simple and consistent transmitter programming via USB port

► [www.mt.com/M200](http://www.mt.com/M200)

## Transmitter Specifications

Outputs		
pH/ORP/Cond/DO/Ozone/Temperature	Single-channel	Two-channel
Setpoints/alarms	4-high, low, outside, between, USP, EP	6-high, low, outside, between, USP or EP
Relays	2 SPDT	2 SPDT
Analog output signals	2	4
Discrete inputs	1	2
Flow	Single-channel	Four-channel
Setpoints/alarms	4-high, low, outside, or between	8-high, low, outside, or between
Relays	2 SPDT, 1 SPST NO, 1 SPST NC	2 SPDT, 1 SPST NO, 1 SPST NC
Analog output signals	2	4
Discrete inputs, for external totalizer reset	1	2

## Flow Transmitter Specifications

Flow rate range	0 to 9999 GPM, L/min, m <sup>3</sup> /hr
Total flow range	0 to 9,999,999 Gallons, 37,850,000 Liters, 37,850 m <sup>3</sup>
RO % recovery range	0 to 100 %
Flow velocity range	Equivalent ft/s, m/s
Frequency range	1 to 4000 Hz
Calculated parameters	Ratio, sum and difference of two flowrates (4-channel)
Resolution	4 significant digits, auto-ranged; up to 8 digits for total flow
Update rate	Display and outputs, once per 2 s
Input pulses	Low < 1.0 volt; high > 1.4 volts (36 volts max.)
Accuracy	± 0.5 Hz
Repeatability	± 0.2 Hz

## Measurement Specifications

See ISM sensor pages for specifications: conductivity pages 152–155, pH/ORP pages 162–171, dissolved oxygen pages 172–177 (note optical dissolved oxygen is not compatible with M200), and dissolved ozone page 178–179.

### M200 Digital easySense Measurement Specifications (only compatible with M200 transmitter models)

#### Selected specifications of easySense conductivity sensors

	71	72	73	77
Type	2-electrode	2-electrode	2-electrode	4-electrode
Cell constant	0,1 cm <sup>-1</sup>	0,1 cm <sup>-1</sup>	0,1 cm <sup>-1</sup>	0.3 cm <sup>-1</sup>
Measuring range	0.01 – 2000 µS/cm	0.01 – 2000 µS/cm	0.01 – 2000 µS/cm	0.02 – 400 mS/cm
System accuracy	± 3.0 % or better	± 3.0 % or better	± 3.0 % or better	± 5.0 % or better
Temperature compensation	standard high purity, cation, ammonia, Light 84, isopropanol, glycol			
Temperature sensor	30 kOhm NTC	30 kOhm NTC	30 kOhm NTC	30 kOhm NTC
Electrode material	Titanium	Titanium	Titanium	1.4404 SS (316L)
Insertion fitting	¾" NPT	½" NPT	¾" NPT & subm.	¾" NPT
Cable length/Order number				
– 7.6 m (25 ft)	58 031 300	58 031 302	58 031 304	–
– 30.5 m (100 ft)	58 031 301	58 031 303	58 031 305	–
– K8S connector	–	–	–	52 003 810

# Transmitters

Outstanding Performance, Advanced Electronics

## M200 Digital easySense Measurement Specifications (only compatible with M200 transmitter models) continued

### Selected specifications of easySense pH / ORP, and oxygen sensors

	<b>31</b>	<b>32</b>	<b>33</b>	<b>34</b>	<b>41</b>	<b>21</b>
Parameter	pH	pH	pH	pH	ORP	Oxygen
Measurement range	0–14	0–14	0–14	0–14	± 1500 mV	0.03 ppm – 100% saturation
Temperature	–5–80 °C (23–176 °F)	–5–80 °C (23–176 °F)	–5–80 °C (23–176 °F)	–5–80 °C (23–176 °F)	–5–80 °C (23–176 °F)	0–60 °C (32–140 °F)
Pressure resistance	0–2 barg (0–29 psig)	0–2 barg (0–29 psig)	0–2 barg (0–29 psig)	0–2 barg (0–29 psig)	0–2 barg (0–29 psig)	0.5–2 barg (7–29 psig)
Pressure resistance 0–40 °C (32–104 °F)	0–6 barg (0–87 psig)	–	–	–	0–6 barg (0–87 psig)	–
Reference system	Argenthal (Ag/AgCl)	Argenthal (Ag/AgCl)	Argenthal (Ag/AgCl)	Argenthal (Ag/AgCl)	Argenthal (Ag/AgCl)	–
Reference electrolyte	Gel	Pressurized gel	Pressurized gel	Pressurized gel	Polymer	–
Diaphragm	1 ceramic	1 ceramic	1 ceramic	1 ceramic	Open junction	–
Membrane glass	HA	HA	HF	LoT	– (Platinum ring)	–
Application	General purpose	Harsh processes	HF resistant	Low temperature	General purpose	General purpose
Plug head	K8S, Pg 13.5	K8S, Pg 13.5	K8S, Pg 13.5	K8S, Pg 13.5	K8S, Pg 13.5	K8S, Pg 13.5
Order number	52 003 771	52 003 768	52 003 770	52 003 769	52 003 772	52 206 406

### Selected specifications of easy housings

	<b>easyFit™ 21</b>	<b>easyFit 22</b>	<b>easyFlow™ 21, 22</b>	<b>easyFlow 23</b>	<b>easyDip™ 21, 22</b>
Material	CPVC	Stainless Steel	CPVC	Polysulfone	PVC
Temperature	–5–80 °C (23–176 °F)	–5–100 °C (23–212 °F)	–5–80 °C (23–176 °F)	–5–130 °C (23–266 °F)	0–60 °C (32–140 °F)
Max pressure at	7.0 barg/65 °C 3.5 barg/80 °C (100 psig/149 °F) (50 psig/176 °F)	10 barg/100 °C (145 psig/212 °F)	3.5 barg/80 °C (50 psig/176 °F)	7.0 barg/130 °C (100 psig/266 °F)	ambient
Order Number	52 403 951	52 403 952	<b>easyFlow 21:</b> 52 403 953 <b>easyFlow 22:</b> 52 403 954	52 403 955	<b>easyDip 21:</b> 52 403 956 <b>easyDip 22:</b> 52 403 957
– US size					
– Metric size					

### Ordering Information

Description		Order Number	Order Number
M200 Digital Transmitter	Outputs	¼ DIN	½ DIN
M200 1-channel Multi-parameter	2 Analog; 2 Relays	52 121 554	52 121 555
M200 2-channel Multi-parameter	4 Analog; 2 Relays	52 121 556	52 121 557
M200 Flow 1-channel	2 Analog; 4 Relays	30 280 748	–
M200 Flow 4-channel	4 Analog; 4 Relays	30 280 749	–

### Sensor Cables for ISM

Conductivity	Order Number
0.3 m (1 ft)	58 080 270
1.5 m (5 ft)	58 080 271
3.0 m (10 ft)	58 080 272
4.5 m (15 ft)	58 080 273
7.6 m (25 ft)	58 080 274
15.2 m (50 ft)	58 080 275
30.5 m (100 ft)	58 080 276
45.7 m (150 ft)	58 080 277
61.0 m (200 ft)	58 080 278
91.4 m (300 ft)	58 080 279
pH/DO/Ozone	Order Number
1.0 m (3 ft)	59 902 167
3.0 m (10 ft)	59 902 193
5.0 m (16 ft)	59 902 213
10.0 m (33 ft)	59 902 230
Accessories	Order Number
Panel mount kit for ½ DIN models	52 500 213
Pipe mount kit for ½ DIN models	52 500 212
Adapter, VP to standard, for calibrating conductivity with VP patch cord (analog)	58 080 102
Adapter panel – M200 ¼ DIN to 200CR/2000 cutout	58 083 305

## M300 Water: Versatile and User-Friendly For a Wide Range of Applications and Industries



The multi-parameter M300 Water transmitter line for digital or analog conductivity/resistivity, pH/ORP, dissolved oxygen and ozone measurements offers exceptional measurement performance with excellent user ergonomics.

The high contrast black and white touchscreen display together with the harmonized menu structure for all parameters provides clear indication, with trending capabilities, facilitates navigation while ensuring easy, user-friendly operation. On-line diagnostics information, such as the Dynamic Lifetime Indicator, allows operators to schedule sensor maintenance or replacement. The clearly visible diagnostic information tells you when it's time to do maintenance or calibration of sensors with Intelligent Sensor Management (ISM) technology.

The integrated USB interface allows for data logging or storage of the configuration on a USB flash drive.

### Specifications

Power supply	80 to 255 VAC, or 20 to 30 VDC, 10 VA
Frequency for AC	50 to 60 Hz
Current output	2 × 0/4 to 20 mA (4 × for dual channel), 22 mA alarm (according to Namur NE43)
Display	4.0" b/w touchscreen, 320 × 240 pixel
Languages	9 (English, German, French, Italian, Spanish, Portuguese, Russian, Japanese and Chinese)
Ambient temperature	-10 to 50 °C (14 to 122 °F)
Relative humidity	0 to 95% non-condensing
Rating	¼ DIN: IP65 (front) ½ DIN: IP65
PID controller	Yes
Control input (Hold)	1 or 2 (dual channel version)
Relays	2 × SPST, 2 × reed
Approvals and certificates	cULus, CE
USB interface	1 × USB Host: Data logging and configuration storage on USB flash drive 1 × USB Device: Software update interface

### Other Highlights

- Mixed-mode functionality allows the connection of analog or digital ISM sensors
- Full ISM diagnostics available (for ISM sensors)

### Features Overview

- 4.0" touchscreen interface/display
- Multi-parameter transmitter for conductivity/resistivity, pH/ORP, dissolved oxygen, and ozone
- Available as single-channel or dual-channel transmitters
- PID controller with pulse length, pulse frequency or analog control
- User management available

▶ [www.mt.com/M300](http://www.mt.com/M300)



## Measurement Specifications

Conductivity/Resistivity	Analog	ISM
Ranges	0.01 constant sensor: 0.002 to 200 $\mu\text{S}/\text{cm}$ 0.1 constant sensor: 0.02 to 2,000 $\mu\text{S}/\text{cm}$ 10 constant sensor: 50 to 40,000 $\mu\text{S}/\text{cm}$ 4-electrode sensor: 0.01 to 650 $\text{mS}/\text{cm}$	0.002 to 500 $\mu\text{S}/\text{cm}$ 0.02 to 50,000 $\mu\text{S}/\text{cm}$ * 0.01 to 1,000 $\text{mS}/\text{cm}$
Accuracy	$\pm 0.5\%$ of reading or $0.5\Omega$ , whichever is greater (analog only)	
Concentration ranges of HCl, NaOH, H <sub>2</sub> SO <sub>4</sub>	0–20 %, 0–15 %, 0–20 %	
TDS ranges (CaCO <sub>3</sub> and NaCl)	Cover equivalent conductivity ranges	
Calculated parameters (2-channel)	% Rejection, power plant calculations of pH based on specific and cation conductivity, and CO <sub>2</sub> based on cation and degassed conductivity	
Temperature compensation	Selectable as: Std (standard high purity Thornton/Light), Light 84, Std referenced to 75 °C, linear %/°C, 50 % glycol, 100 % glycol, cation, ammonia, isopropyl alcohol, none	
<b>pH</b>		
pH, ORP ranges	–1.00 to 15.00 pH, –1500 to 1500 mV	
Temperature range	–30 to 100 °C (–22 to 212 °F)	
Accuracy	$\pm 0.03$ pH, $\pm 2$ mV	
Temperature compensation	Automatic/manual for electrode output, plus adjustable solution temperature coefficient for solution ionization effects	
Calibration	1- or 2-point, with auto buffer recognition	
Diagnosics	Selectable continuous checking of membrane resistance and reference diaphragm/junction resistance (with solution ground sensors)	
<b>Dissolved Oxygen</b>		
Ranges	0–20,000 ppb; 0–20 ppm, 0–200 % saturation; resolution 0.1 ppb	
Temperature compensation	Automatic, for membrane permeability and oxygen solubility	
Accuracy	$\pm 1\%$ of reading or $\pm 1$ ppb, system accuracy	
<b>Dissolved Ozone</b>		
Ranges	0–5,000 ppb, 0–5 ppm; resolution 0.1 ppb	
Temperature compensation	Automatic, for membrane permeability and ozone solubility	
Accuracy	$\pm 2\%$ of reading or $\pm 3$ ppb, system accuracy	
<b>Temperature</b>		
Range	–40 to 200 °C (–40 to 392 °F); resolution 0.1 °	
Accuracy	$\pm 0.25$ °C ( $\pm 0.45$ °F)	
Resolution	0.01 °C for conductivity; 0.1 °C for all other parameters	
<b>PID Control</b>		
Display	Auto/manual status and %–output on bottom line of display	
Settings	Auto/manual, setpoint, deadband, non-linear corner points, control limits, proportional gain, integral reset time (min), derivative rate time (min)	
Manual station	Controlled by up/down arrow keys in manual mode; remote auto/manual selection by discrete input	
Control output types	One or two analog signals, relays-pulse frequency, or relays-pulse length	

\* stainless steel sensors 0.02 to 3,000  $\mu\text{S}/\text{cm}$

# Transmitters

Outstanding Performance, Advanced Electronics

Transmitters

## Measurement Specifications (cont.)

<b>Outputs</b>		
<b>pH/ORP/Cond/DO/Ozone/Temperature</b>	<b>Single-channel</b>	<b>Two-channel</b>
Setpoints/alarms	4-high, low, outside, between, USP, EP	6-high, low, outside, between, USP or EP
Relays	1 SPST NO, 1 SPST NC, 2 SPST reed	1 SPST NO, 1 SPST NC, 2 SPST reed
Analog output signals	2	4
Discrete inputs	1	2

## Ordering Information

<b>Description</b>	<b>Order Number</b>
M300 Water 1-channel, Multi-parameter, ¼ DIN	30 280 776
M300 Water 1-channel, Multi-parameter, ½ DIN	30 280 777
M300 Water 2-channel, Multi-parameter, ¼ DIN	30 280 778
M300 Water 2-channel, Multi-parameter, ½ DIN	30 280 779
M300 Water 2-channel, Cond/Res Analog, ¼ DIN	30 280 774
M300 Water 2-channel, Cond/Res Analog, ½ DIN	30 280 775

## Accessories

<b>Installation accessories for ½ DIN version</b>	<b>Order Number</b>
Pipe mount kit for ½ DIN	30 300 480
Panel mount kit for ½ DIN	30 300 481
Wall mounting kit for ½ DIN	30 300 482
Protective hood	30 073 328

## Ordering Information

### Sensor Cables for M300 (analog)

Conductivity <sup>a</sup>	Order Number	
Connector	Standard	VarioPin (VP) <sup>b</sup>
0.3m (1ft)	58 080 250	–
1.5m (5ft)	58 080 251	58 080 201
3.0m (10ft)	58 080 252	58 080 202
4.5m (15ft)	58 080 253	58 080 203
7.6m (25ft)	58 080 254	58 080 204
15.2m (50ft)	58 080 255	58 080 205
23.0m (75ft)	–	58 080 206
30.5m (100ft)	58 080 256	58 080 207
46.0m (150ft)	58 080 257	58 080 208
61.0m (200ft)	58 080 258	58 080 209
ORP		
1.0m (3ft)	59 902 245	
3.0m (10ft)	59 902 268	
5.0m (16ft)	59 902 292	
10.0m (33ft)	59 902 318	

<sup>a</sup> 4-E sensors limited to 15.2m (50ft), <sup>b</sup> For VP Conductivity sensors only

### Sensor Cables for M300 ISM

Conductivity	Order Number
0.3m (1ft)	58 080 270
1.5m (5ft)	58 080 271
3.0m (10ft)	58 080 272
4.5m (15ft)	58 080 273
7.6m (25ft)	58 080 274
15.2m (50ft)	58 080 275
30.5m (100ft)	58 080 276
45.7m (150ft)	58 080 277
61.0m (200ft)	58 080 278
91.4m (300ft)	58 080 279

pH/DO/Ozone	Order Number
VarioPin (VP) Cables	
– for Use At Standard Temperatures –30 to 80 °C / –22 to 176 °F	
1.0m (3ft)	52 300 107
3.0m (10ft)	52 300 108
5.0m (16ft)	52 300 109
10.0m (33ft)	52 300 110
15.0m (49ft)	52 300 144
20.0m (65ft)	52 300 141

pH/DO/Ozone	Order Number
1.0m (3ft)	59 902 167
3.0m (10ft)	59 902 193
5.0m (16ft)	59 902 213
10.0m (33ft)	59 902 230

# M800 Multi-Parameter, Multi-Channel Transmitter

## Touch the Future



The M800 transmitter series features premium Intelligent Sensor Management (ISM) technology measuring conductivity/resistivity, TOC, pH/ORP, optical and amperometric, dissolved oxygen, dissolved ozone. The multi-parameter transmitter accepts any compatible combination of ISM sensors. Up to four channels of process measurement plus two pulse flow measurements provides immediate Plug and Measure installation and operation, predictive sensor maintenance and dynamic lifetime status. The color touchscreen ensures intuitive operation, with user selectable control and alarm management. One model available with PROFIBUS-DP digital communications.



### Features Overview

- Color touchscreen
- Intuitive operation
- Premium ISM functionality
- Multi-parameter measurement
- 2-channel / 4-channel versions
- iMonitor predictive diagnostics
- User management and logbook
- Trend display

### Other Highlights

- 8 current outputs
- 8 output relays
- Traffic light coded sensor status
- 2 PID process controller
- PROFIBUS-DP model
- IP66 rated, cULus Type 4X

### Specifications

Performance	
Measurement parameters	Conductivity/resistivity, TOC, pH/ORP, dissolved oxygen, ozone, temperature and flow
ISM	Advanced diagnostics (Dynamic Lifetime Indicator, Adaptive Calibration Timer, CIP/SIP counter etc.) iMonitor
Conductivity/Resistivity	
Conductivity ranges (C = cell constant)	<b>2-electrode sensor:</b> C = 0.1: 0.01 to 50,000 µS/cm (20 Ω × cm to 50 MΩ × cm) C = 0.1 sanitary: 0.01 to 3,000 µS/cm (333 Ω × cm to 50 MΩ × cm) C = 0.01: 0.001 to 500 µS/cm (2,000 Ω × cm to 500 MΩ × cm) <b>4-electrode sensor:</b> 0.01 to 1,000 mS/cm (1.0 Ω × cm to 0.1 MΩ × cm)
Temperature measuring range	-40 to 200 °C (-40 to 392 °F)
Temperature compensation	Auto/selectable as: Std. (standard high purity water Thornton/Light), Light 84, Std. pure water referenced to 75 °C, linear %/°C (adjustable), 50 % glycol, 100 % glycol, cation, ammonia, isopropyl alcohol, none
TOC	
Measurement range	0.05 – 2000 ppbC (µgC/L)
pH	
pH range	-1 to 15
ORP input range	-1500 to 1500 mV
pH resolution	Auto/0.001/0.01/0.1/1 (can be selected)
Temperature measuring range	-30 to 150 °C (-22 to 302 °F)
Temperature compensation	Auto/manual/STC
Oxygen	
Range (amperometric)	0 to 10,000 ppb (µg/L)
Range (optical)	0 to 5,000 ppb (µg/L)
Oxygen resolution	Auto/0.001/0.01/0.1/1 (can be selected)
Temperature compensation	Auto
Ozone	
Operating range	0–5,000 ppb (µg/L); 0–5.0 ppm (mg/L) short term; 0–500 ppb (µg/L); 0–0.5 ppm (mg/L) continuous

[www.mt.com/M800](http://www.mt.com/M800)

## General Specifications

Power supply	100 to 240VAC, or 20 to 30VDC, 12 VA
AC frequency	50 to 60 Hz
Current (analog) outputs	8 × 0/4 to 20 mA, 22 mA alarm
Bus communications	PROFIBUS-DP
User interface	Color touchscreen 5.7", Resolution 320 × 240 px, 256 colors
Languages	10 (English, German, French, Italian, Spanish, Portuguese, Russian, Japanese, Korean and Chinese)
Ambient temperature	–20 to 50 °C (–4 to 122 °F)
Relative humidity	0 to 95 %, non-condensing
Rating	IP 66 (when back cover is attached), cULus Type 4X
PID process controller	2
Hold input	Yes
Control input	Yes
Alarm contact	Yes (alarm delay 0 to 999 s)
Relays	Mechanical rated at 250VAC, 3 Amps (Relay 1 NC, Relay 2 to 4 NO); 4 – SPDT Type Reed 250 VAC or DC, 0.5 Amps (Relay 5 to 8)
Setpoints	High, low, between, outside, USP, EP

## Ordering Information

Transmitters	Order Number
M800 Water 2-channel + 2 flow	58 000 802
M800 Profibus DP Water 2-channel + 2 flow	58 000 806
M800 Water 4-channel + 2 flow	58 000 804
Installation Accessories	
Pipe mount kit	52 500 212
Panel mount kit	52 500 213
Protective hood	30 073 328

## ISM Sensor Cables

Conductivity/TOC	Order Number
0.3 m (1 ft)	58 080 270
1.5 m (5 ft)	58 080 271
3.0 m (10 ft)	58 080 272
4.5 m (15 ft)	58 080 273
7.6 m (25 ft)	58 080 274
15.2 m (50 ft)	58 080 275
30.5 m (100 ft)	58 080 276
45.7 m (150 ft)	58 080 277
61.0 m (200 ft)	58 080 278
91.4 m (300 ft)	58 080 279

pH/DO*/O <sub>3</sub>	Order Number
1.0 m (3 ft)	59 902 167
3.0 m (10 ft)	59 902 193
5.0 m (16 ft)	59 902 213
10.0 m (33 ft)	59 902 230
20.0 m (66 ft)	52 300 204
30.0 m (98 ft)	52 300 393
50.0 m (164 ft)	52 300 394
80.0 m (264 ft)	52 300 395

\* Except optical DO

## Optical DO

Sensor Cables	Order Number
2 m (6.6 ft)	52 300 379
5 m (16.4 ft)	52 300 380
10 m (32.8 ft)	52 300 381
15 m (49.2 ft)	52 206 422

## Trademark Information

METTLER TOLEDO, the METTLER TOLEDO logo, INGOLD and THORNTON are trademarks of the METTLER TOLEDO Group.

ISM, iSense, iMonitor, InPro, InDip, InTrac, InTap, InFlow, iLink, GPro, Pro2Go, OptoCap, MembraCap, CalBox, CaliCap, UniCond, 7000RMS, pHure Sensor, pureO<sub>3</sub>, MaxCert, WideRange, Tri-Lock, EasyClean, easySense, easyFit, easyFlow, easyDip, Argenthal, FriscoLyt, ViscoLyt and XeroLyt are trademarks of the METTLER TOLEDO Group.

Viton and Kalrez are registered trademarks of DuPont Performance Elastomers LLC.

All other trademarks are the property of their respective holders.

**Sales and Service:****Australia**

Mettler-Toledo Limited  
220 Turner Street, Port Melbourne,  
VIC 3207 Australia  
Phone +61 1300 659 761  
e-mail info.mtaus@mt.com

**Austria**

Mettler-Toledo Ges.m.b.H.  
Laxenburger Str. 252/2  
AT- 1230 Wien  
Phone +43 1 607 4356  
e-mail prozess@mt.com

**Brazil**

Mettler-Toledo Ind. e Com. Ltda.  
Avenida Tamboré, 418, Tamboré  
BR- 06460-000 Barueri/SP  
Phone +55 11 4166 7400  
e-mail mtbr@mt.com

**Canada**

Mettler-Toledo Inc.  
2915 Argentia Rd #6  
CA- ON L5N 8G6 Mississauga  
Phone +1 800 638 8537  
e-mail ProInsideSalesCA@mt.com

**China**

Mettler-Toledo International Trading  
(Shanghai) Co. Ltd.  
589 Gui Ping Road, Cao He Jing  
CN- 200233 Shanghai  
Phone +86 21 64 85 04 35  
e-mail ad@mt.com

**Croatia**

Mettler-Toledo d.o.o.  
Prodaja/servis procesna analitika  
Procesna analitika, laboratorijska  
analitika, termalna analiza  
Jure Kaštelana 19, HR- 10000 Zagreb  
Phone +385 0(1) 2920 633  
e-mail mt.zagreb@mt.com

**Czech Republic**

Mettler-Toledo s.r.o.  
Trebohosticka 2283/2  
CZ- 100 00 Praha 10  
Phone +420 226 808 150  
e-mail sales.mtcz@mt.com

**Denmark**

Mettler-Toledo A/S  
Naverland 8  
DK- 2600 Glostrup  
Phone +45 43 27 08 00  
e-mail info.mtdk@mt.com

**France**

Mettler-Toledo S.A.S.  
18/20 avenue de la Pépinière  
FR- 78220 Viroflay  
Phone +33 1 30 97 17 17  
e-mail mtpro-f@mt.com

**Germany**

Mettler-Toledo GmbH  
Prozeßanalytik  
Ockerweg 3, DE- 35396 Gießen  
Phone +49 641 507 444  
e-mail prozess@mt.com

**Great Britain**

Mettler-Toledo LTD  
64 Boston Road, Beaumont Leys  
GB- Leicester LE4 1AW  
Phone +44 116 235 7070  
e-mail enquire.mtuk@mt.com

**Hungary**

Mettler-Toledo Kereskedelmi KFT  
Késmárk u. 14/B  
HU- 1158 Budapest  
Phone +36 1 288 40 40  
e-mail Order.MT-HU@mt.com

**India**

Mettler-Toledo India Private Limited  
Amar Hill, Saki Vihar Road, Powai  
IN- 400 072 Mumbai  
Phone +91 22 4291 0111  
e-mail sales.mtin@mt.com

**Indonesia**

PT. Mettler-Toledo Indonesia  
GRHA PERSADA 3<sup>rd</sup> Floor  
Jl. KH. Noer Ali No. 3A  
Kayuringin Jaya  
Kalimalang, Bekasi 17144, ID  
Phone +62 21 294 53919  
e-mail  
mt-id.customersupport@mt.com

**Italy**

Mettler-Toledo S.p.A.  
IT- Milan  
Phone +39 02 333 321  
e-mail customercare.italia@mt.com

**Japan**

Mettler-Toledo K.K.  
Process Division  
6F Ikenohata Nisshoku Bldg.  
2-9-7, Ikenohata, Taito-ku  
JP- 110-0008 Tokyo  
Phone +81 3 5815 5515  
e-mail jp01.helpdesk@mt.com

**Malaysia**

Mettler-Toledo (M) Sdn Bhd  
Bangunan Electroscon Holding, U 1-01  
Lot 8 Jalan Astaka U8/84  
Seksyen U8, Bukit Jelutong  
MY- 40150 Shah Alam Selangor  
Phone +60 3 78 44 58 88  
e-mail Sales.my@mt.com

**Mexico**

Mettler-Toledo S.A. de C.V.  
Ejército Nacional #340  
Polanco V Sección, C.P. 11560  
MX- México D.F.  
Phone +52 55 1946 0900  
e-mail mt.mexico@mt.com

**New Zealand**

Mettler-Toledo Limited  
18a Maui Street  
Pukekohe, Te Rapa  
Hamilton 3200 New Zealand  
Phone +64 800 722 648  
e-mail info.mtnz@mt.com

**Norway**

Mettler-Toledo AS  
Ulvenveien 92B  
NO- 0581 Oslo Norway  
Phone +47 22 30 44 90  
e-mail info.mtn@mt.com

**Philippines**

Mettler-Toledo Philippines Inc.  
6F JD Towers, Commerce Ave.  
Madrigal Business Park  
Ayala Alabang  
Muntinlupa 1780 Philippines  
Phone +632-5288900  
e-mail  
MT-PH.CustomerSupport@mt.com

**Poland**

Mettler-Toledo (Poland) Sp.z.o.o.  
ul. Poleczki 21  
PL- 02-822 Warszawa  
Phone +48 22 440 67 00  
e-mail polska@mt.com

**Russia**

Mettler-Toledo Vostok ZAO  
Sretensky blvd. 6/1, Office 6  
RU- 101000 Moscow  
Phone +7 495 621 56 66  
e-mail inforus@mt.com

**Singapore**

Mettler-Toledo (S) Pte. Ltd.  
Block 28, Ayer Rajah Crescent # 05-01  
SG- 139959 Singapore  
Phone +65 6890 00 11  
e-mail  
mt.sg.customersupport@mt.com

**Slovakia**

Mettler-Toledo s.r.o.  
Hattalova 12/A  
SK- 831 03 Bratislava  
Phone +421 2 4444 1221  
e-mail predaj@mt.com

**Slovenia**

Mettler-Toledo d.o.o.  
Pot heroja Trtnika 26  
SI-1261 Ljubljana-Dobrunje  
Phone +386 1 547 49 05  
e-mail darko.divjak@mt.com

**South Korea**

Mettler-Toledo (Korea) Ltd.  
5F, 155, Songpa-daero, Songpa-gu  
Seoul, Republic of Korea (05885)  
Phone +82 2 1588 0180  
e-mail helpdesk.korea@mt.com

**Spain**

Mettler-Toledo S.A.E.  
C/Miguel Hernández, 69-71  
ES- 08908 L'Hospitalet de Llobregat  
(Barcelona)  
Phone +34 902 32 00 23  
e-mail mtemkt@mt.com

**Sweden**

Mettler-Toledo AB  
Virkesvägen 10, Box 92161  
SE- 12008 Stockholm  
Phone +46 8 702 50 00  
e-mail sales.mts@mt.com

**Switzerland**

Mettler-Toledo (Schweiz) GmbH  
Im Langacher, Postfach  
CH- 8606 Greifensee  
Phone +41 44 944 47 47  
e-mail ProSupport.ch@mtf.com

**Thailand**

Mettler-Toledo (Thailand) Ltd.  
272 Soi Soonvijai 4  
Rama 9 Rd., Bangkapi, Huay Kwang  
TH- 10310 Bangkok  
Phone +66 2 723 03 00  
e-mail  
MT-TH.CustomerSupport@mt.com

**Turkey**

Mettler-Toledo Türkiye  
Haluk Türksoy Sokak No: 6 Zemin ve 1.  
Bodrum Kat  
34662 Üsküdar - Istanbul, TR  
Phone +90 216 400 20 20  
e-mail sales.mtr@mt.com

**USA**

METTLER TOLEDO  
Process Analytics  
900 Middlesex Turnpike, Bld. 8  
Billerica, MA 01821, USA  
Phone +1 781 301 8600  
Freephone +1 800 510 7873  
e-mail mtprous@mt.com

**Vietnam**

Mettler-Toledo (Vietnam) LLC  
G Floor, SCS Building, Plot T2-4  
D1 Street, Saigon Hi-tech Park  
Tan Phu Ward, District 9  
Ho Chi Minh City, Vietnam  
Phone +84 28 73 090 789  
e-mail  
MT-VN.CustomerSupport@mt.com

# The Information You Want is at [www.mt.com/pro](http://www.mt.com/pro)

The METTLER TOLEDO Process Analytics website contains a vast amount of up-to-date information on all our products and services. Content is localized for your country and tailored to suit your selections. Simple layout allows you to quickly find the information and features you are looking for.



Visit our website for fast and competent information.

- Learn about our most recent product developments
- Register for free webinars
- Request further information on products and services
- Obtain a quote quickly and easily
- Download our latest white papers
- Read case studies relevant to your industry
- Access buffer and electrolyte solution certificates

[www.mt.com/pro](http://www.mt.com/pro)

Visit for more information

## METTLER TOLEDO Group

Process Analytics

Local contact: [www.mt.com/pro-MOs](http://www.mt.com/pro-MOs)

Subject to technical changes

© 01/2020 METTLER TOLEDO

All rights reserved. PA0001en

Printed in Switzerland. 52 900 315